



# TEILELISTE

Part list

**Kurznaht-Automat**

Automatic short seamer

**BASS 5350**

Tel. 0049 6028/9916-0

Fax 0049 6028/9916-20

info@assag.de  
[www.assag.de](http://www.assag.de)



<b>BENENNUNG</b>	<b>TAFEL PAGE</b>	<b>NAME</b>
TISCHTEILE	1	TABLE PARTS
STEHENDER ARBEITSPLATZ	2	STANDING WORKING STATION
OBERTEILAUFHÄNGUNG	3	SEWING HEAD SUSPENSION
OBERTEIL - MONTAGE (JUKI)	4	SEWING HEAD (JUKI)
ANTRIEB - JUKI-OBERTEIL	5	DRIVE (JUKI-SEWING HEAD)
TRANSPORT	6	TRANSPORT
BANDTRANSPORT	7	STRIP TRANSPORT
ETIKETTENZUFÜHRUNG	8	LABEL FEEDING
SCHIEBETISCH	9	SLIDING TABLE
HUBTISCH	10	LIFTING TABLE
HUBTISCHABSENKUNG	11	LIFTING TABLE SINK

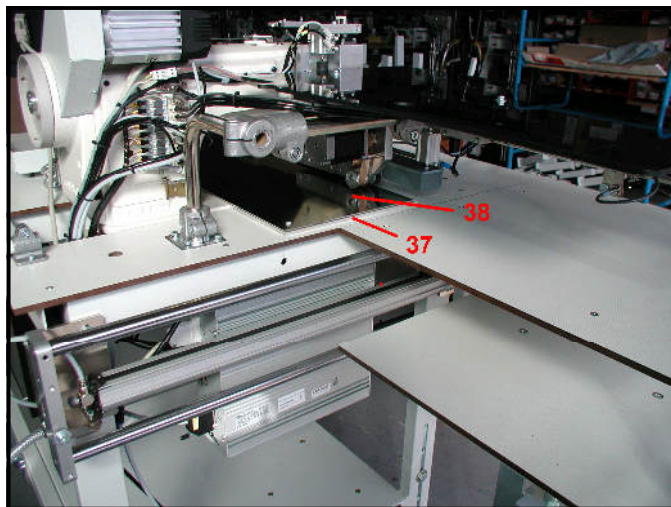
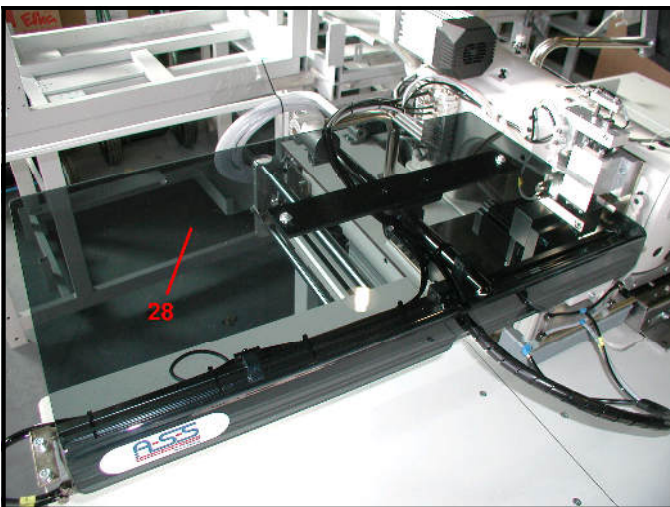
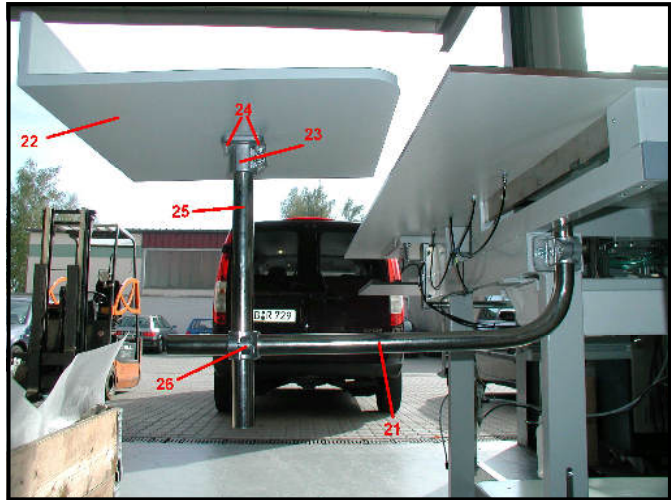
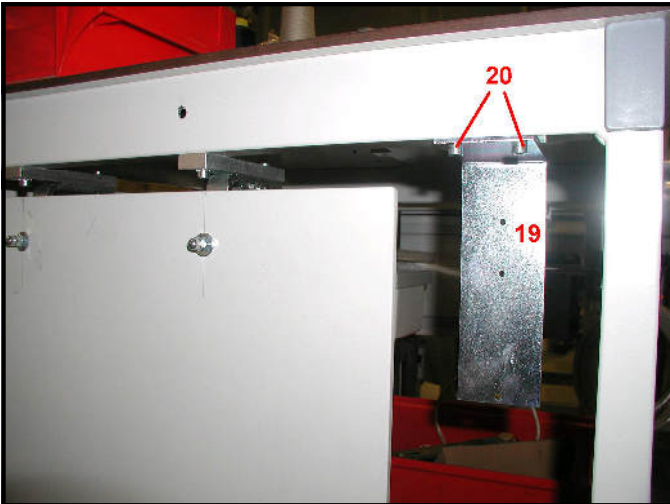
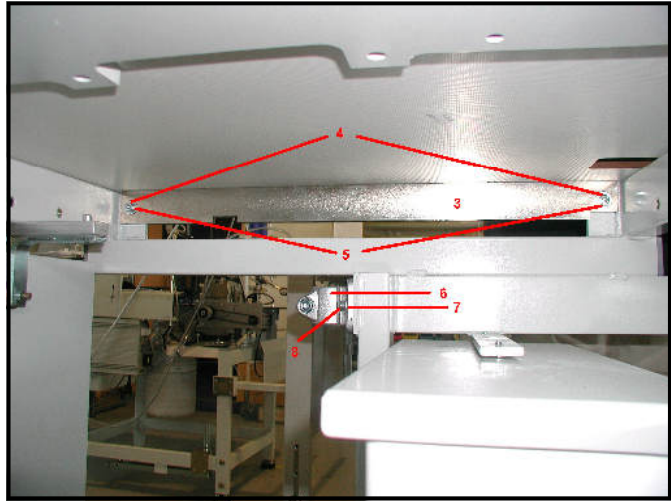
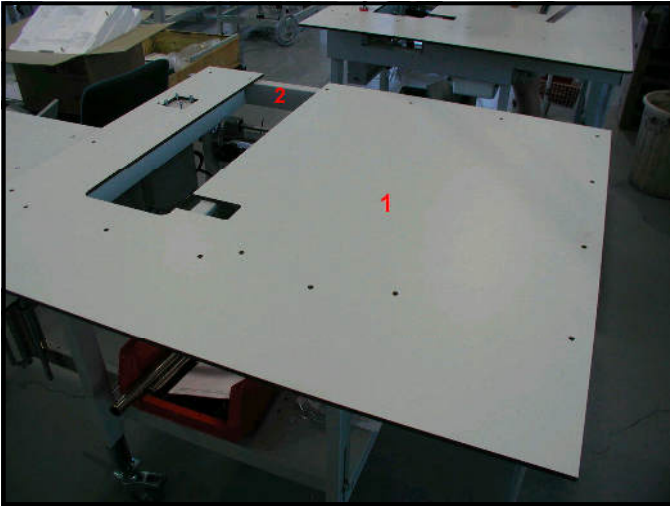

**BASS 5350**

**Tischteile**

**Tafel 1.0**

<b>NR. NO.</b>	<b>ARTIKEL NR. ARTICLE NO.</b>	<b>BEZEICHNUNG</b>	<b>NAME</b>	<b>ST. Q'ty</b>
1	030-2953-00	Tischplatte	table plate	1
2	030-2984-00	Tischgestell	table frame	1
3	030-2145-00	Leiste	moulding	1
4	DIN 912 M6x20	Zylinderschraube	screw	2
5	DIN 9021 A6,4	Scheibe	washer	2
6	050-16439-00	Klemme	clamp	1
7	DIN 9021 A6,4	Scheibe	washer	2
8	DIN 912 M6x16	Zylinderschraube	screw	2
9	030-0006-00	Luftdüse	air jet	4
10	030-0010-00	Mutter	nut	4
11	DIN 912 M4x30	Zylinderschraube	screw	2
12	030-0566-00	Lasche	cover plate	1
13	DIN 6797 A5,3	Zahnscheibe	washer	1
14	DIN 912 M5x25	Zylinderschraube	screw	1
15	030-3011-00	Bedienfeldhalter	control panel holder	1
16	DIN 912 M5x20	Zylinderschraube	screw	4
17	050-16434-00	Klemme	clamp	1
18	DIN 9021 A5,3	Scheibe	washer	4
19	030-0714-00	Halter	holder	1
20	DIN 912 M5x10	Zylinderschraube	screw	2
21	030-2146-00	Winkelrohr	pipe bend	1
22	030-2151-00	Ablage	tray	1
23	050-16435-00	Klemme	clamp	1
24	DIN 934 M6	Mutter	nut	4
25	030-1685-00	Rohr	pipe	1
26	050-16431-00	Klemme	clamp	1
27	DIN 7991 M6x35	Senkkopfschraube	screw	4
28	030-2155-00	Abdeckhaube	covering hood	1
29	030-2289-00	Ablage rechts	tray right	1
30	030-2947-00	Distanzhülse	distance bush	4
31	DIN 965 M4x25	Senkkopfschraube	screw	4
32	050-25873-00	Rohrkappe	sealing plug	2
33	045-12272-96	Filterregler	filter control	1
34	044-13254-00	Verschraubung	screw jet	1
35	050-16455-00	Gummi-Metall Puffer	gum puffer	4
36	044-14343-00	Verschraubung	screw jet	4
37	030-2944-00	Platte links	plate left	1
38	030-2946-00	Gleitplatte	sliding plate	1
39	030-2945-00	Platte rechts	plate right	1
40	030-2941-00	Führungsblech	guide tin	1

**BASS 5350**

**Tischteile**

**Tafel 1.0**

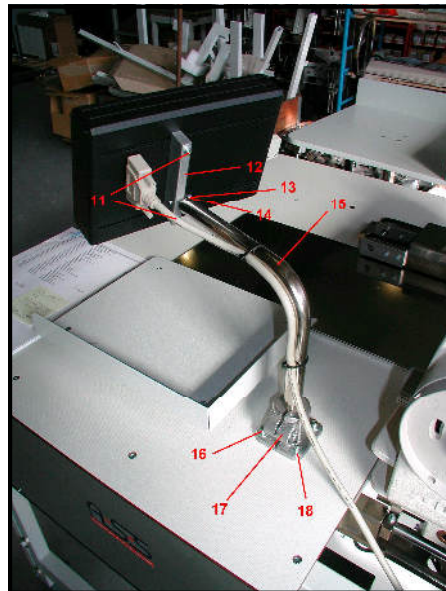
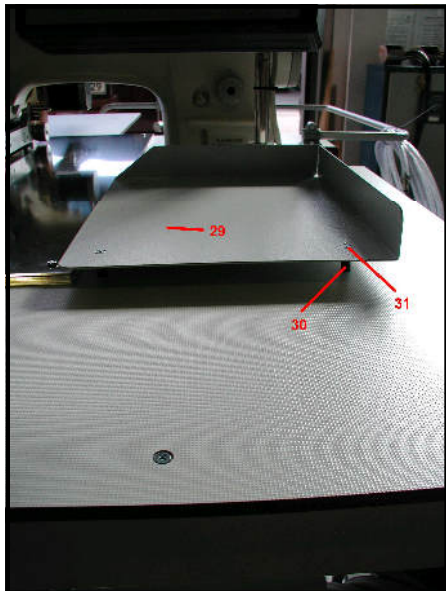
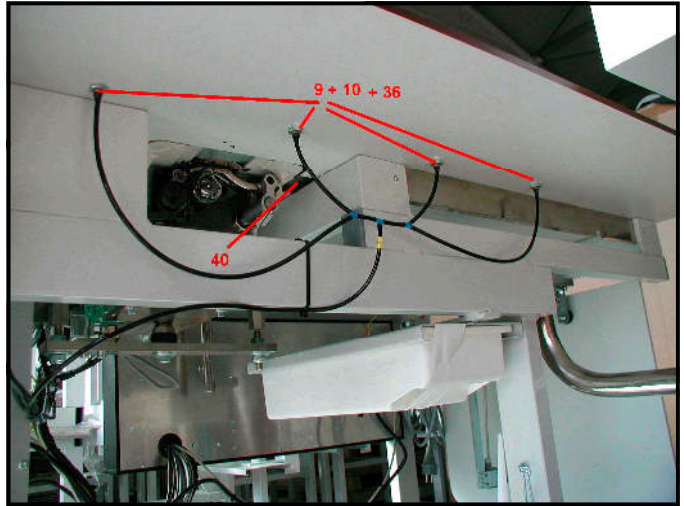

**BASS 5350**

**Tischteile**

**Tafel 1.1**

<b>NR. NO.</b>	<b>ARTIKEL NR. ARTICLE NO.</b>	<b>BEZEICHNUNG</b>	<b>NAME</b>	<b>ST. Q`ty</b>
1	030-2953-00	Tischplatte	table plate	1
2	030-2984-00	Tischgestell	table frame	1
3	030-2145-00	Leiste	moulding	1
4	DIN 912 M6x20	Zylinderschraube	screw	2
5	DIN 9021 A6,4	Scheibe	washer	2
6	050-16439-00	Klemme	clamp	1
7	DIN 9021 A6,4	Scheibe	washer	2
8	DIN 912 M6x16	Zylinderschraube	screw	2
9	030-0006-00	Luftdüse	air jet	4
10	030-0010-00	Mutter	nut	4
11	DIN 912 M4x30	Zylinderschraube	screw	2
12	030-0566-00	Lasche	cover plate	1
13	DIN 6797 A5,3	Zahnscheibe	washer	1
14	DIN 912 M5x25	Zylinderschraube	screw	1
15	030-3011-00	Bedienfeldhalter	control panel holder	1
16	DIN 912 M5x20	Zylinderschraube	screw	4
17	050-16434-00	Klemme	clamp	1
18	DIN 9021 A5,3	Scheibe	washer	4
19	030-0714-00	Halter	holder	1
20	DIN 912 M5x10	Zylinderschraube	screw	2
21	030-2146-00	Winkelrohr	pipe bend	1
22	030-2151-00	Ablage	tray	1
23	050-16435-00	Klemme	clamp	1
24	DIN 934 M6	Mutter	nut	4
25	030-1685-00	Rohr	pipe	1
26	050-16431-00	Klemme	clamp	1
27	DIN 7991 M6x35	Senkkopfschraube	screw	4
28	030-2155-00	Abdeckhaube	covering hood	1
29	030-2289-00	Ablage rechts	tray right	1
30	030-2947-00	Distanzhülse	distance bush	4
31	DIN 965 M4x25	Senkkopfschraube	screw	4
32	050-25873-00	Rohrkappe	sealing plug	2
33	045-12272-96	Filterregler	filter control	1
34	044-13254-00	Verschraubung	screw jet	1
35	050-16455-00	Gummi-Metall Puffer	gum puffer	4
36	044-14343-00	Verschraubung	screw jet	4
37	030-2944-00	Platte links	plate left	1
38	030-2946-00	Gleitplatte	sliding plate	1
39	030-2945-00	Platte rechts	plate right	1
40	030-2941-00	Führungsblech	guide tin	1
<b>BASS 5350</b>		<b>Tischteile</b>		<b>Tafel 1.1</b>

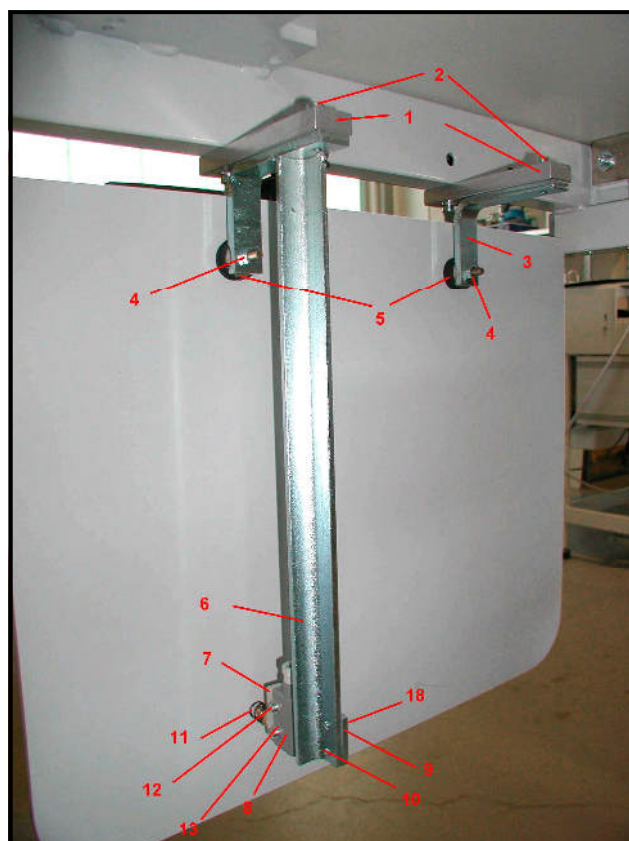
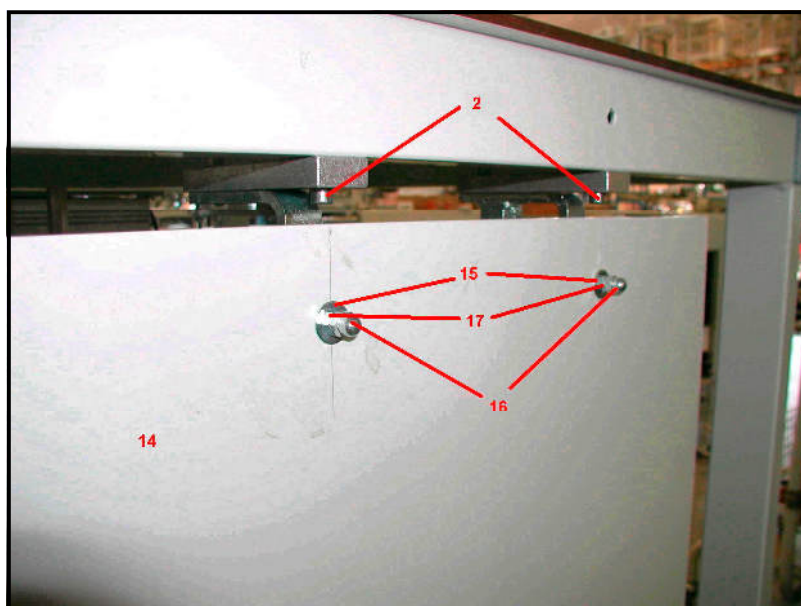

**BASS 5350**

**Stehender Arbeitsplatz**

**Tafel 2.0**



<b>NR. NO.</b>	<b>ARTIKEL NR. ARTICLE NO.</b>	<b>BEZEICHNUNG</b>	<b>NAME</b>	<b>ST. Q`ty</b>
1	030-2942-00	Lasche	bracket	2
2	DIN 912 M6x20	Zylinderschraube	screw	4
3	030-0917-00	Winkel	angle	1
4	DIN 934 M6	Mutter	nut	2
5	050-16481-00	Gummi-Puffer	rubber buffer	2
6	030-0918-00	Winkel	angle	1
7	060-20556-00	Mikroschalter	switch	1
8	060-20563-00	Abdeckkappe	cover cap	1
9	030-0916-00	Lasche	bracket	1
10	DIN 912 M4x10	Zylinderschraube	screw	2
11	050-17446-00	Druckfeder	pressure spring	1
12	DIN 912 M3x20	Zylinderschraube	screw	2
13	DIN 9021 A3,2	Scheibe	washer	2
14	030-0915-00	Sperrholzplatte	plate	1
15	DIN 9021 A6,4	Scheibe	washer	2
16	DIN 1587 M6	Mutter	nut	2
17	DIN 934 M6	Mutter	nut	2
18	DIN 9021 A4,2	Scheibe	washer	2
<b>BASS 5350</b>		<b>Stehender Arbeitsplatz</b>		<b>Tafel 2.0</b>

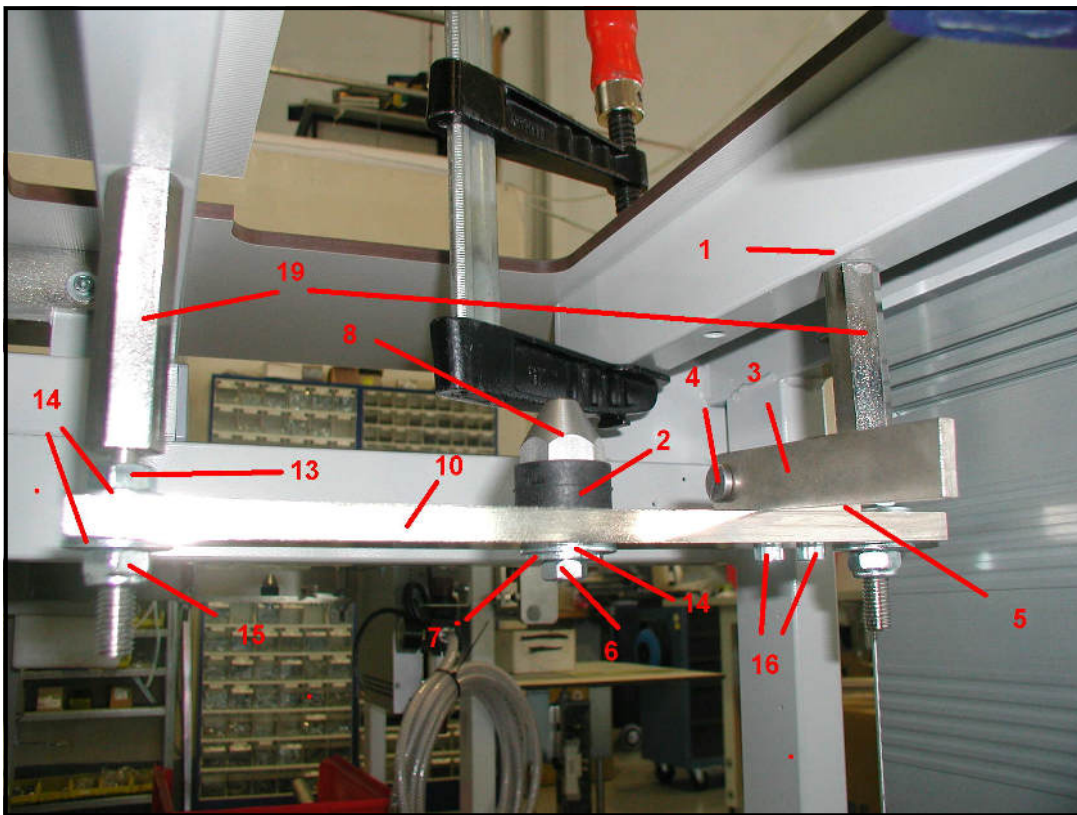
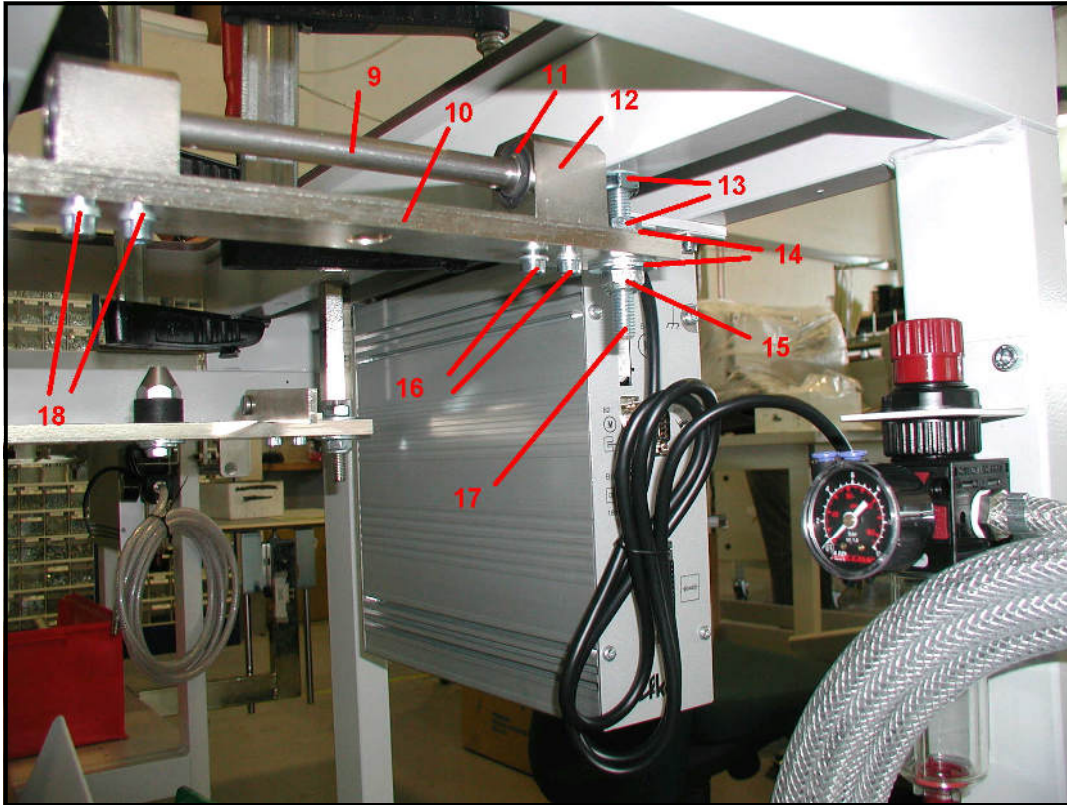

**BASS 5350**

**Oberteilaufhängung**

**Tafel 3.0**

<b>NR. NO.</b>	<b>ARTIKEL NR. ARTICLE NO.</b>	<b>BEZEICHNUNG</b>	<b>NAME</b>	<b>ST. Q'ty</b>
1	DIN 913 M10x60	Gewindestift	set screw	2
2	050-16502-00	Gummipuffer	rubber buffer	1
3	030-2013-00	Stütze	brace	1
4	DIN 923 M6x6	Bundschraube	screw	1
5	030-2015-00	Winkel	angle	1
6	DIN 934 M8	Mutter	nut	1
7	DIN 9021 A8,4	Scheibe	washer	1
8	030-2014-00	Bolzen	bolt	1
9	030-2012-00	Welle	shaft	1
10	030-2010-00	Träger	porter	2
11	050-16499-00	Buchse	bush	2
12	030-2011-00	Lagerbock	bearing block	2
13	DIN 934 M10	Mutter	nut	6
14	DIN 9021 A10,5	Scheibe	washer	8
15	DIN 985 M8	Mutter	nut	4
16	DIN 912 M6x16	Zylinderschraube	screw	4
17	DIN 913 M10x100	Gewindestift	set screw	2
18	DIN 125 A6,4	Scheibe	washer	4
19	030-2133-00	Stehbolzen	stay bolt	2
<b>BASS 5350</b>		<b>Oberteilaufhängung</b>		<b>Tafel 3.0</b>

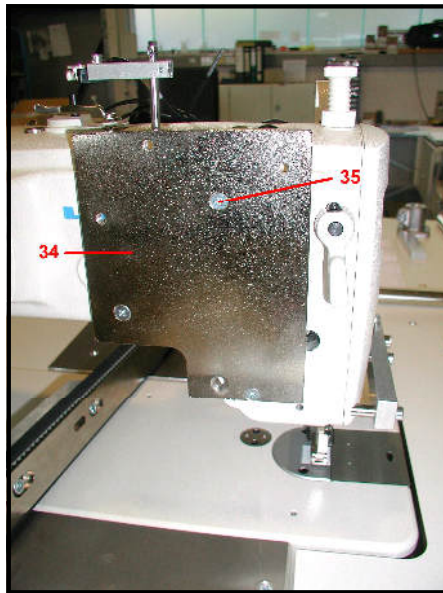
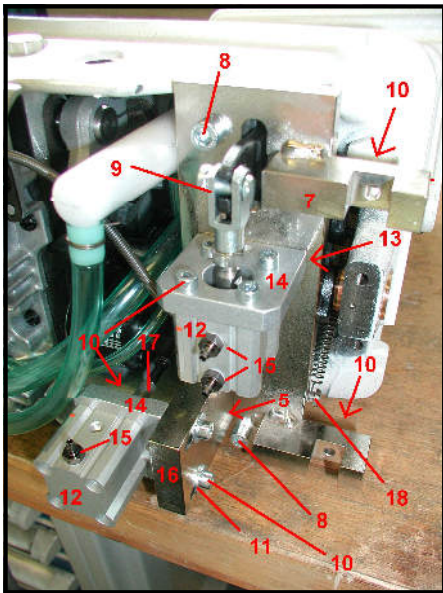
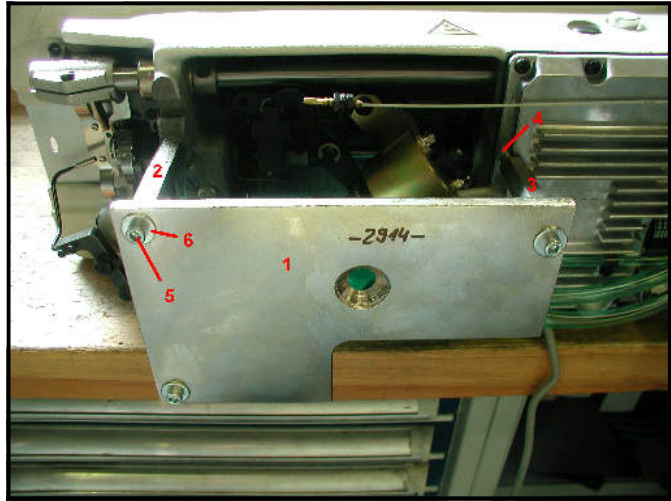
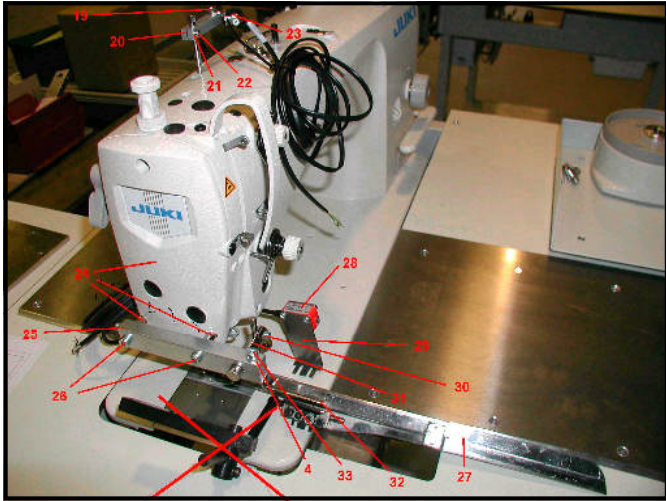

**BASS 5350**

**Oberteil - Montage (Juki)**

**Tafel 4.0**

<b>NR. NO.</b>	<b>ARTIKEL NR. ARTICLE NO.</b>	<b>BEZEICHNUNG</b>	<b>NAME</b>	<b>ST. Q`ty</b>
1	030-2914-00	Platte	plate	1
2	030-2660-00	Stehbolzen	stay bolt	2
3	030-2917-00	Stehbolzen	stay bolt	1
4	DIN 125 A5,3	Scheibe	washer	1
5	DIN 912 M5x16	Zylinderschraube	screw	3
6	DIN 9021 A6,4	Scheibe	washer	3
7	030-2915-00	Lagerbock	baering block	1
8	DIN 912 M6x20	Zylinderschraube	screw	2
9	050-10099-00	F-Befestigung	attachment	1
10	DIN 912 M4x20	Zylinderschraube	screw	10
11	DIN 9021 A4,2	Scheibe	washer	2
12	041-16010-19	Zylinder	cylinder	2
13	DIN 912 M4x16	Zylinderschraube	screw	2
14	030-2926-00	Platte	plate	2
15	044-14343-00	Verschraubung	screw joint	3
16	030-2924-00	Distanzstück	distance piece	1
17	030-2925-00	Stempel	stamp	1
18	DIN 923 M4x3	Bundschraube	screw	1
19	DIN 912 M3x6	Zylinderschraube	screw	1
20	030-2921-00	Klemme	clamp	1
21	DIN 125 A3,2	Scheibe	washer	1
22	DIN 912 M3x10	Zylinderschraube	screw	1
23	060-21754-00	Oberfadenwächter	sensor	1
24	030-3009-00	Kopfdeckel-Juki	head cover (Juki)	1
25	030-2949-00	Klemme	clamp	1
26	DIN 912 M5x40	Zylinderschraube	screw	2
27	050-16655-00	Apparat	folder	1
28	060-21743-04	Fotozelle	photocell	1
29	030-2951-00	Fotozellenhalter	photocell holder	1
30	DIN 912 M4x10	Zylinderschraube	screw	1
31	030-2948-00	Klemmbolzen	clamp bolt	1
32	030-2950-00	Winkel	angle	1
33	DIN 912 M5x20	Zylinderschraube	screw	1
34	030-2940-00	Adapterplatte	adapter plate	1
35	DIN 963 M4x16	Senkschraube	screw	3
36	030-2927-00-N	Deckel-Oberteil (JUKI)	cover (Juki)	1
<b>BASS 5350</b>		<b>Oberteil - Montage (Juki)</b>		<b>Tafel 4.0</b>

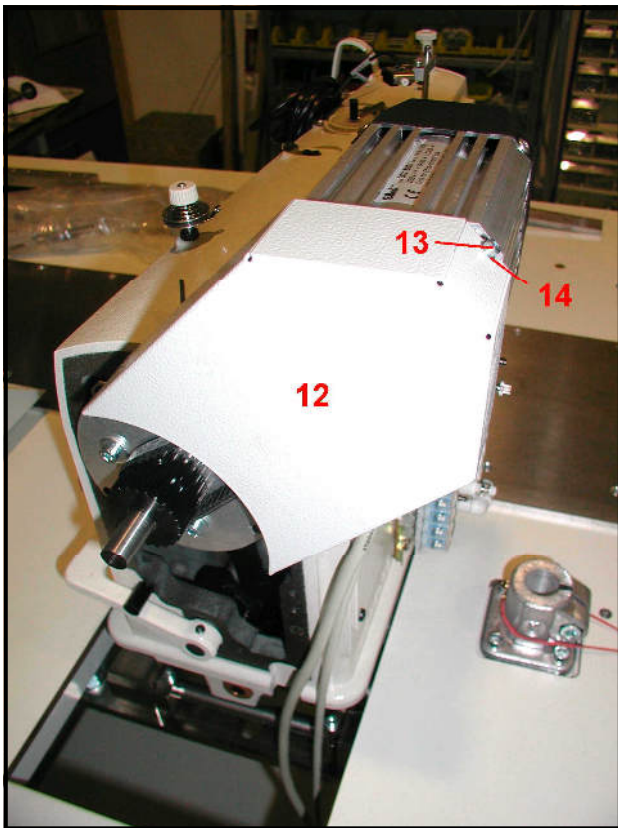
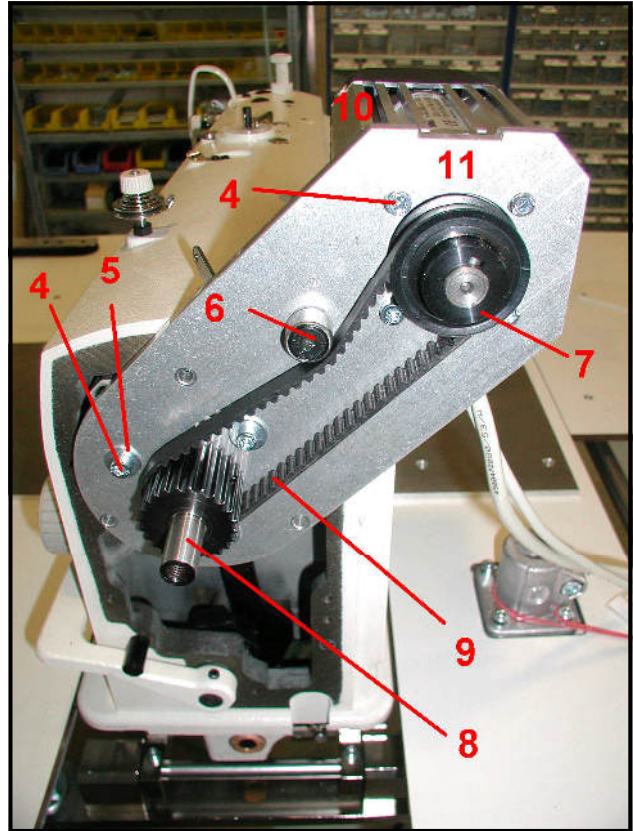
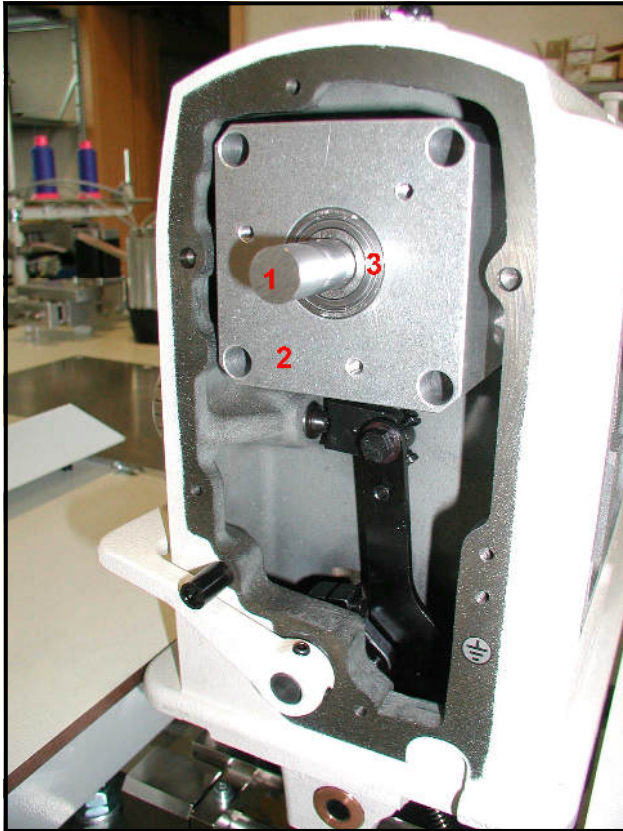

**BASS 5350**

**Antrieb - Juki-Oberteil**

**Tafel 5.0**

<b>NR. NO.</b>	<b>ARTIKEL NR. ARTICLE NO.</b>	<b>BEZEICHNUNG</b>	<b>NAME</b>	<b>ST. Q'ty</b>
1	030-2920-00	Welle	shaft	1
2	030-2913-00	Führungsstück	guide piece	1
3	050-15381-10	Rillenkugellager	ball bearing	2
4	DIN 912 M5x20	Zylinderschraube	screw	7
5	DIN 9021 A5,3	Scheibe	washer	3
6	050-15366-00	Kurvenrolle	cam roller	1
7	030-2317-00	Zahnscheibe	toothed washer	1
8	030-2663-00	Zahnscheibe	toothed washer	1
9	050-25925-52	Zahnriemen	toothed belt	1
10	060-24826-51	Antrieb DC 1500	drive DC 1500	1
11	030-2662-00	Motorplatte	engine plate	1
12	030-2665-00	Schutz	cover	1
13	DIN 912 M3x8	Zylinderschraube	screw	3
14	DIN 125 A3,2	Scheibe	washer	3
<b>BASS 5350</b>		<b>Antrieb - Juki-Oberteil</b>		<b>Tafel 5.0</b>

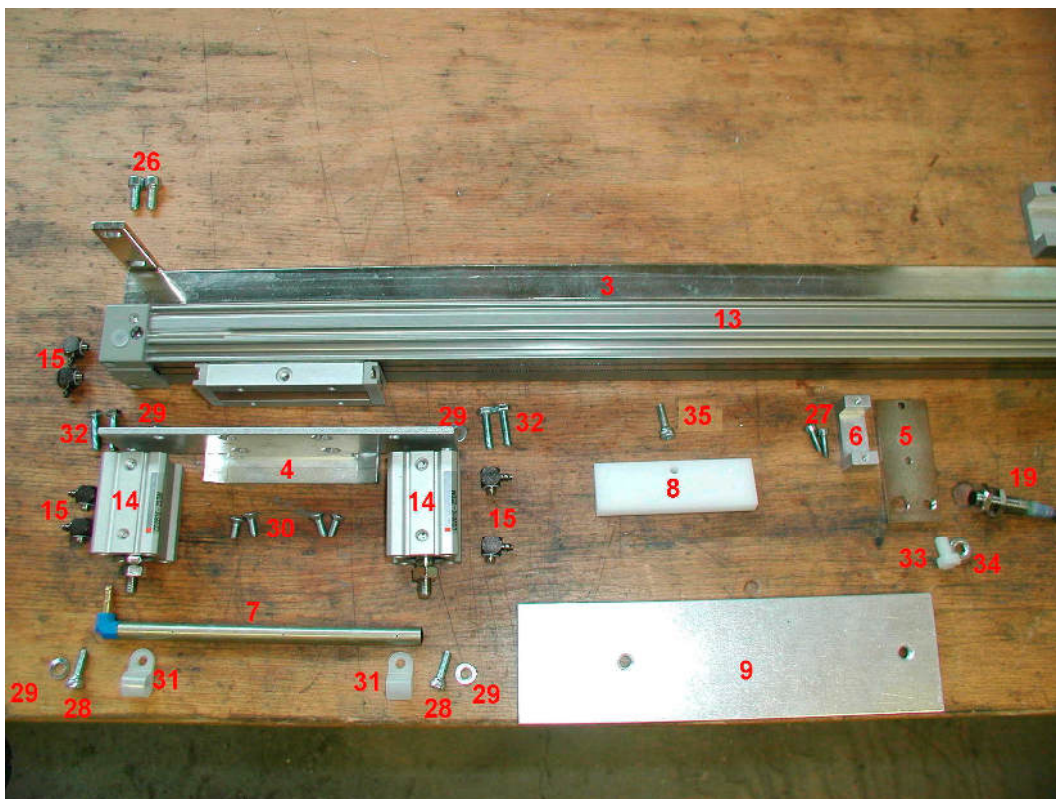
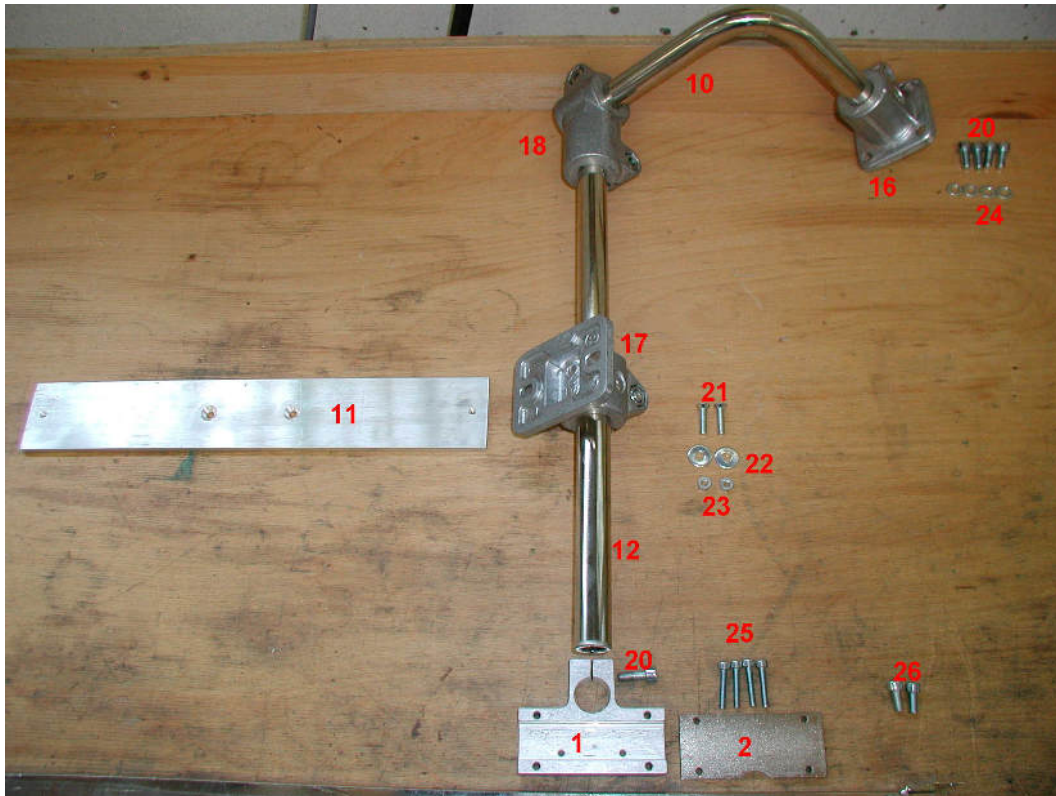

**BASS 5350**

**Transport**

**Tafel 6.0**



<b>NR. NO.</b>	<b>ARTIKEL NR. ARTICLE NO.</b>	<b>BEZEICHNUNG</b>	<b>NAME</b>	<b>ST. Q'ty</b>
1	030-0720-00	Klemme	clamp	1
2	030-0721-00	Platte	plate	1
3	030-2180-00	Zylinderhalter	cylinder holder	1
4	030-2181-00	Halter	holder	1
5	030-2184-00	Platte	plate	1
6	030-2186-00	Klemme	clamp	1
7	030-2187-00	Blasrohr	blow pipe	1
8	030-2894-00	Führungsstück	guide piece	1
9	030-2937-00	Platte	plate	1
10	030-2943-00	Winkelrohr	angle pipe	1
11	030-2952-00	Halteplatte	holding plate	1
12	030-2965-00	Rohr	pipe	1
13	040-10236-01	Zylinder	cylinder	1
14	041-16025-20	Zylinder	cylinder	2
15	044-14341-00	Verschraubung	screw joint	6
16	050-16434-00	Klemme	clamp	1
17	050-16438-00	Klemme	clamp	1
18	050-16440-00	Klemme	clamp	1
19	060-21724-00	Schalter	switch	1
20	DIN 912 M6X16	Zylinderschraube	screw	5
21	DIN 965 M5X20	Senkschraube	screw	2
22	DIN 9021 A 5,3	Scheibe	washer	2
23	DIN 934 M5	Sechskantmutter	nut	2
24	DIN 125 A 6,4	Scheibe	washer	4
25	DIN 912 M4X22	Zylinderschraube	screw	4
26	DIN 912 M5X12	Zylinderschraube	screw	4
27	DIN 912 M3X10	Zylinderschraube	screw	2
28	DIN 912 M4X12	Zylinderschraube	screw	2
29	DIN 125 A 4,2	Scheibe	washer	6
30	DIN 965 M4X10	Senkschraube	screw	4
31	HNY 4	Klemme	clamp	2
32	DIN 933 M4X16	Sechskantschraube	screw	4
33	DIN 933 M6X16	Schraube-Kunststoff	screw	1
34	DIN 439 M6	Sechskantmutter	nut	1
35	DIN 912 M4X16	Zylinderschraube	screw	1
<b>BASS 5350</b>		<b>Transport</b>		<b>Tafel 6.0</b>

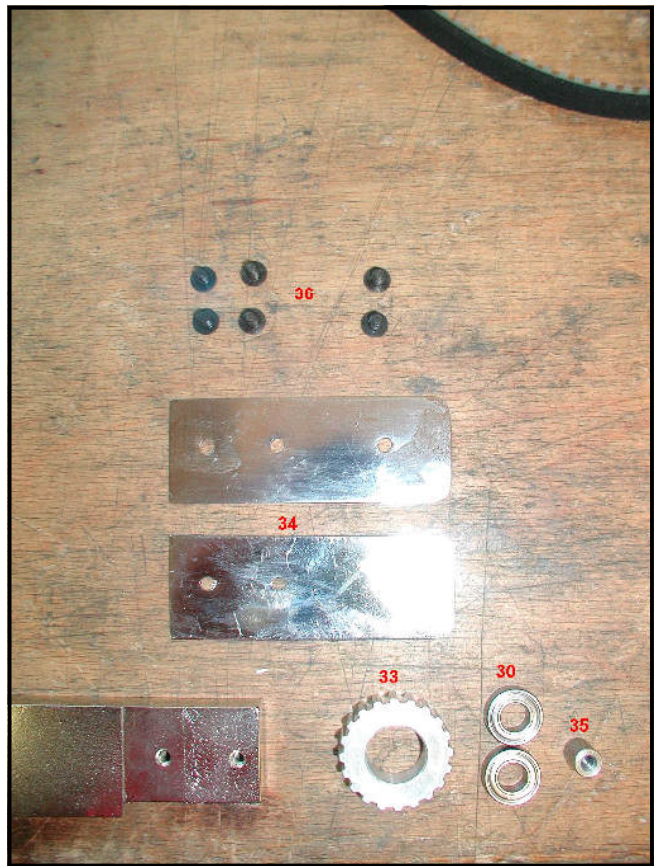
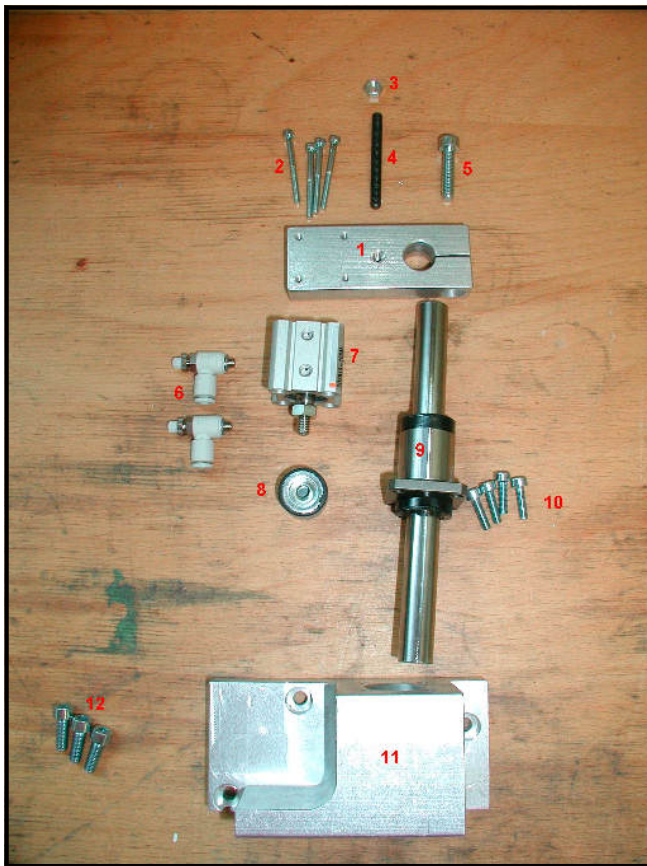
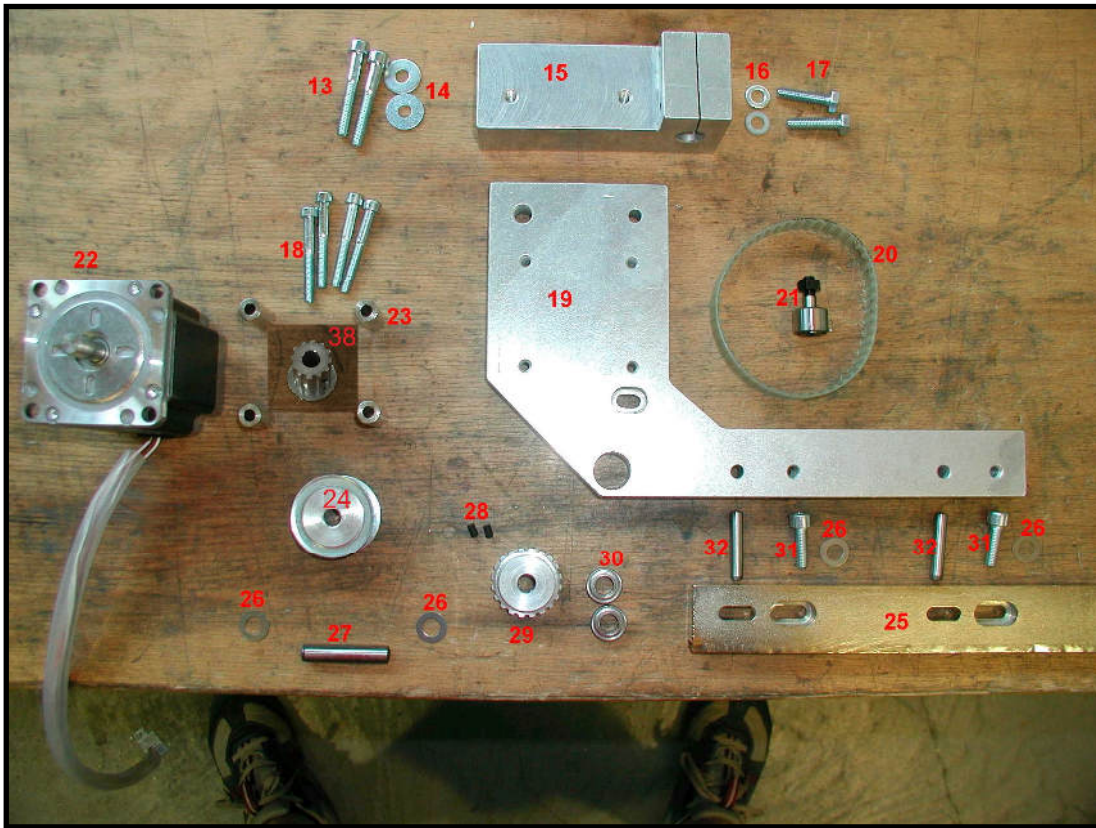

**BASS 5350**

**Bandtransport**

**Tafel 7.0**

<b>NR. NO.</b>	<b>ARTIKEL NR. ARTICLE NO.</b>	<b>BEZEICHNUNG</b>	<b>NAME</b>	<b>ST. Q`ty</b>
1	030-2935-00	Distanzstück	distance piece	1
2	DIN 912 M3x35	Zylinderschraube	screw	4
3	DIN 934 M5	Mutter	nut	1
4	DIN 913 M5x50	Gewindestift	set screw	1
5	DIN 912 M6x25	Zylinderschraube	screw	1
6	042-06927-00	Drossel	throttle	2
7	041-16010-19	Zylinder	cylinder	1
8	050-16474-00	Gummipuffer	rubber buffer	1
9	030-1731-01	Welle mit Kugelbuchse	shaft with ball bush	1
10	DIN 912 M4x14	Zylinderschraube	screw	4
11	030-2936-00	Klotz	block	1
12	DIN 912 M5x14	Zylinderschraube	screw	3
13	DIN 912 M6x40	Zylinderschraube	screw	2
14	DIN 9021 A6,4	Scheibe	washer	2
15	030-2933-00	Klemme	clamp	1
16	DIN 125 A6,4	Scheibe	washer	2
17	DIN 933 M6x25	Sechskantschraube	screw	2
18	DIN 912 M5x40	Zylinderschraube	screw	4
19	030-2932-00	Halteplatte	holding plate	1
20	050-25802-00	Zahnriemen	toothed belt	1
21	050-15366-00	Kurvenrolle	cam roller	1
22	060-21227-03	Schrittmotor	stepping motor	1
23	050-21755-05	Distanzhülse	distance bush	4
24	030-2938-00	Synchrone Scheibe	pulley	1
25	030-2931-00	Führungsschiene	guide rail	1
26	DIN 988 - 8x14x0,5	Paßscheibe	washer	4
27	DIN 6325 - 8x60	Paßstift	dowel pin	1
28	DIN 913 M4x8	Gewindestift	set screw	2
29	030-2939-00	Synchrone Scheibe	pulley	1
30	050-15377-00	Kugellager	ball bearing	4
31	DIN 912 M6x20	Zylinderschraube	screw	2
32	DIN 6325 - 6x25	Paßstift	dowel pin	2
33	030-2930-00	Synchrone Scheibe	pulley	1
34	030-2929-00	Führungsblech	guide tin	2
35	030-2928-00	Bolzen	bolt	1
36	050-27191-80	Schraube	screw	6
37	050-25918-10	Zahnriemen	toothed belt	1
38	030-2373-00	Synchrone Scheibe	pulley	1
<b>BASS 5350</b>		<b>Bandtransport</b>		<b>Tafel 7.0</b>

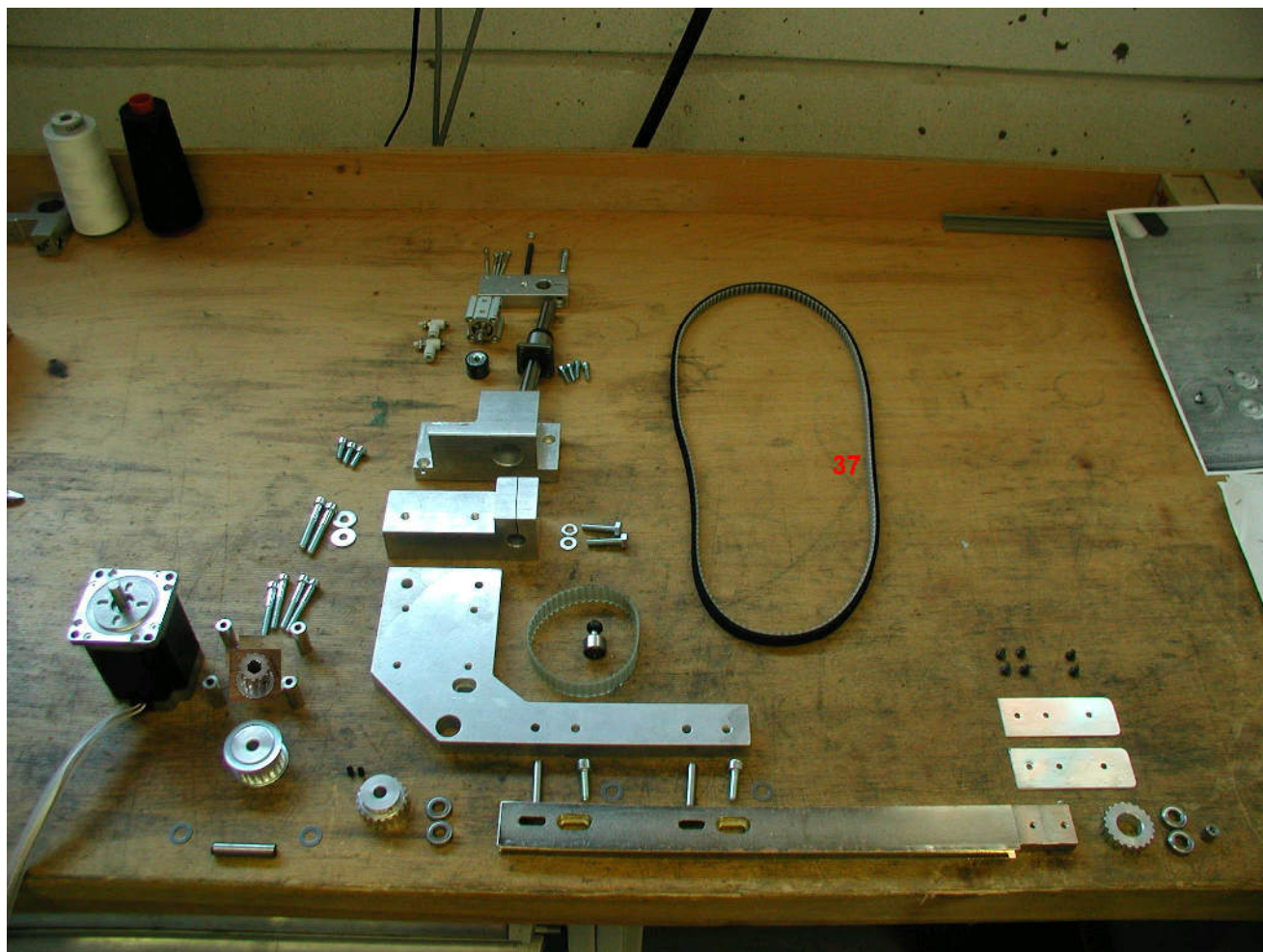

**BASS 5350**

**Bandtransport**

**Tafel 7.0**

<b>NR. NO.</b>	<b>ARTIKEL NR. ARTICLE NO.</b>	<b>BEZEICHNUNG</b>	<b>NAME</b>	<b>ST. Q`ty</b>
1	030-2935-00	Distanzstück	distance piece	1
2	DIN 912 M3x35	Zylinderschraube	screw	4
3	DIN 934 M5	Mutter	nut	1
4	DIN 913 M5x50	Gewindestift	set screw	1
5	DIN 912 M6x25	Zylinderschraube	screw	1
6	042-06927-00	Drossel	throttle	2
7	041-16010-19	Zylinder	cylinder	1
8	050-16474-00	Gummipuffer	rubber buffer	1
9	030-1731-01	Welle mit Kugelbuchse	shaft with ball bush	1
10	DIN 912 M4x14	Zylinderschraube	screw	4
11	030-2936-00	Klotz	block	1
12	DIN 912 M5x14	Zylinderschraube	screw	3
13	DIN 912 M6x40	Zylinderschraube	screw	2
14	DIN 9021 A6,4	Scheibe	washer	2
15	030-2933-00	Klemme	clamp	1
16	DIN 125 A6,4	Scheibe	washer	2
17	DIN 933 M6x25	Sechskantschraube	screw	2
18	DIN 912 M5x40	Zylinderschraube	screw	4
19	030-2932-00	Halteplatte	holding plate	1
20	050-25802-00	Zahnriemen	toothed belt	1
21	050-15366-00	Kurvenrolle	cam roller	1
22	060-21227-03	Schrittmotor	stepping motor	1
23	050-21755-05	Distanzhülse	distance bush	4
24	030-2938-00	Synchrone Scheibe	pulley	1
25	030-2931-00	Führungsschiene	guide rail	1
26	DIN 988 - 8x14x0,5	Paßscheibe	washer	4
27	DIN 6325 - 8x60	Paßstift	dowel pin	1
28	DIN 913 M4x8	Gewindestift	set screw	2
29	030-2939-00	Synchrone Scheibe	pulley	1
30	050-15377-00	Kugellager	ball bearing	4
31	DIN 912 M6x20	Zylinderschraube	screw	2
32	DIN 6325 - 6x25	Paßstift	dowel pin	2
33	030-2930-00	Synchrone Scheibe	pulley	1
34	030-2929-00	Führungsblech	guide tin	2
35	030-2928-00	Bolzen	bolt	1
36	050-27191-80	Schraube	screw	6
37	050-25918-10	Zahnriemen	toothed belt	1
38	030-2373-00	Synchrone Scheibe	pulley	1
<b>BASS 5350</b>		<b>Bandtransport</b>		<b>Tafel 7.0</b>

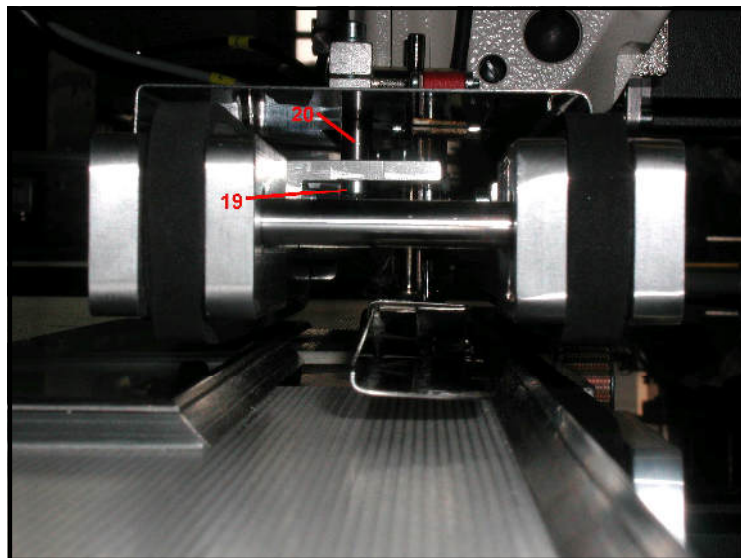
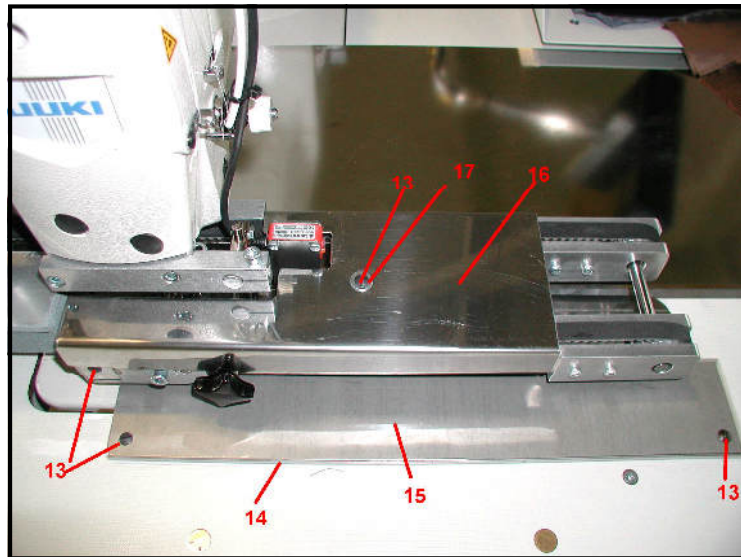
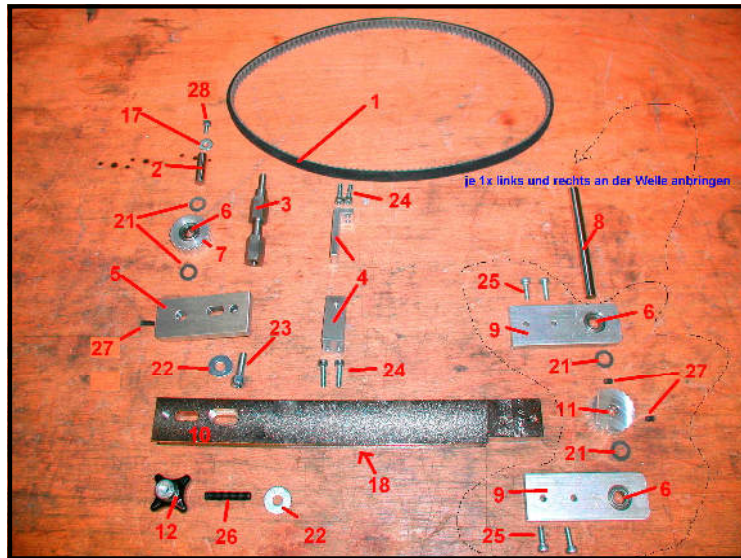

**BASS 5350**

**Etikettenzuführung**

**Tafel 8.0**

<b>NR. NO.</b>	<b>ARTIKEL NR. ARTICLE NO.</b>	<b>BEZEICHNUNG</b>	<b>NAME</b>	<b>ST. Q'ty</b>
1	050-25926-10	Zahnriemen	toothed belt	1
2	030-2999-00	Lagerbolzen	bearing bolt	1
3	030-3001-00	Distanzbolzen	distance bolt	1
4	030-3000-00	Winkel	angle	2
5	030-3002-00	Riemenspannplatte	belt fixing plate	1
6	050-15377-00	Kugellager	ball bearing	4
7	030-2930-00	Synchrone Scheibe	toothed washer	1
8	030-0132-00	Welle	shaft	1
9	030-3004-00	Führungsblech	guide tin	4
10	030-2998-00	Führungsschiene	guide rail	1
11	030-3003-00	Synchrone Scheibe	toothed washer	2
12	050-16503-00	Kreuzgriff	handle	1
13	050-27191-80	Schraube	screw	6
14	030-3005-00	Auflage	support	1
15	030-3006-00	Abdeckplatte	cover plate	1
16	030-3007-00	Abdeckung	cover	1
17	DIN 9021 A4,2	Scheibe	washer	1
18	030-3013-00	Gleitstreifen	striation	1
19	DIN 912 M4x10	Schraube	screw	1
20	030-2928-00	Bolzen	bolt	1
21	DIN 988 - 8x14x0,3	Paßscheibe	washer	6
22	DIN 9021 A6,4	Scheibe	washer	2
23	DIN 912 M6x16	Zylinderschraube	screw	1
24	DIN 912 M4x14	Zylinderschraube	screw	4
25	DIN 912 M4x12	Zylinderschraube	screw	8
26	DIN 913 M6x35	Gewindestift	set screw	1
27	DIN 913 M4x10	Gewindestift	set screw	5
28	DIN 912 M4x6	Zylinderschraube	screw	1
<b>BASS 5350</b>		<b>Etikettenzuführung</b>		<b>Tafel 8.0</b>

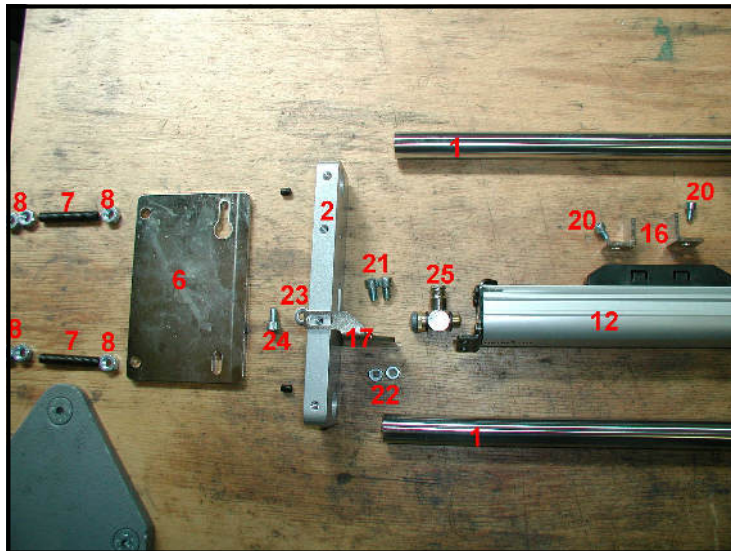
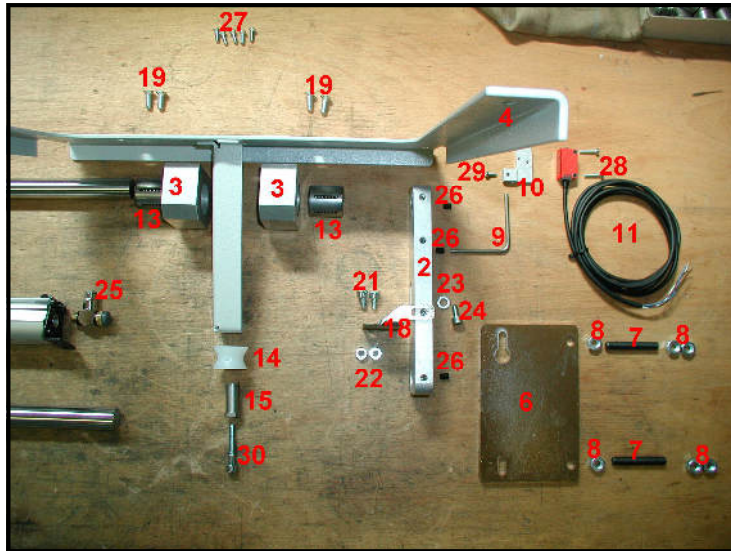

**BASS 5350**

**Schiebetisch**

**Tafel 9.0**



<b>NR. NO.</b>	<b>ARTIKEL NR. ARTICLE NO.</b>	<b>BEZEICHNUNG</b>	<b>NAME</b>	<b>ST. Q'ty</b>
1	030-2208-00	Welle	shaft	2
2	030-2209-00	Lasche	ledge	2
3	030-2210-00	Lagerbock	bearing bracket	2
4	030-2211-00	Wagen	carriage	1
5	030-2212-00	Platte	plate	1
6	030-2213-00	Halteplatte	holding plate	2
7	DIN 913 M8x55	Gewindestift	grub screw	4
8	DIN 934 M8	Mutter	nut	12
9	030-0942-00	Fotozellenhalter	photocell holder	1
10	030-0036-00	Fotozellenhalter	photocell holder	1
11	060-21724-00	Fotozelle	photocell	1
12	040-10236-02	Bandzylinder	cylinder	1
13	050-15522-00	Kugellager	ball bearing	2
14	030-2214-00	Stützrolle	support roller	1
15	030-2215-00	Excenterbolzen	eccentric bolt	1
16	030-2216-00	Winkel	square	2
17	030-2217-00	Winkel	square	1
18	030-2218-00	Winkel	square	1
19	DIN 7991 M6x16	Senkschraube	screw	4
20	DIN 912 M5x8	Zylinderschraube	screw	2
21	DIN 912 M6x10	Zylinderschraube	screw	4
22	DIN 934 M6	Mutter	nut	4
23	DIN 125 A6,4	Scheibe	washer	2
24	DIN 912 M6x12	Zylinderschraube	screw	2
25	044-14384-00	Verschraubung	screw joint	2
26	DIN 913 M6x8	Gewindestift	grub screw	5
27	DIN 7991 M4x12	Senkschraube	screw	5
28	DIN 912 M3x16	Zylinderschraube	screw	2
29	DIN 912 M3x8	Zylinderschraube	screw	1
30	DIN 912 M6x35	Zylinderschraube	screw	1
<b>BASS 5350</b>		<b>Schiebetisch</b>		<b>Tafel 9.0</b>

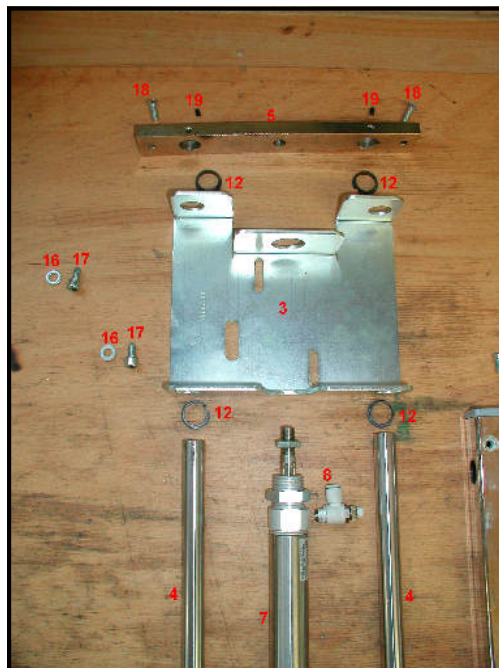
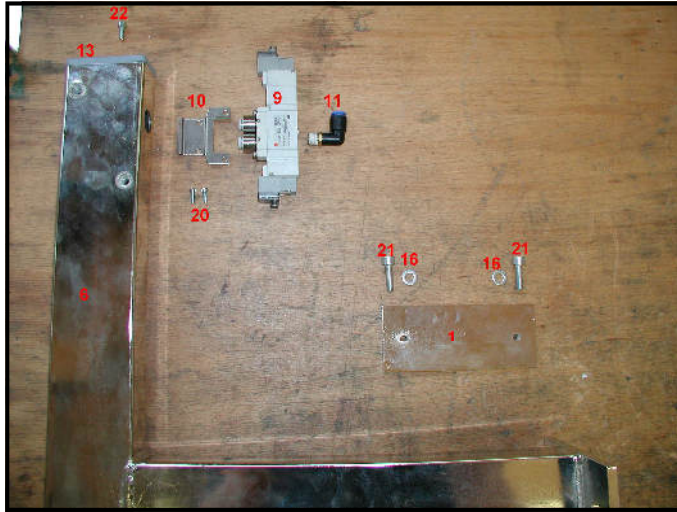

**BASS 5350**

**Hubtisch**

**Tafel 10.0**

<b>NR. NO.</b>	<b>ARTIKEL NR. ARTICLE NO.</b>	<b>BEZEICHNUNG</b>	<b>NAME</b>	<b>ST. Q'ty</b>
1	030-2196-00	Platte	plate	1
2	030-2200-00	Hubtischplatte	plate	1
3	030-2871-00	Halter	holder	1
4	030-2886-00	Welle	shaft	2
5	030-2887-00	Brücke	bridge	1
6	030-2888-00	Halter	holder	1
7	040-25250-21	Zylinder	cylinder	1
8	042-11197-00	Drosselhohlschraube	throttle valve	2
9	042-11278-00	Ventil	valve	1
10	042-11279-00	Halterung für Ventil	holder to valve	1
11	044-13287-00	Einschraubwinkel	screw joint	1
12	050-15422-00	Clips-Lager	clip bearing	4
13	050-25873-00	Kunststoff-Kappe	pipe cap	1
14	030-2152-00	Bügel	stirrup	1
15	050-16447-00	Klemme	clamp	1
16	DIN 125 A6,4	Scheibe	washer	4
17	DIN 912 M6x12	Zylinderschraube	screw	2
18	DIN 965 M6x16	Senkschraube	screw	2
19	DIN 913 M4x8	Gewindestift	set screw	2
20	DIN 912 M3x8	Zylinderschraube	screw	2
21	DIN 912 M6x18	Zylinderschraube	screw	2
22	DIN 912 M4x8	Zylinderschraube	screw	1
<b>BASS 5350</b>		<b>Hubtisch</b>		<b>Tafel 10.0</b>

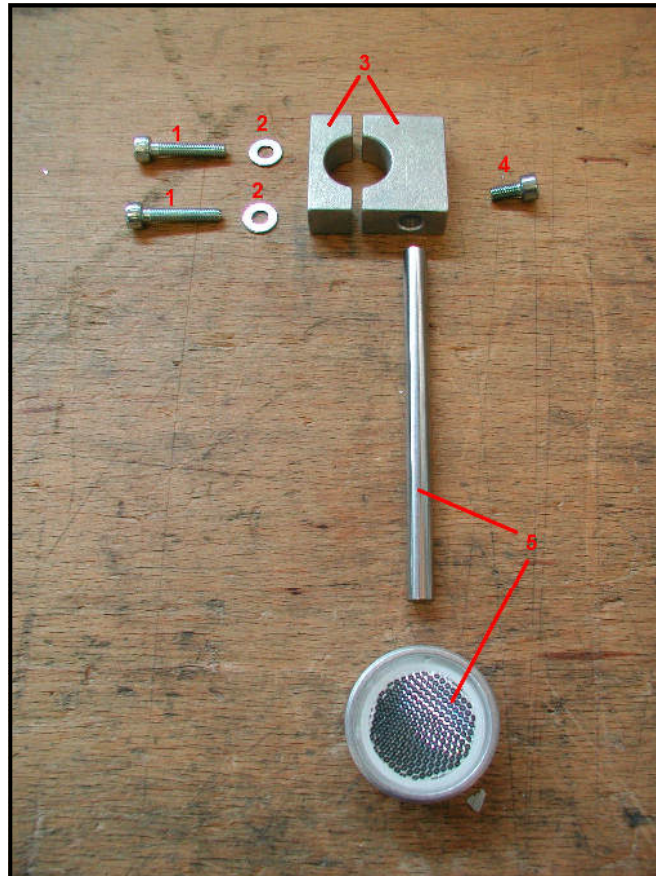

**BASS 5350**

**Hubtischabsenkung**

**Tafel 11.0**

<b>NR. NO.</b>	<b>ARTIKEL NR. ARTICLE NO.</b>	<b>BEZEICHNUNG</b>	<b>NAME</b>	<b>ST. Q'ty</b>
1	DIN 912 M4x20	Zylinderschraube	screw	2
2	DIN 125 A4,2	Scheibe	washer	2
3	030-2206-00	Halter	holder	1
4	DIN 912 M4x8	Zylinderschraube	screw	1
5	030-2207-00	Reflektor	reflector	1
<b>BASS 5350</b>		<b>Hubtischabsenkung</b>		<b>Tafel 11.0</b>