



TEILELISTE

Part list

Kurznaht-Automat

Automatic short seamer

BASS 5110

Tel. 0049 6095/99233-0

Fax 0049 6095/99233-20

info@assag.de
www.assag.de

BENENNUNG	TAFEL PAGE	NAME
TISCHTEILE	1	TABLE PARTS
OBERTEILAUFHÄNGUNG	2	SEWING HEAD SUSPENSION
UNTERFADENWÄCHTER	3	UNDER THREAD MONITOR
FUTTER- UND STOFFKLEMMEN	4	LINING- AND FABRIC CLAMP
VENTILVERTEILUNG	5	VALVE BLOCK
ABLAGETISCH	6	DEPOSITING TABLE
OBERTEIL-MONTAGE (JUKI)	7	SEWING HEAD - MOUNTING (JUKI)
KLAMMERDRUCKVERSTÄRKUNG (JUKI)	8	CLAMP PRESSURE REINFORCEMENT (JUKI)
ANTRIEB-OBERTEIL (JUKI)	9	DRIVE (JUKI)
KLAMMERTRANSPORT	10	CLAMP TRANSPORT
KLAMMER	11	CLAMP
STAPLER	12	STACKER
VAKUUMEINRICHTUNG	13	VACUUM UNIT

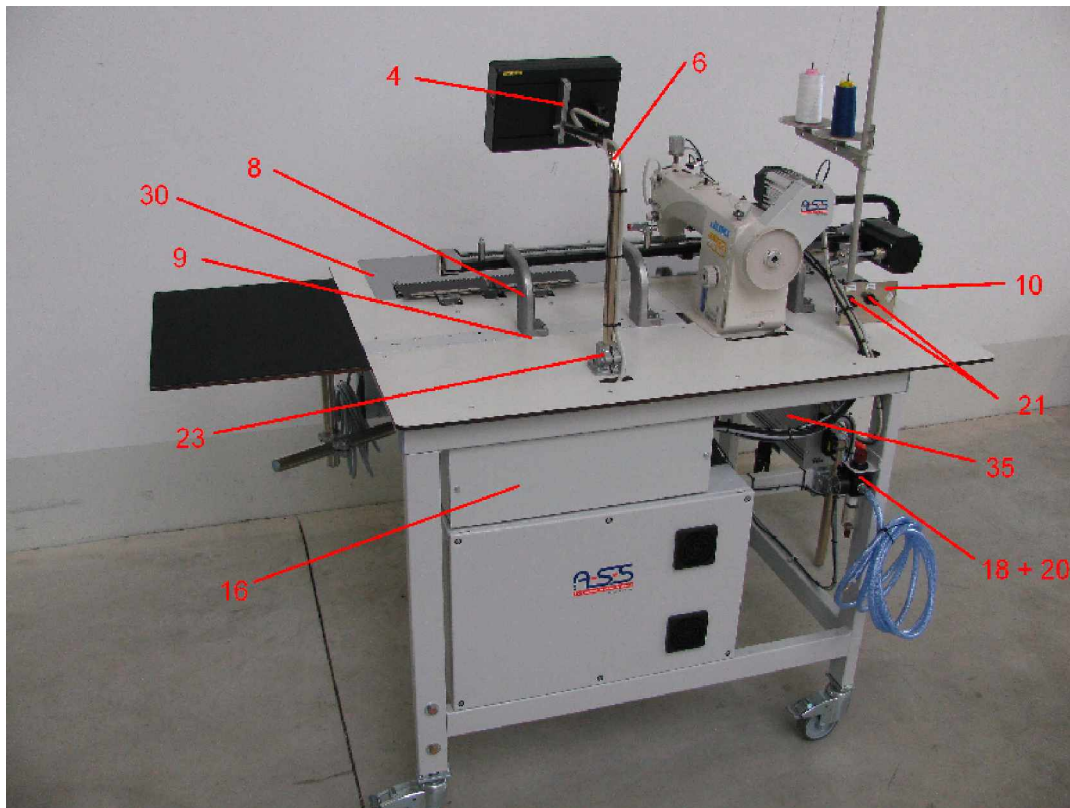
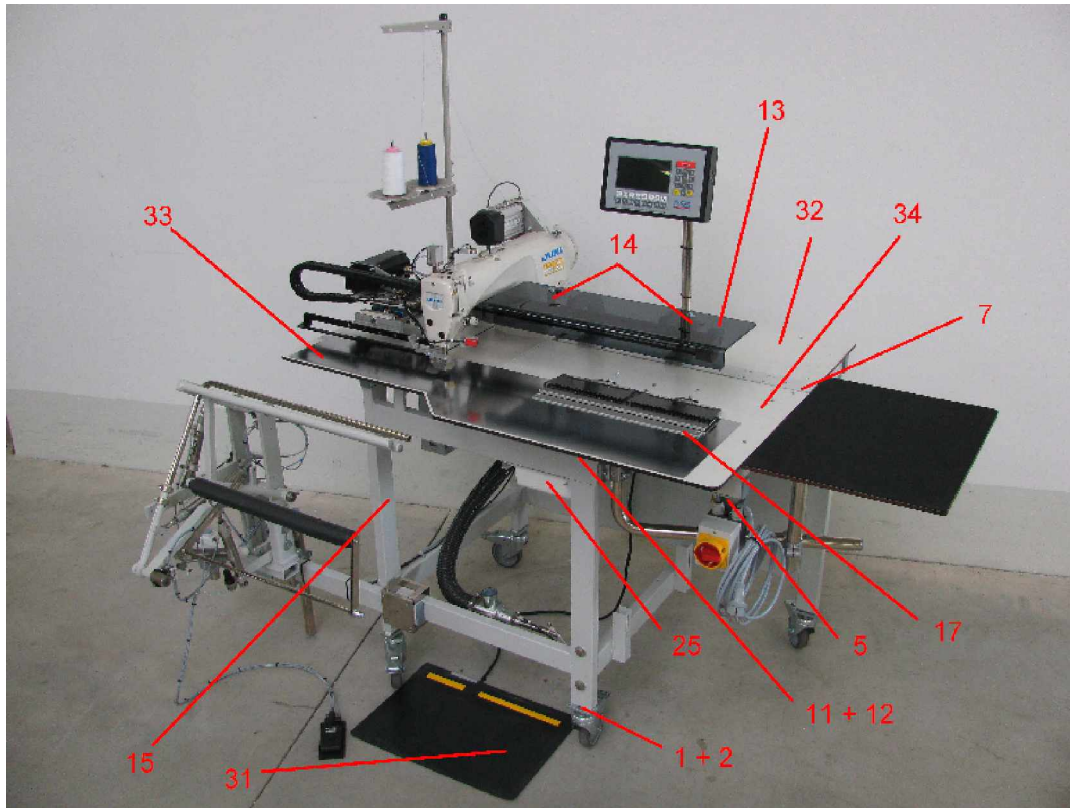

BASS 5110

Tischteile

Tafel 1.0

NR. NO.	ARTIKEL NR. ARTICLE NO.	BEZEICHNUNG	NAME	ST. Q'ty
1	030-0012-00	Stellfuss	set foot	4
2	030-0013-00	Halter	holder	4
4	030-0566-00	Lasche	plate	1
5	030-0714-00	Winkel	square	1
6	030-0754-00	Bedienfeldhalter	holder	1
7	030-2002-00	Grundplatte	baseplate	1
8	030-2003-00	Halter	holder	3
9	030-2004-00	Distanzplatte	shim	3
10	030-2005-00	Winkel	square	1
11	030-2007-00	Vakuumkasten	vacuum box	1
12	030-2008-00	Stutzen	connection piece	1
13	030-2035-00	Abdeckhaube	cover plate	1
14	030-2036-00	Stehbolzen	stay bolt	3
15	030-2982-00	Tischgestell	tabel frame	1
16	030-2983-00	Abdeckung	cover	1
17	030-3487-00	Anschlagleiste	stop bar	1
18	044-13255-00	Verschraubung	screwing	1
20	045-12272-96	Filterregler	air service unit	1
21	045-12274-00	Druckregler	pressure regulator	1
22	050-11252-00	Schlauchklemme	tube clamp	1
23	050-16434-00	Klemme	clamp	1
25	050-24818-00	PVC - Schubfach	drawer	1
30	050-27191-80	Schraube	screw	2
31	060-25910-00	Schaltmatte	switch mad	1
32	030-2001-00	Tischplatte	tabel plate	1
33	030-3489-00	Gleitblech	slide plate	1
34	030-3490-00	Tischplatte	tabel plate	1
35	060-24826-52	Steuerung	control	1

BASS 5110

Tischteile

Tafel 1.0

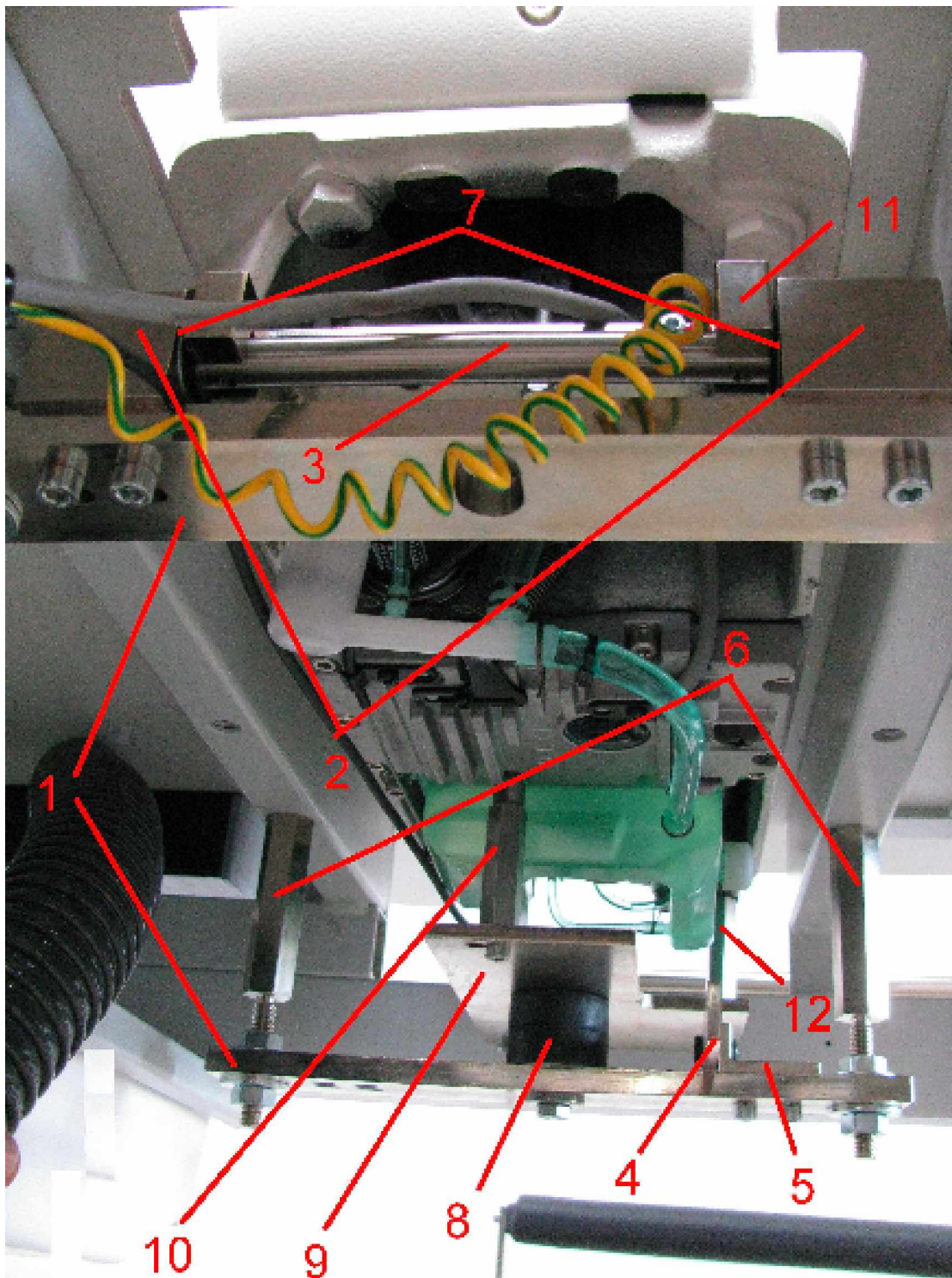

BASS 5110

Oberteilaufhängung

Tafel 2.0

NR. NO.	ARTIKEL NR. ARTICLE NO.	BEZEICHNUNG	NAME	ST. Q'ty
1	030-2010-00	Träger	girder	2
2	030-2011-00	Lagerbock	bearing bracket	2
3	030-2012-00	Welle	shaft	1
4	030-2013-00	Stütze	support	1
5	030-2015-00	Winkel	square	1
6	030-2133-00	Stehbolzen	bolt	2
7	050-16499-00	Buchse	sleeve	2
8	050-16521-00	Gummi-Metall-Puffer	isolator	1
9	030-2914-00	Platte	plate	1
10	030-2917-00	Stehbolzen	stay bolt	1
11	030-2915-00	Lagerbock	bearing block	1
12	030-2660-00	Stehbolzen	stay bolt	2
BASS 5110		Oberteilaufhängung		Tafel 2.0

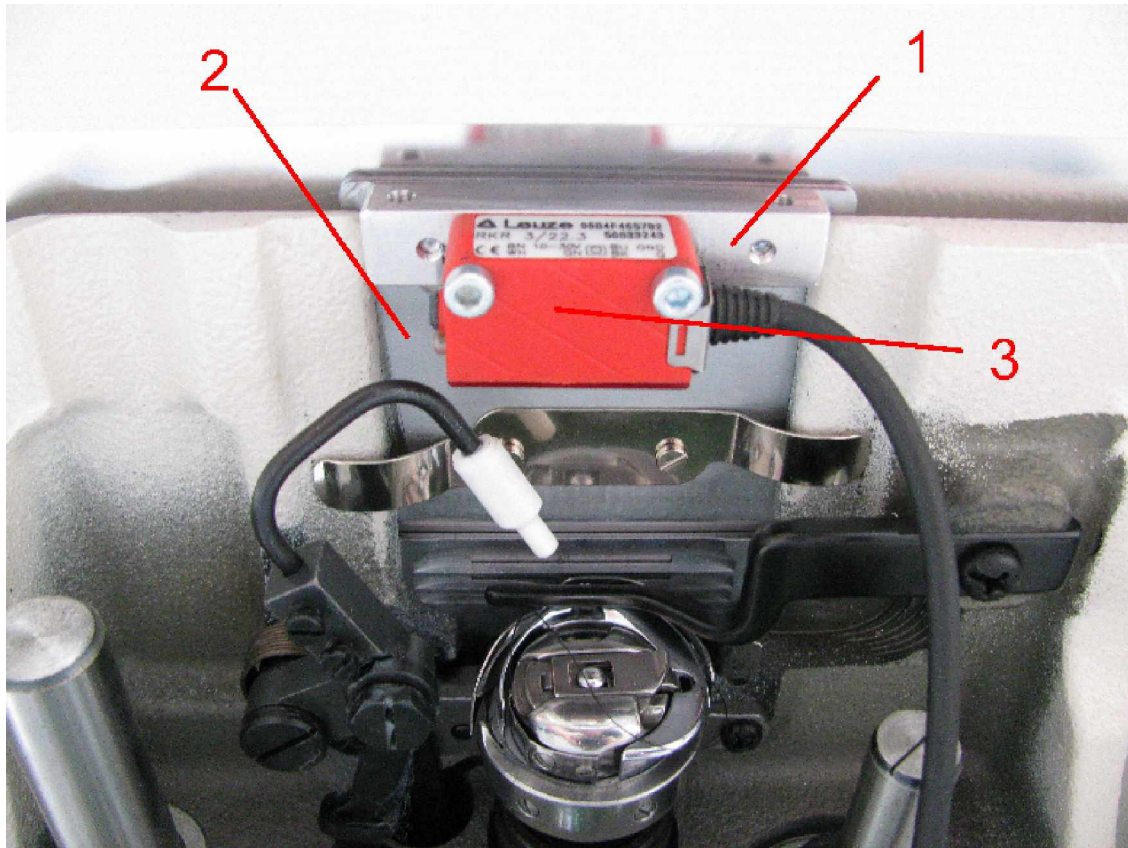

BASS 5110

Unterfadenwächter

Tafel 3.0

NR. NO.	ARTIKEL NR. ARTICLE NO.	BEZEICHNUNG	NAME	ST. Q'ty
1	030-3493-00	Fotozellenhalter	photocell holder	1
2	030-3494-00	Schieber - Orig. JUKI	slider - orig. JUKI	1
3	060-21734-04	Fotozelle	photocell	1
BASS 5110		Unterfadenwächter		Tafel 3.0

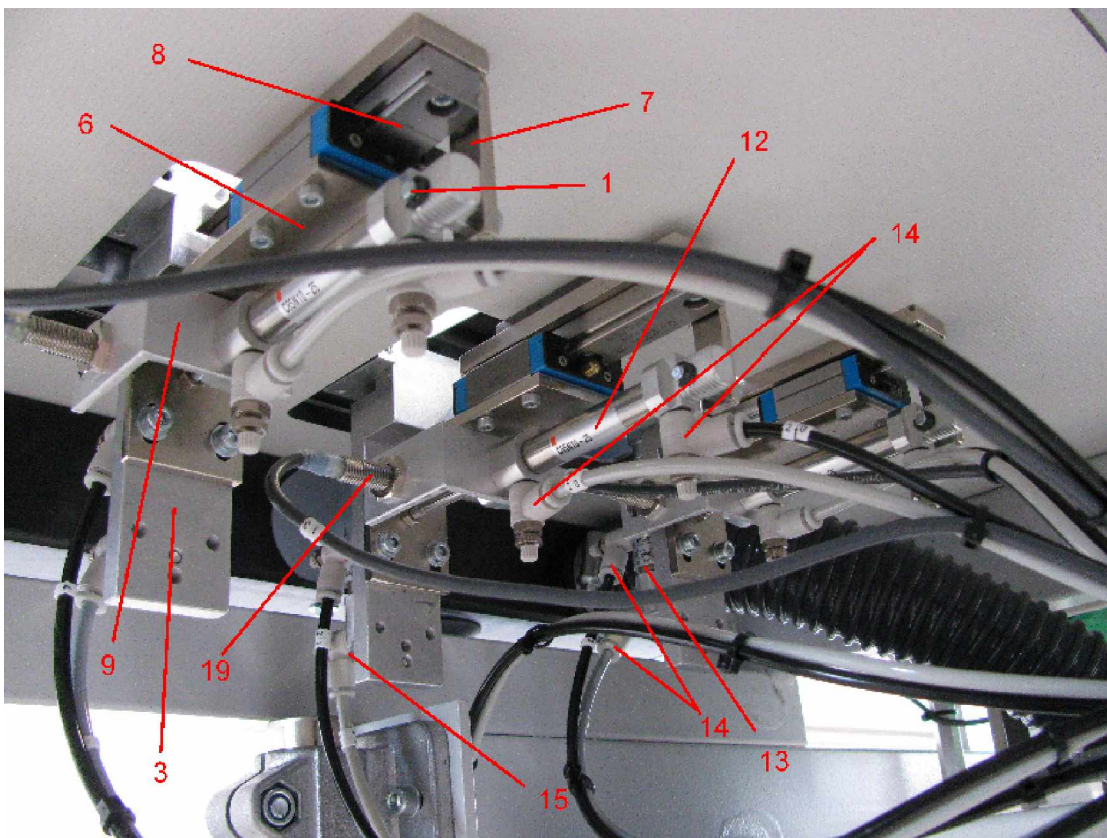
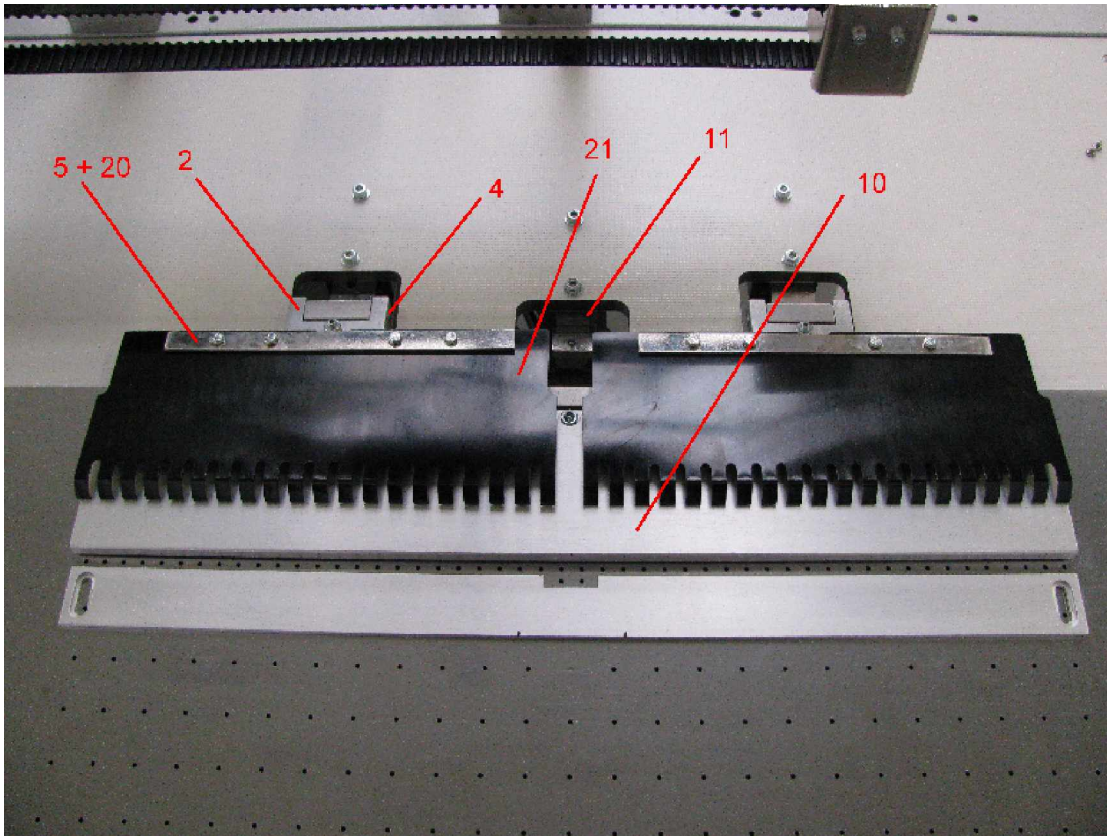

BASS 5110

Futter- und Stoffklemmen

Tafel 4.0

NR. NO.	ARTIKEL NR. ARTICLE NO.	BEZEICHNUNG	NAME	ST. Q'ty
1	030-0133-00	Stehbolzen	stay bolt	3
2	030-2098-00	Lager	bearing	3
3	030-2099-00	Halter	holder	3
4	030-2100-00	Welle	shaft	3
5	030-2101-00	Leiste	ledge	3
6	030-2104-00	Halter	holder	3
7	030-2105-00	Halter	holder	3
8	030-2106-00	Linearführung	linear motor guide	3
9	030-3484-00	Initiatorhalter	proximtiy switch holder	3
10	030-3485-00	Anschlagklemme	stop clamp	1
11	030-3486-00	Distanzlasche	distance plate	1
12	040-10025-20	Zylinder	cylinder	3
13	040-10045-00	Zylinder	cylinder	3
14	042-06927-00	Drossel	throttle valve	12
15	050-10102-00	L-Befestigung	L-fastening	3
16	050-18512-00	Gabelkopf	fork crown	3
17	050-18533-00	ES-Bolzen	ES-bolt	3
18	050-18534-00	Sicherungsscheibe	cir clip	3
19	060-21724-00	Initiator	proximtiy switch	3
20	030-2102-00	Lasche	lug	2
21	030-3488-00	Klemmblech	clamp tin	2
BASS 5110		Futter- und Stoffklemmen		Tafel 4.0

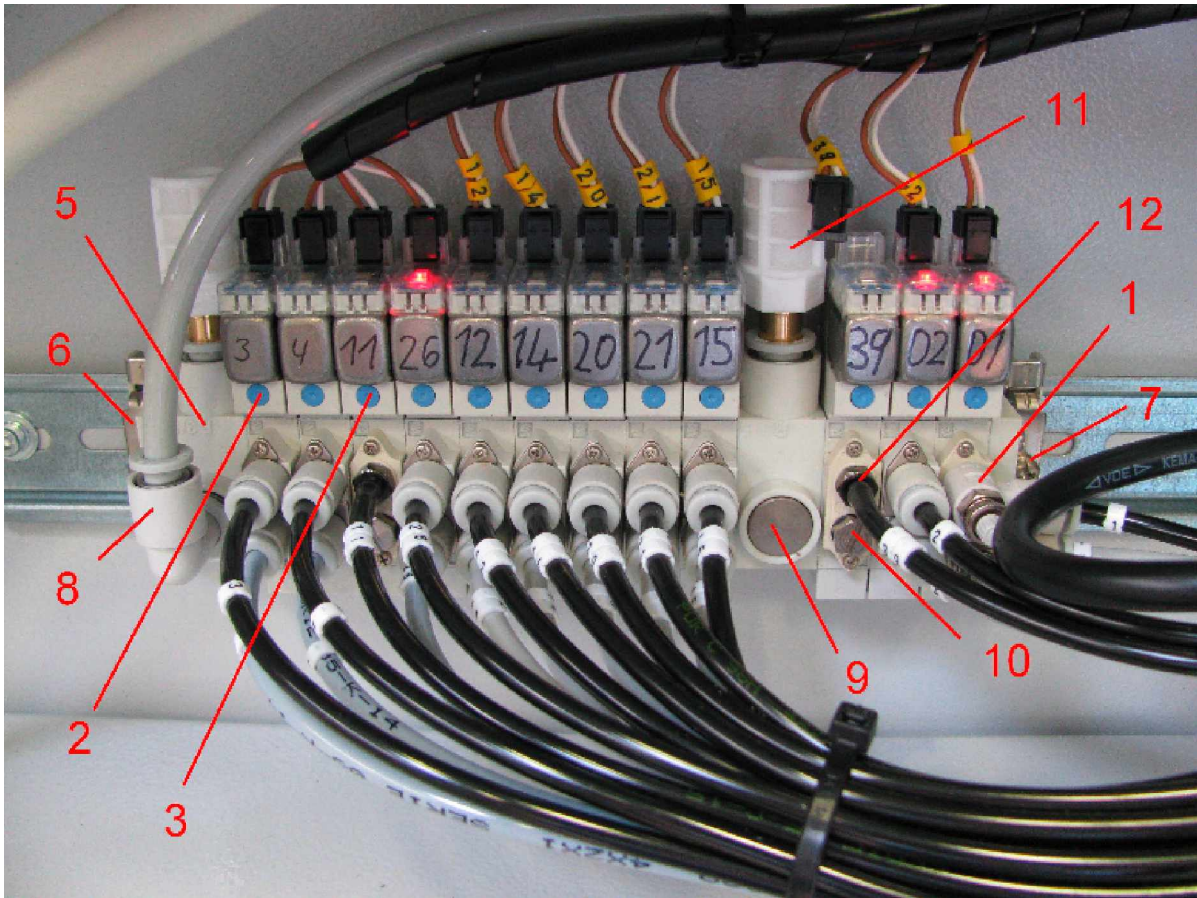

BASS 5110

Ventilverteilung

Tafel 5.0

NR. NO.	ARTIKEL NR. ARTICLE NO.	BEZEICHNUNG	NAME	ST. Q'ty
1	042-06927-00	Drossel	throttle valve	2
2	042-11400-00	Ventil	valve	9
3	042-11401-00	Ventil	valve	3
4	042-11402-00	Abtrenndichtung	seal	3
5	042-11403-00	P-Station	p-station	1
6	042-11404-00	Endplatte	end plate	1
7	042-11405-00	Endplatte	End plate	1
8	042-11407-00	Reduzierstück	reducer	1
9	042-11408-00	R-Station	r-station	1
10	044-13323-00	Verschraubung	screwing	4
11	044-13373-00	Schalldämpfer	sound absorber	2
12	044-14343-00	Verschraubung	screwing	3
BASS 5110		Ventilverteilung		Tafel 5.0

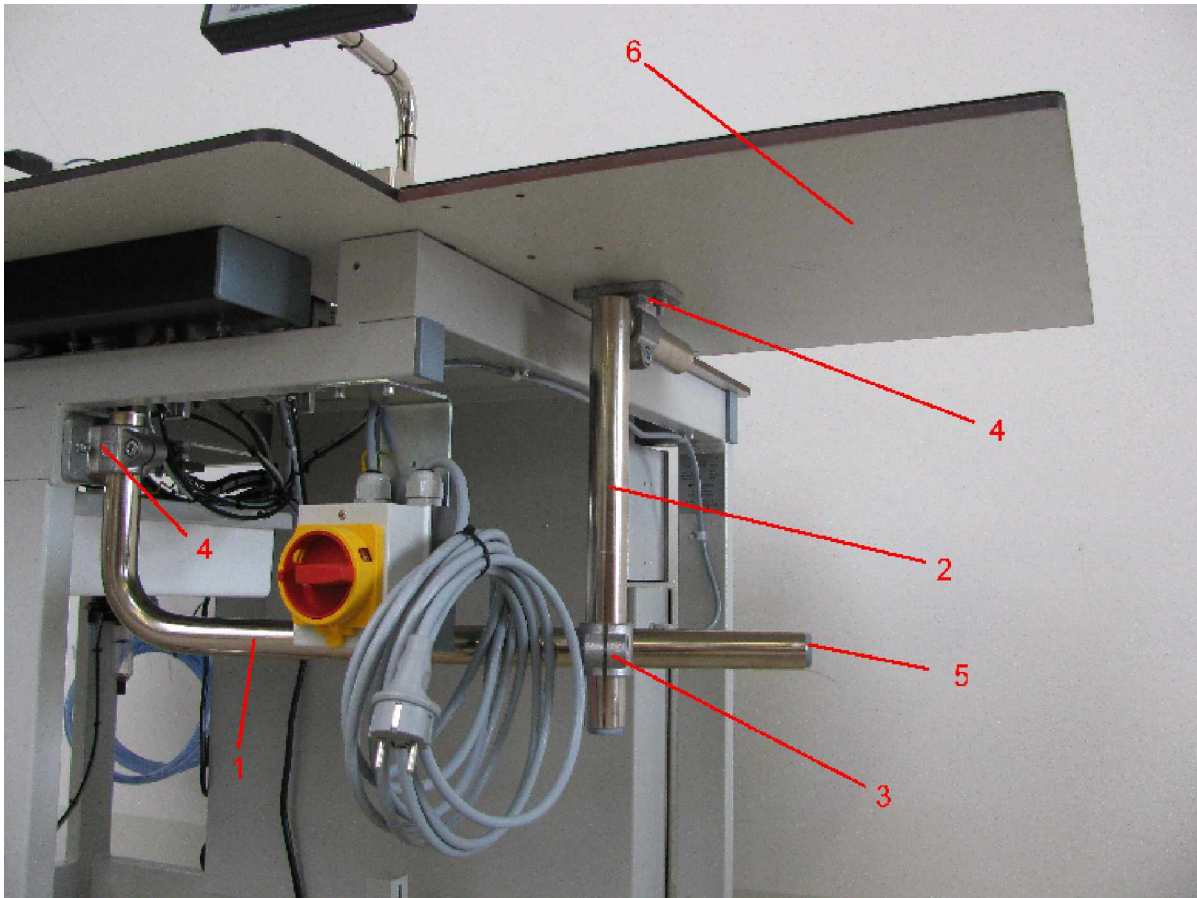

BASS 5110

Ablagetisch

Tafel 6.0

NR. NO.	ARTIKEL NR. ARTICLE NO.	BEZEICHNUNG	NAME	ST. Q'ty
1	030-2146-00	Winkelrohr	angle tube	1
2	030-2584-00	Winkelrohr	angle tube	1
3	050-16431-00	Klemme	clamp	1
4	050-16439-00	Klemme	clamp	2
5	050-25877-02	Kunststoffkappe	plastic plug	3
6	030-3253-00	Ablageplatte	shelf	1
BASS 5110		Ablagetisch		Tafel 6.0

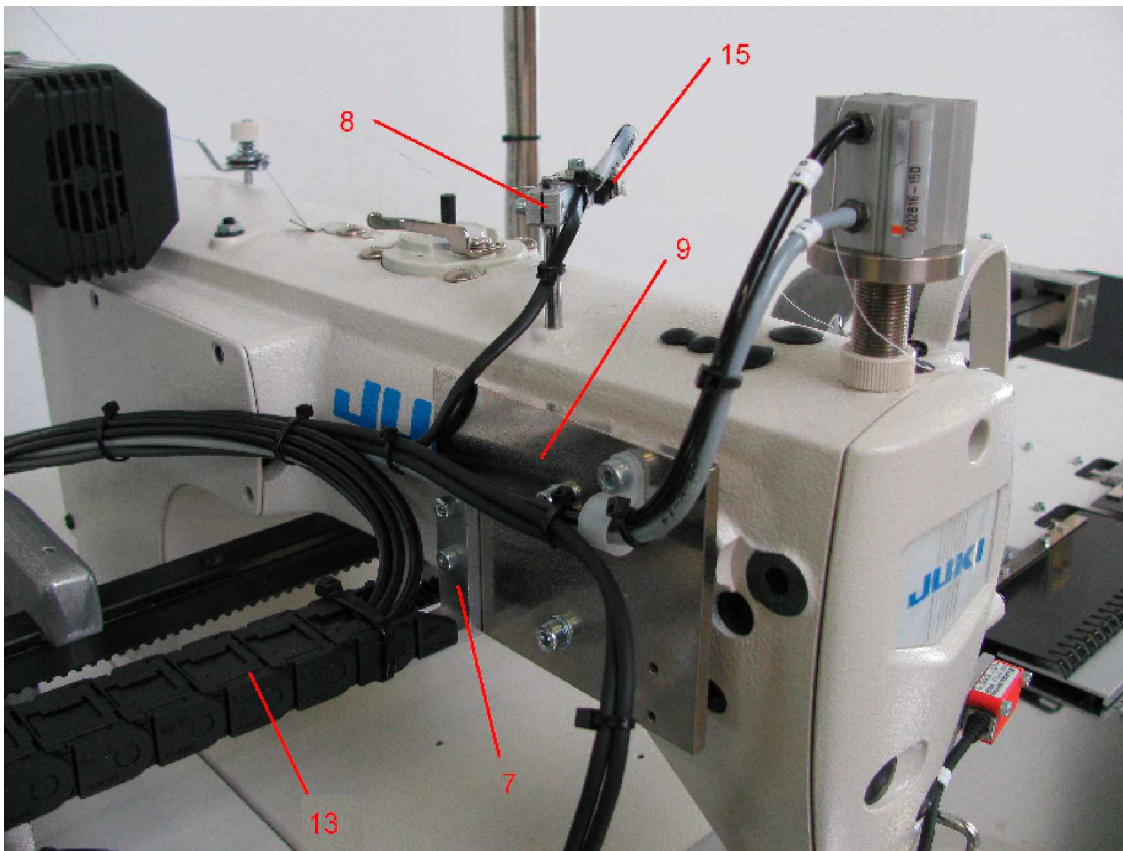
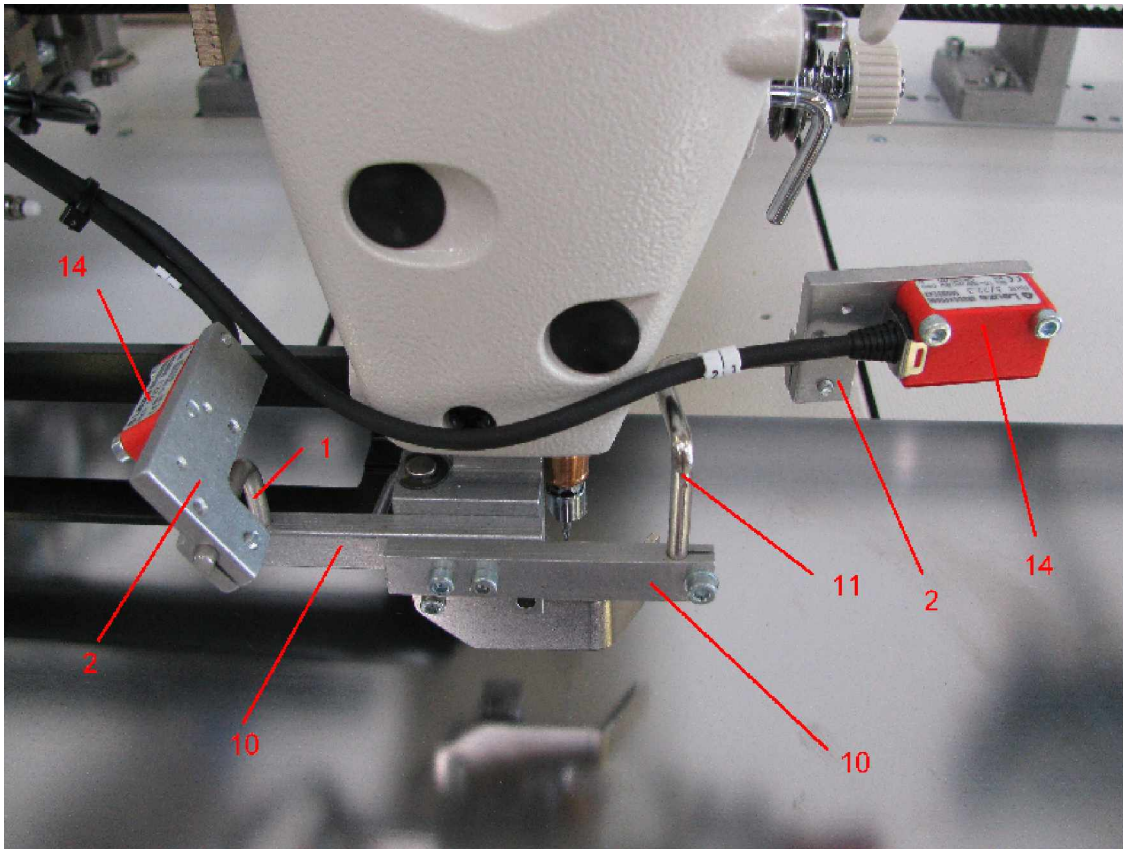

BASS 5110

Oberteil - Montage (JUKI)

Tafel 7.0

NR. NO.	ARTIKEL NR. ARTICLE NO.	BEZEICHNUNG	NAME	ST. Q'ty
1	030-0034-00	Halter	holder	1
2	030-0830-00	Fotozellenhalter	photocell holder	2
3	030-2660-00	Stehbolzen	stay bolt	2
7	030-2922-00	Winkel	angle	1
8	030-2921-00	Klemme	clamp	1
9	030-2923-00	Adapterplatte	adapter plate	1
10	030-3018-00	Klemme	clamp	2
11	030-3019-00	Halter	holder	1
12	030-3229-00-N	Deckel-Oberteil (JUKI)	cover (Juki)	1
13	050-25784-01	Energiekette	energy string	1
14	060-21743-04	Fotozelle	photocell	1
15	060-21754-00	Oberfadenwächter	sensor	1
BASS 5110		Oberteil - Montage (JUKI)		Tafel 7.0

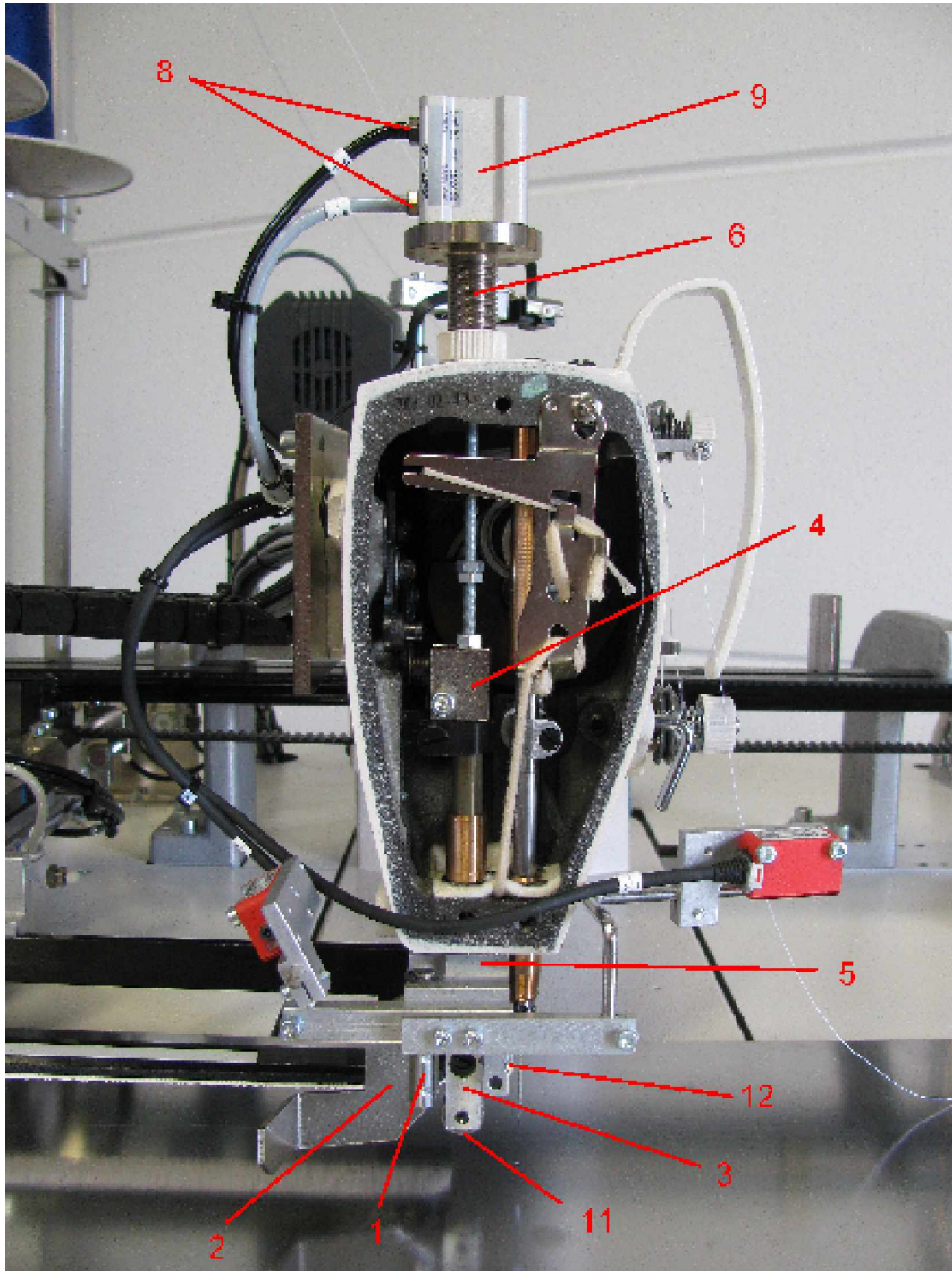

BASS 5110

Klammerdruckverstärkung

Tafel 8.0

NR. NO.	ARTIKEL NR. ARTICLE NO.	BEZEICHNUNG	NAME	ST. Q'ty
1	030-2032-00	Welle	shaft	1
2	030-2034-00	Fingerschutz	finger guard	1
3	030-2785-00	Halter	holder	1
4	030-2916-00	Klemme	clamp	1
5	030-2919-00	Halter	holder	1
6	030-3228-00	Halter	holder	1
8	044-14343-00	Verschraubung	screwing	2
9	041-16015-20	Zylinder	cylinder	1
11	050-15373-00	Kugellager	ball bearing	1
12	050-16490-00	Federndes Druckstück	spring loaded thrust pad	1
BASS 5110		Klammerdruckverstärkung		Tafel 8.0

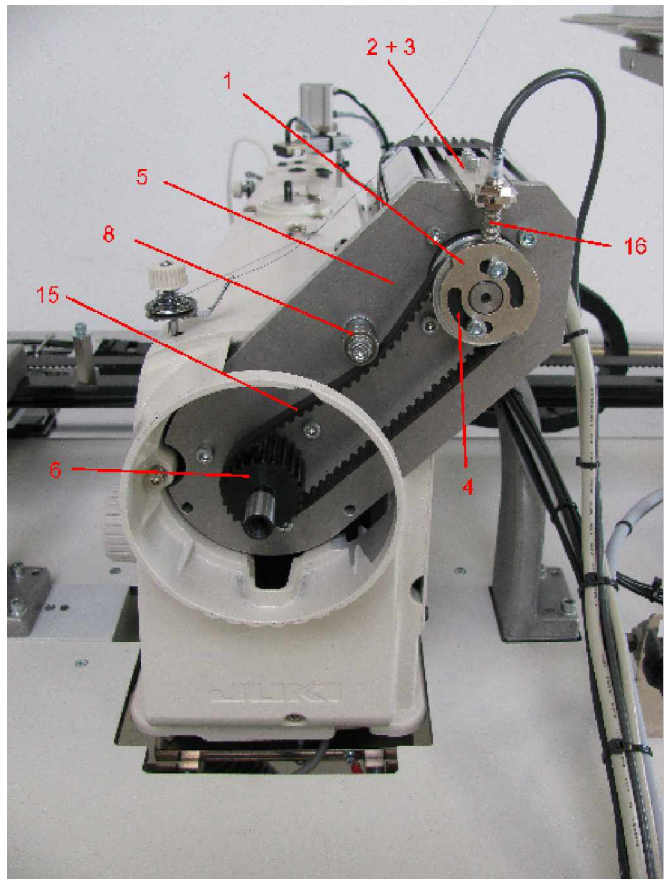
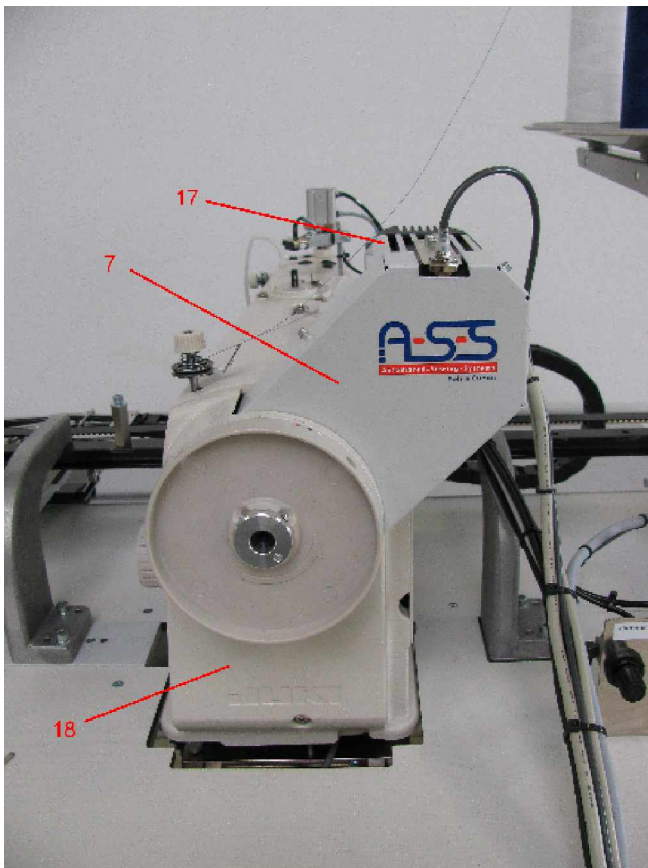

BASS 5110

Antrieb - Oberteil (JUKI)

Tafel 9.0

NR. NO.	ARTIKEL NR. ARTICLE NO.	BEZEICHNUNG	NAME	ST. Q'ty
1	030-2041-00	Kurvenscheibe	curve washer	1
2	030-2042-00	Lasche	cover plate	1
3	030-2043-00	Lasche	cover plate	1
4	030-2317-00	Synchrone Scheibe	disk	1
5	030-2662-00	Motorplatte	engine plate	1
6	030-2663-00	Zahnscheibe	toothed washer	1
7	030-2665-00	Schutz	guard	1
8	050-15374-00	Kugellager	ball bearing	2
15	050-25925-56	Zahnriemen	toothed belt guard	1
16	060-21724-10	Initiator	switch	1
17	060-24826-51	Motor	engine	1
18	030-3229-00-N	Deckel (JUKI)	cover (JUKI)	1
BASS 5110		Antrieb - Oberteil (JUKI)		Tafel 9.0

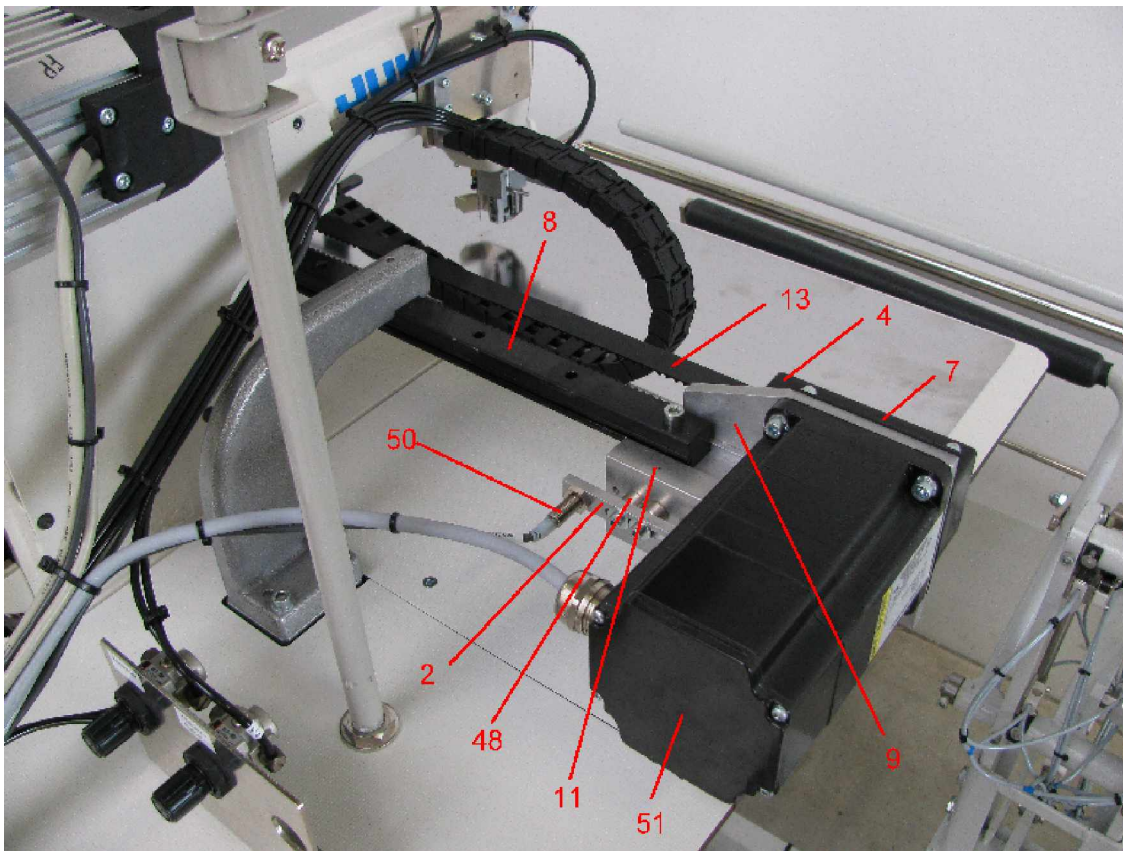
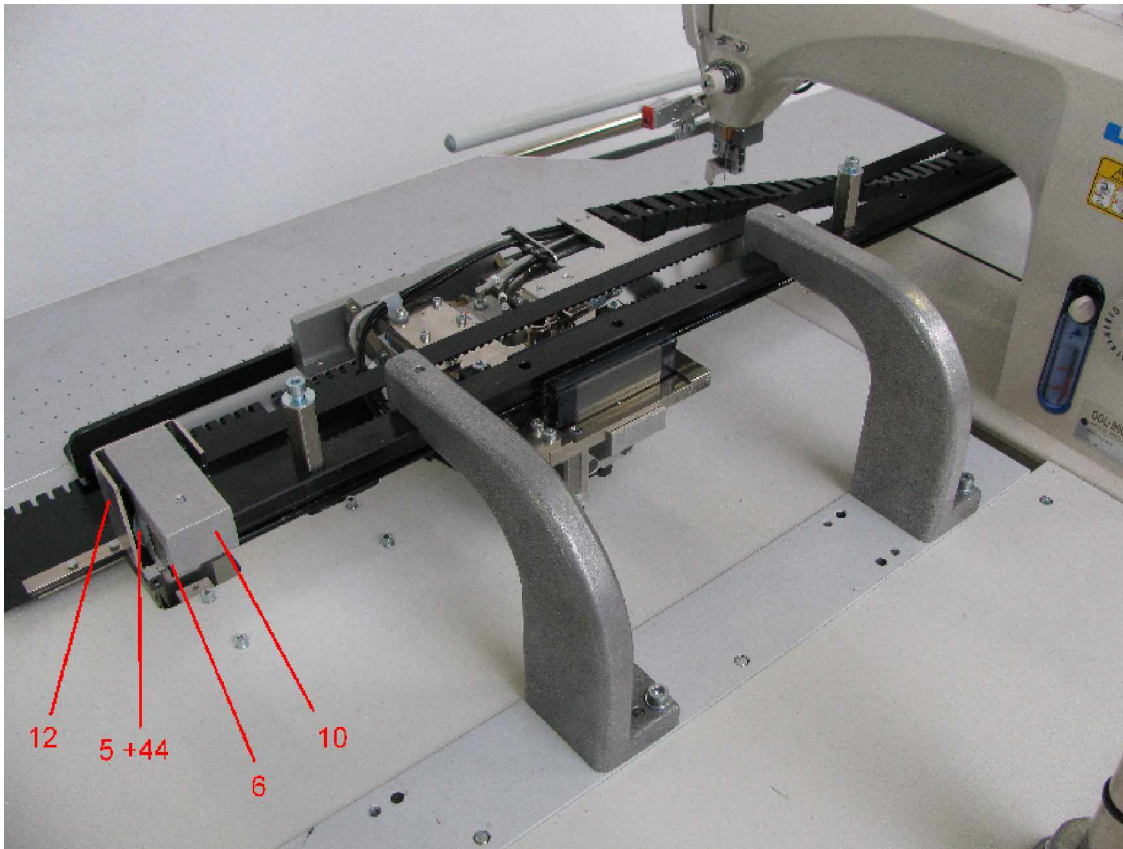

BASS 5110

Klammertransport

Tafel 10.0

NR. NO.	ARTIKEL NR. ARTICLE NO.	BEZEICHNUNG	NAME	ST. Q'ty
1	030-0102-00	Riemenklemme	belt clamp	2
2	030-0155-00	Halter	Holder	1
4	030-0584-00	Schutz	guard	1
5	030-0958-00	Synchronscheibe	synchronous disk	1
6	030-0959-00	Welle	shaft	1
7	030-0963-00	Zahnrad	gear wheel	1
8	030-2044-00	Linearführung	linear motor guide	1
9	030-2045-00	Motorplatte	engine plate	1
10	030-2046-00	Halter	holder	1
11	030-2047-00	Halter	holder	1
12	030-2048-00	Riemenschutz	belt guard	1
13	030-2049-00	Zahnriemen	belt	1
16	030-2053-00	Lagerbock	bearing pedestal	1
17	030-2054-00	Hebel	lever	1
18	030-2055-00	Lasche	cover plate	4
19	030-2057-00	Bolzen	bolt	1
20	030-2058-00	Halter	holder	1
21	030-2059-00	Stehbolzen	stay bolt	1
22	030-2060-00	Bolzen	bolt	2
23	030-2061-00	Welle	shaft	3
24	030-2062-00	Schraube	screw	1
25	030-2063-00	Scheibe	washer	1
27	030-2066-00	Anschlag	impact	1
28	030-2067-00	Vierkantmutter	nut	1
29	030-2068-00	Halter	holder	1
30	030-2069-00	Initiatorhalter	initiator holder	1
31	030-2070-00	Distanzplatte	shim	1
32	030-2071-00	Anschlag	impact	1
33	030-2072-00	Halter	holder	1
34	030-2073-00	Halter	holder	1
35	030-2074-00	Halter	holder	1
36	030-2189-00	Platte	plate	1
37	030-2341-00	Platte	plate	1
38	040-16080-00	Zylinder	cylinder	1
39	041-16020-00	Zylinder	cylinder	1
40	041-20010-00	Zylinder	cylinder	1
41	042-06927-00	Drossel	throttle valve	2
42	044-14340-00	Verschraubung	screwing	2
43	044-14341-00	Verschraubung	screwing	1
44	050-15377-00	Kugellager	ball bearing	2
45	050-15435-00	Buchse	sleeve	8
47	050-15483-00	Linearführung	linear motor guide	2
48	050-16465-00	Stelling	set collar	2
49	060-21724-00	Schalter	switch	1
50	060-21725-00	Schalter	switch	1
51	060-21221-07	Schrittmotor	stepping motor	1
BASS 5110		Klammertransport		Tafel 10.0

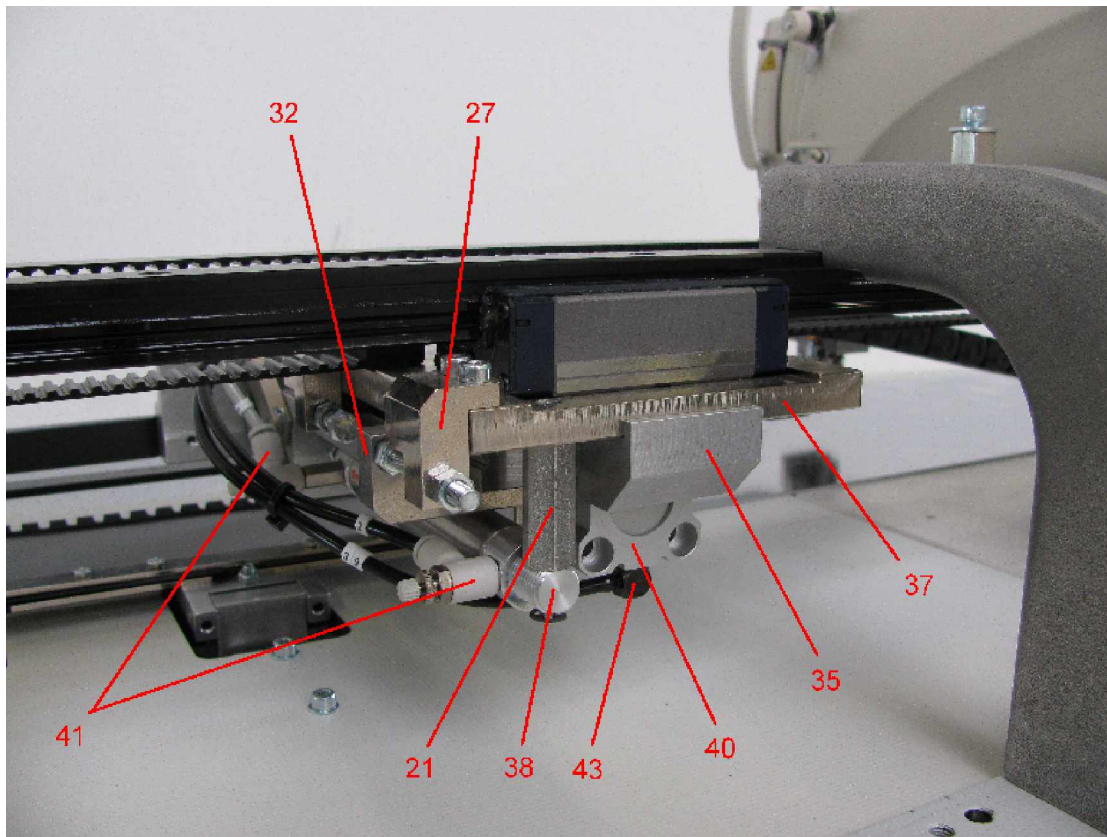
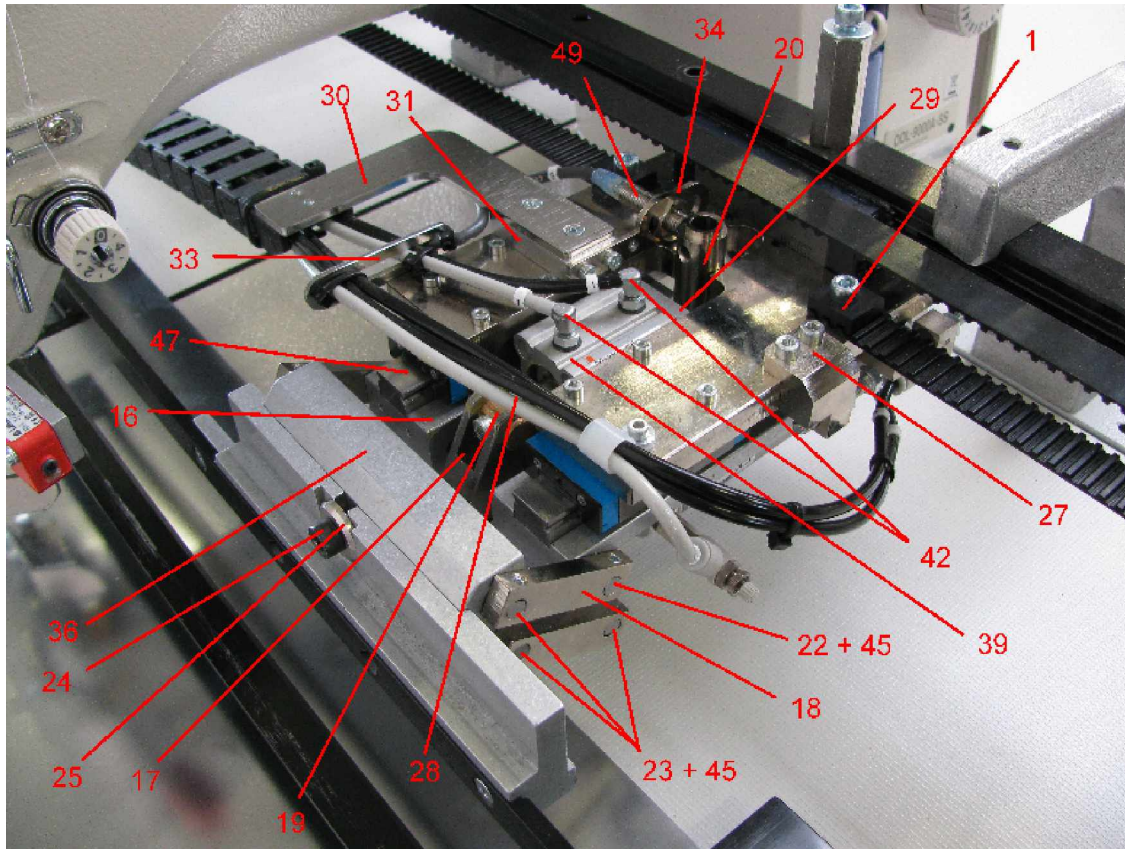

BASS 5110

Klammertransport

Tafel 10.1

NR. NO.	ARTIKEL NR. ARTICLE NO.	BEZEICHNUNG	NAME	ST. Q'ty
1	030-0102-00	Riemenklemme	belt clamp	2
2	030-0155-00	Halter	Holder	1
4	030-0584-00	Schutz	guard	1
5	030-0958-00	Synchronscheibe	synchronous disk	1
6	030-0959-00	Welle	shaft	1
7	030-0963-00	Zahnrad	gear wheel	1
8	030-2044-00	Linearführung	linear motor guide	1
9	030-2045-00	Motorplatte	engine plate	1
10	030-2046-00	Halter	holder	1
11	030-2047-00	Halter	holder	1
12	030-2048-00	Riemenschutz	belt guard	1
13	030-2049-00	Zahnriemen	belt	1
16	030-2053-00	Lagerbock	bearing pedestal	1
17	030-2054-00	Hebel	lever	1
18	030-2055-00	Lasche	cover plate	4
19	030-2057-00	Bolzen	bolt	1
20	030-2058-00	Halter	holder	1
21	030-2059-00	Stehbolzen	stay bolt	1
22	030-2060-00	Bolzen	bolt	2
23	030-2061-00	Welle	shaft	3
24	030-2062-00	Schraube	screw	1
25	030-2063-00	Scheibe	washer	1
27	030-2066-00	Anschlag	impact	1
28	030-2067-00	Vierkantmutter	nut	1
29	030-2068-00	Halter	holder	1
30	030-2069-00	Initiatorhalter	initiator holder	1
31	030-2070-00	Distanzplatte	shim	1
32	030-2071-00	Anschlag	impact	1
33	030-2072-00	Halter	holder	1
34	030-2073-00	Halter	holder	1
35	030-2074-00	Halter	holder	1
36	030-2189-00	Platte	plate	1
37	030-2341-00	Platte	plate	1
38	040-16080-00	Zylinder	cylinder	1
39	041-16020-00	Zylinder	cylinder	1
40	041-20010-00	Zylinder	cylinder	1
41	042-06927-00	Drossel	throttle valve	2
42	044-14340-00	Verschraubung	screwing	2
43	044-14341-00	Verschraubung	screwing	1
44	050-15377-00	Kugellager	ball bearing	2
45	050-15435-00	Buchse	sleeve	8
47	050-15483-00	Linearführung	linear motor guide	2
48	050-16465-00	Stelling	set collar	2
49	060-21724-00	Schalter	switch	1
50	060-21725-00	Schalter	switch	1
51	060-21221-07	Schrittmotor	stepping motor	1
BASS 5110		Klammertransport		Tafel 10.1

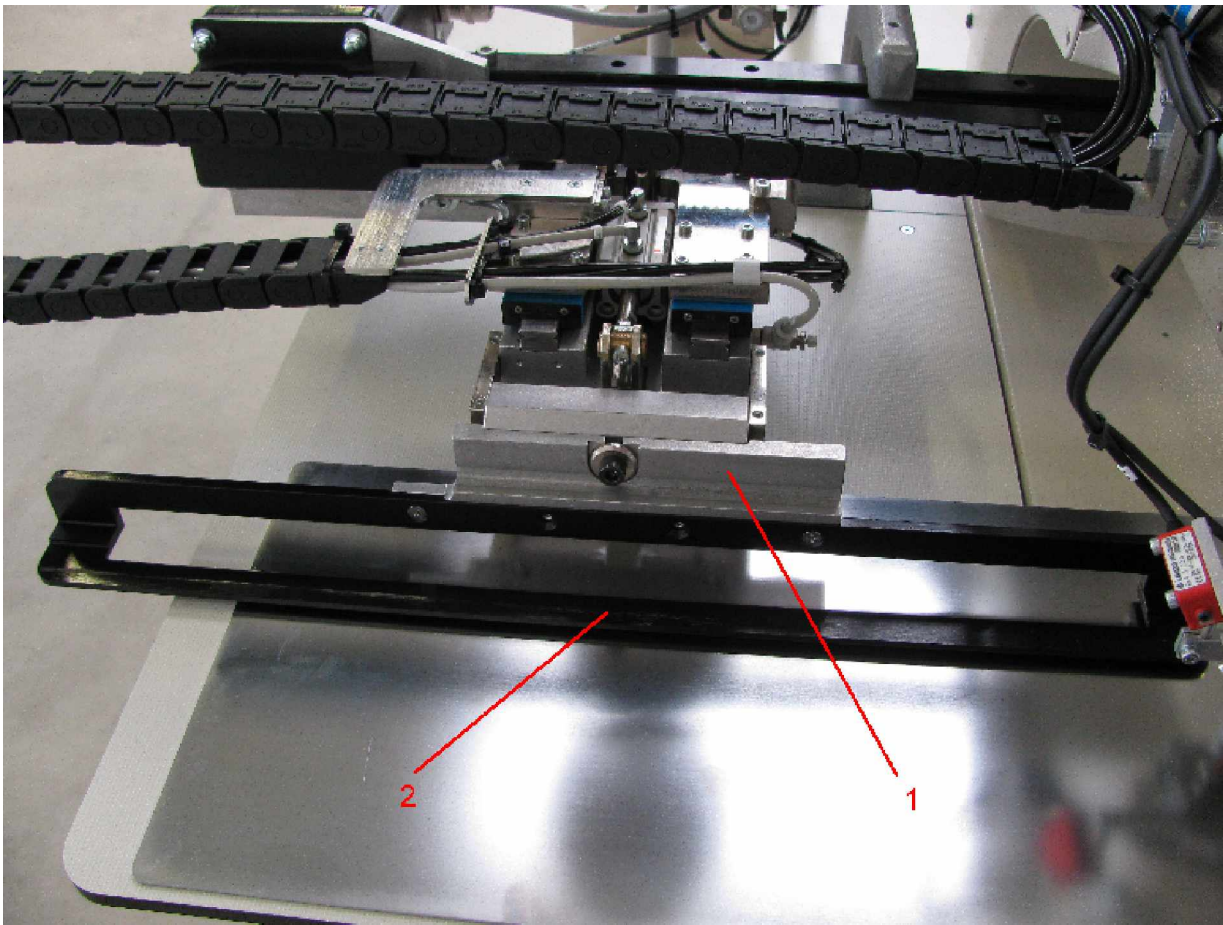

BASS 5110

Klammer

Tafel 11.0

NR. NO.	ARTIKEL NR. ARTICLE NO.	BEZEICHNUNG	NAME	ST. Q'ty
1	030-2340-00	Halter	holder	1
2	030-3491-00	Klammer	clamp	1
BASS 5110		Klammer		Tafel 11.0

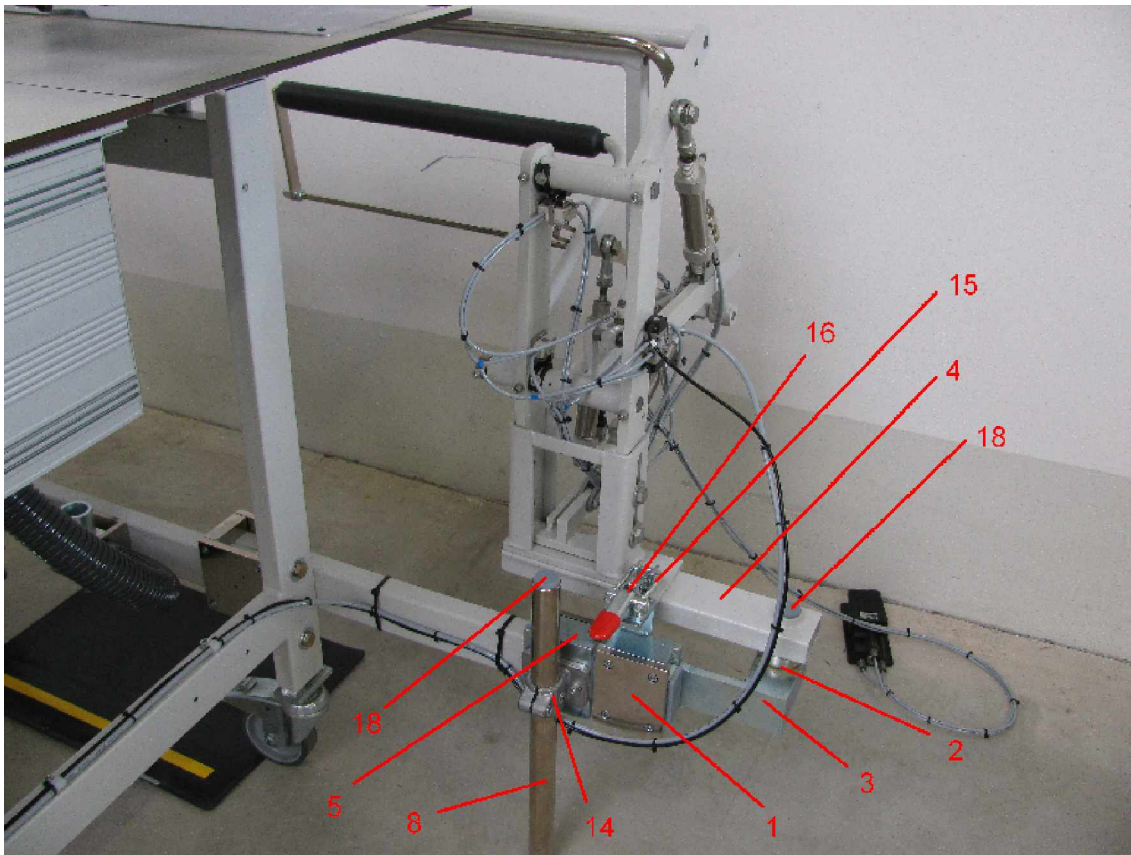
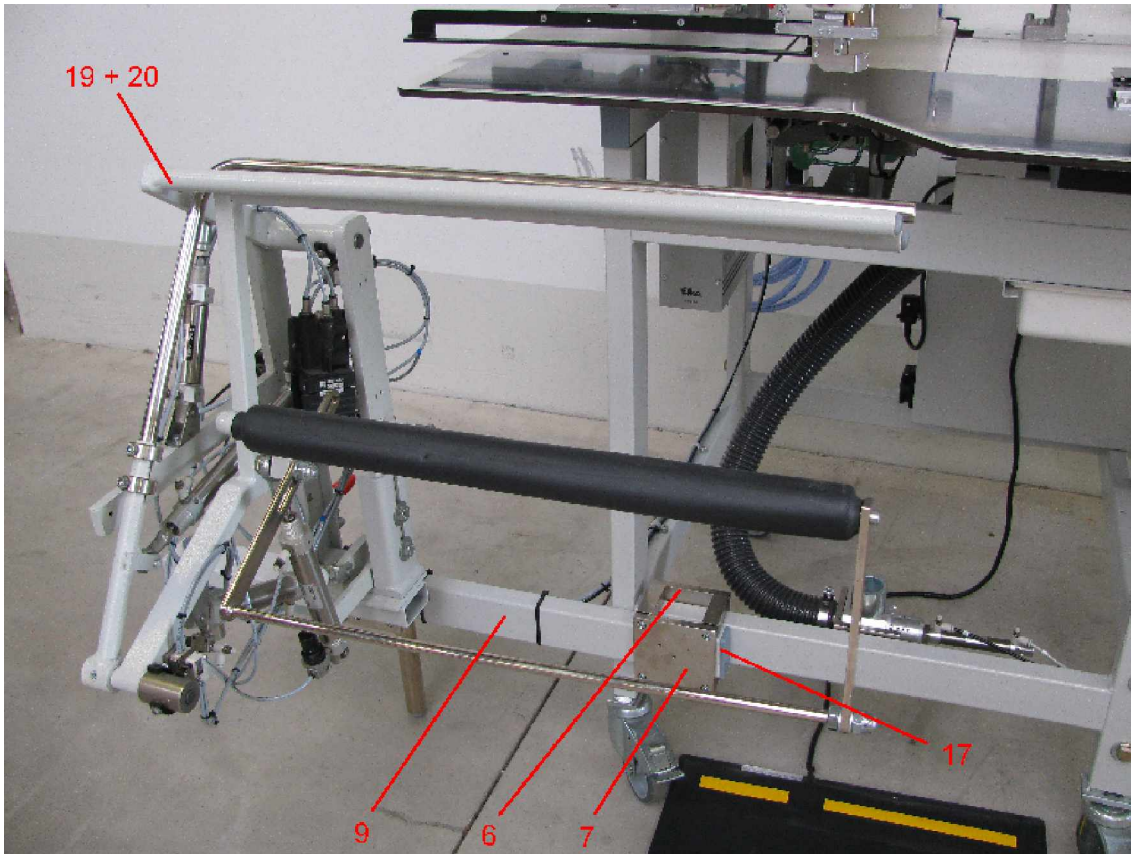

BASS 5110

Stapler 201/6

Tafel 12.0

NR. NO.	ARTIKEL NR. ARTICLE NO.	BEZEICHNUNG	NAME	ST. Q'ty
1	030-0056-00	Platte	plate	1
2	030-0140-00	Stelling	set collar	1
3	030-0449-00	Staplerklemme	stacker clamp	1
4	030-0445-00	Befestigung	fastening	1
5	030-0713-00	Klemme	clamp	1
6	030-1182-00	Klemme	clamp	1
7	030-1183-00	Platte	plate	1
8	030-1685-00	Rohr	tube	1
9	030-3492-00	Rohr	tube	1
10	042-06927-00	Drossel	throttle	1
11	044-11281-00	Schnellentlüftung	quick ventilation	1
12	044-13248-00	Schlauchverbindung	hose connection	1
13	044-13310-00	Verschraubung	screw joint	1
14	050-16439-00	Klemme	clamp	1
15	050-16465-00	Stelling	set collar	2
16	050-16514-00	Schnellverschluß	quick fastener	1
17	050-25873-00	Verschlußstopfen	stopper	2
18	050-25877-02	Verschlußstopfen	stopper	3
19	020-206810-45	Stapler 201/6	stacker 201/6	1
20	020-206810-45-01	Zusatzteile für kurze Ausführung	Additional part for short construction	1
BASS 5110		Stapler 201/6		Tafel 12.0

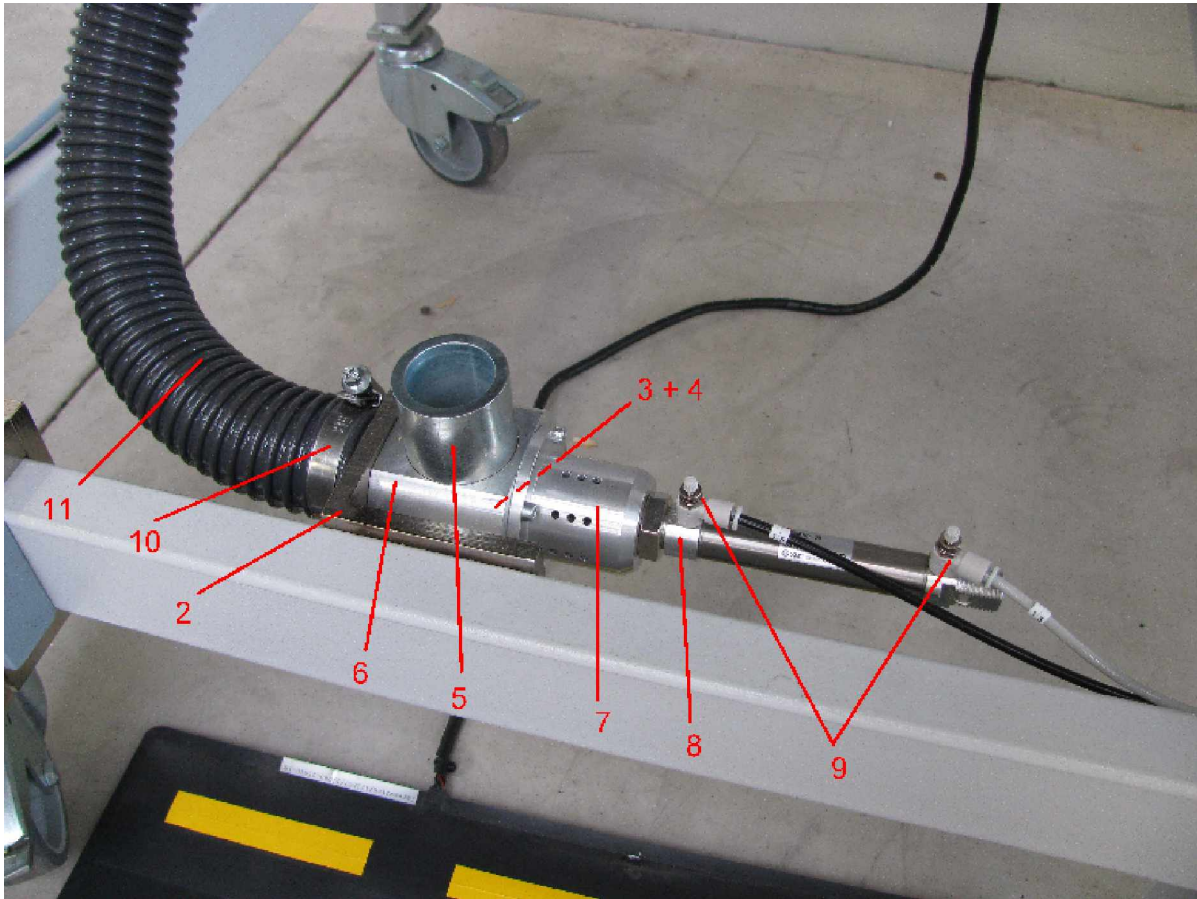

BASS 5110

Vakuumeinrichtung

Tafel 13.0

NR. NO.	ARTIKEL NR. ARTICLE NO.	BEZEICHNUNG	NAME	ST. Q'ty
2	030-0166-00	Halter	holder	1
3	030-0163-00	Schreibe	disk	1
4	030-0164-00	Distanzstück	distance piece	1
5	030-0165-00	Stutzen	connection piece	1
6	030-0161-00	Stutzen	casing	1
7	030-0162-00	Halter	holder	1
8	040-16050-20	Zylinder	cylinder	1
9	042-06927-00	Drossel	throttle valve	2
10	050-11252-00	Schlauchklemme	tube clamp	2
11	050-11254-00	Schlauch	tube	1
BASS 5110		Vakuumeinrichtung		Tafel 13.0