



TEILELISTE

Part list

Kurznaht - Automat
zum Annähen eines Plackbandes

Automatic short seamer
(to that sew on a plack binding)

BASS 8050

Tel. 0049 6095/99233-10

Fax 0049 6095/99233-20

info@assag.de
www.assag.de



A-S-S Automated-Sewing-Systems AG
Am Beetacker 3
D-63856 Bessenbach
Germany

Phone: +49 (0) 6095 99233-0
Fax: +49 (0) 6095 99233-20

E-Mail: info@assag.de
Internet: www.assag.de

Pocket Wadding Machines



Automatic Serging Machines



Automatic Joining Machines



Engineered Working Station



BENNENUNG	TAFEL PAGE	NAME
TISCHTEILE	1	TABLE PARTS
OBERTEILAUFHÄNGUNG	2	SEWING HEAD SUSPENSION
VENTILVERTEILUNG	3	VALVE BLOCK
OBERTEIL - MONTAGE (JUKI)	4	SEWING HEAD (JUKI)
ANTRIEB - JUKI-OBERTEIL	5	DRIVE (JUKI-SEWING HEAD)
SCHIEBETISCH	6	SLIDING TABLE
TRANSPORT	7	TRANSPORT
HUBTISCH	8	LIFTING TABLE
KONTURENFÜHRUNG	9	CONTOUR GUIDE

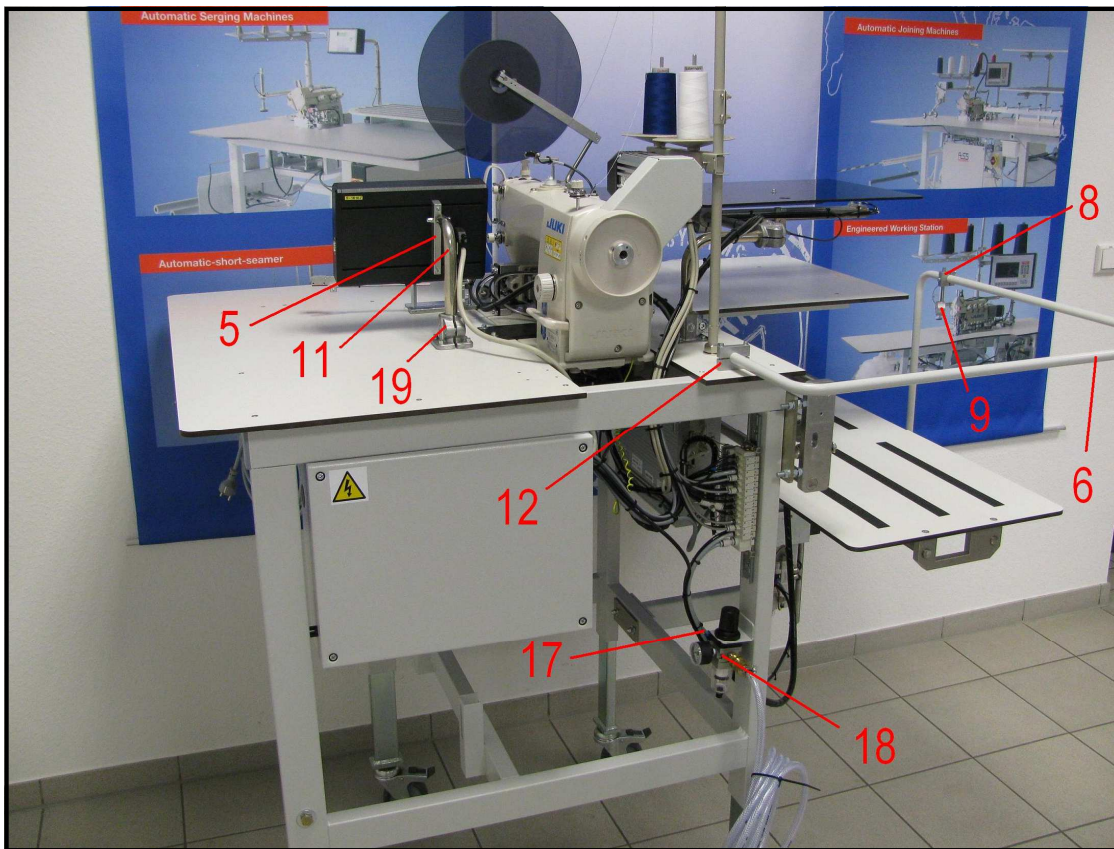
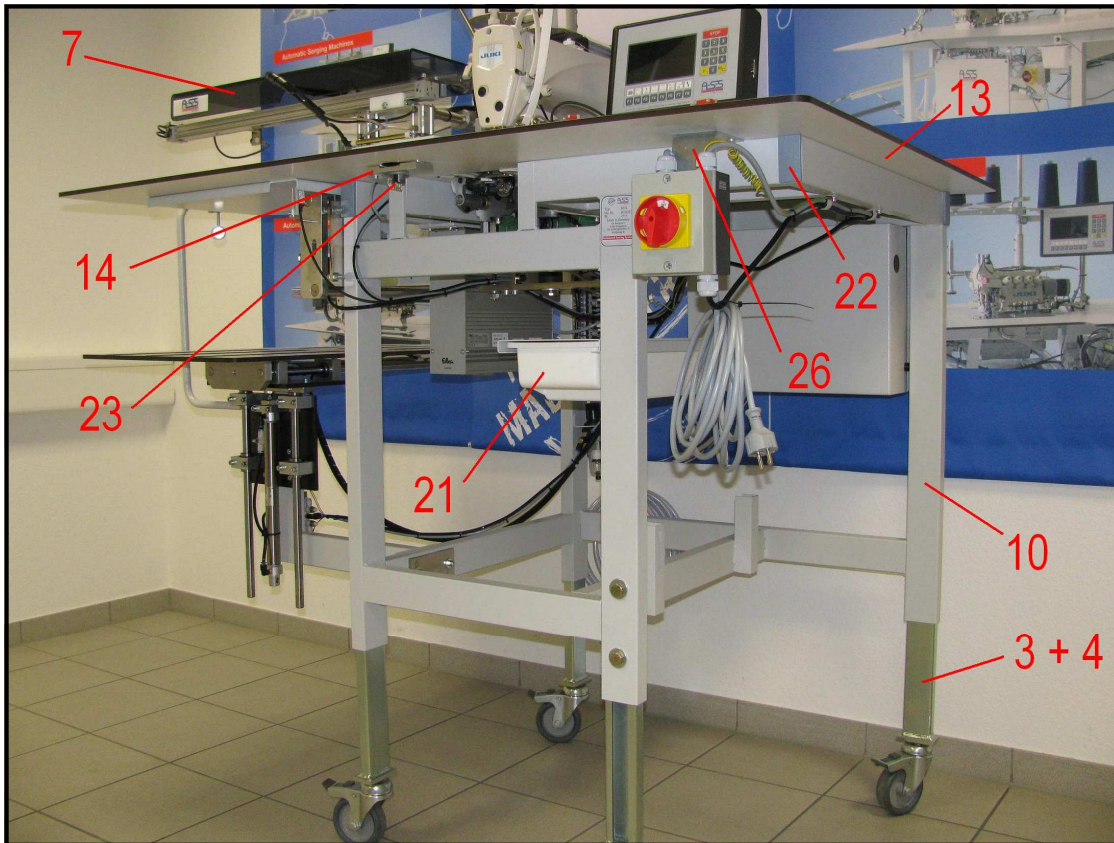

BASS 8050

Tischteile

Tafel 1.0

NR. NO.	ARTIKEL NR. ARTICLE NO.	BEZEICHNUNG	NAME	ST. Q`ty
3	030-0012-00	Stellfuß	table foot	4
4	030-0013-00	Halter	holder	4
5	030-0566-00	Lasche	cover plate	1
6	030-2152-00	Schutzbügel	stirrup	1
7	030-2155-00	Haube	cover	1
8	030-2206-00	Halter	holder	1
9	030-2207-00	Reflektor	reflector	1
10	030-2984-00	Tischgestell	table frame	1
11	030-3011-00	Bedienfeldhalter	control panel holder	1
12	030-3051-00	Klemme	clamp	1
13	030-3730-00	Tischplatte	table plate	1
14	030-3795-00	Halter	holder	1
17	044-13254-00	Verschraubung	screw jet	1
18	045-12272-96	Filterregler	filter control	1
19	050-16434-00	Klemme	clamp	1
21	050-24818-00	Schublade	drawer	1
22	050-25873-00	Rohrkappe	sealing plug	2
23	060-21772-00	Schalter	switch	1
26	030-0714-00	Halter	holder	1
BASS 8050		Tischteile		Tafel 1.0

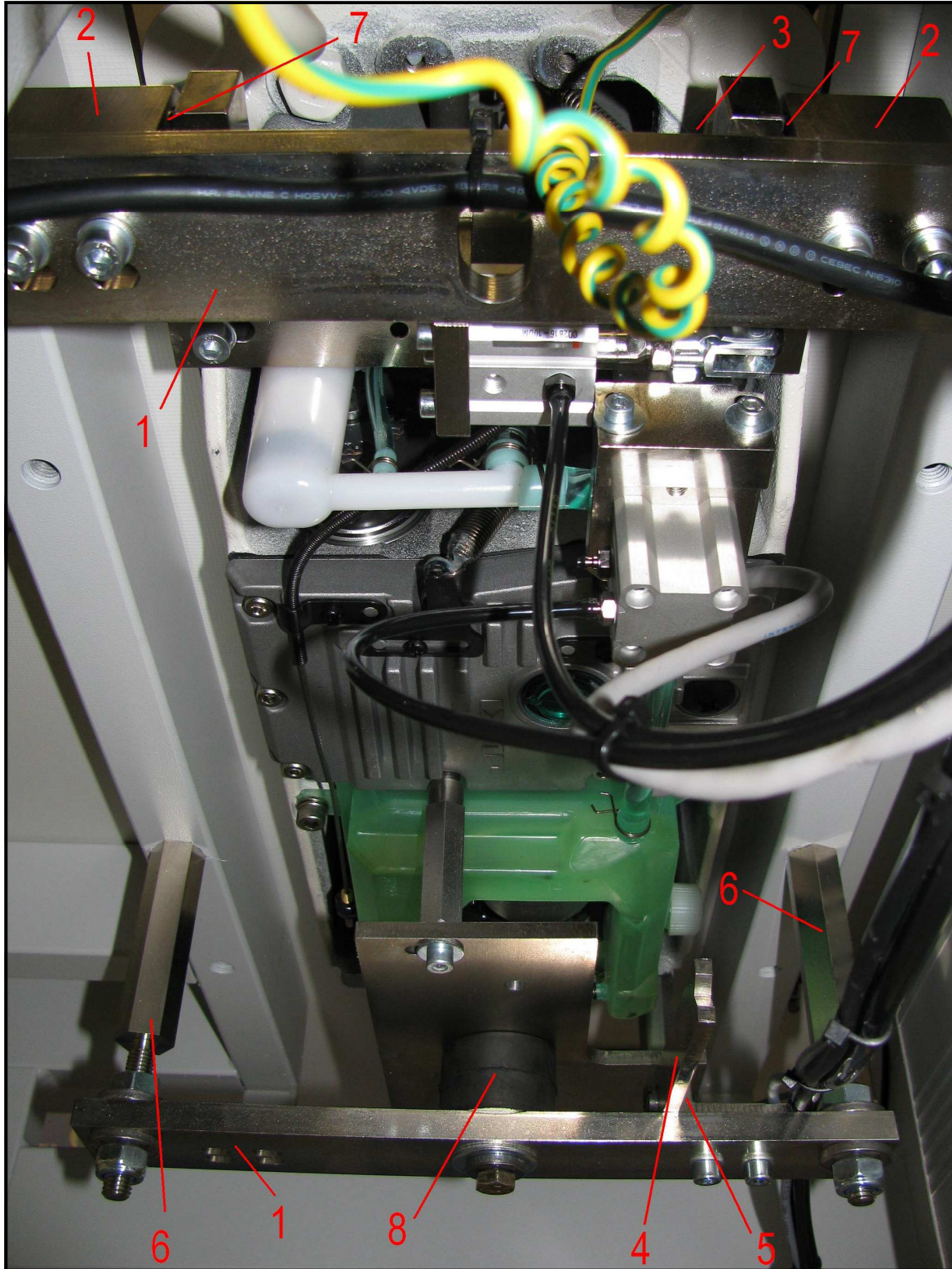

BASS 8050

Oberteilaufhängung

Tafel 2.0

NR. NO.	ARTIKEL NR. ARTICLE NO.	BEZEICHNUNG	NAME	ST. Q'ty
1	030-2010-00	Träger	porter	2
2	030-2011-00	Lagerbock	bearing block	2
3	030-2012-00	Welle	shaft	1
4	030-2013-00	Stütze	brace	1
5	030-2015-00	Winkel	angle	1
6	030-2133-00	Stehbolzen	stay bolt	2
7	050-16499-00	Buchse	bush	2
8	050-16521-00	Gummipuffer	rubber buffer	1
BASS 8050		Oberteilaufhängung		Tafel 2.0

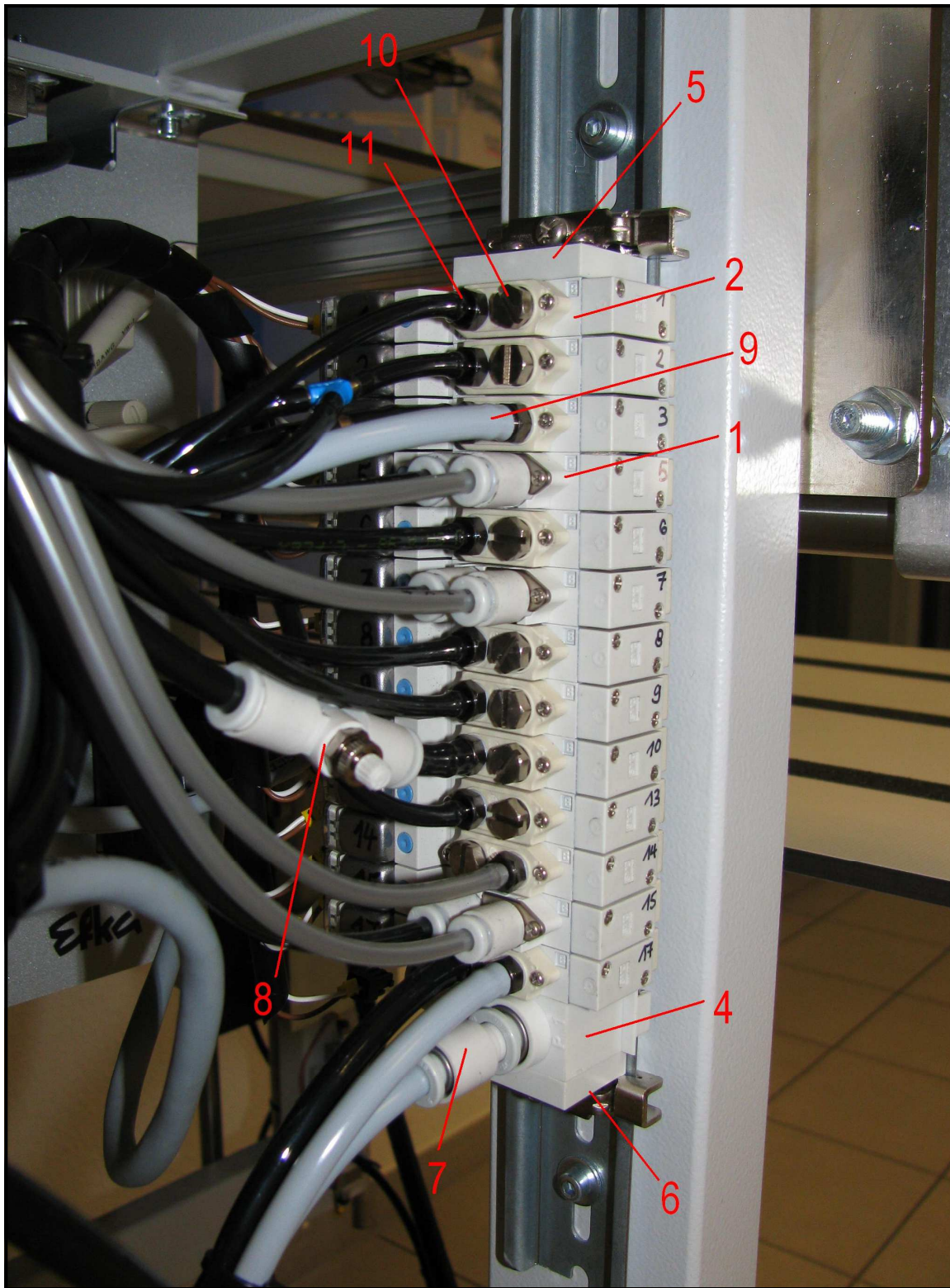

BASS 8050

Ventilverteilung

Tafel 3.0

NR. NO.	ARTIKEL NR. ARTICLE NO.	BEZEICHNUNG	NAME	ST. Q'ty
1	042-11400-00	Ventil	valve	3
2	042-11401-00	Ventil	valve	9
4	042-11403-00	P-Station	p-station	6
5	042-11404-00	Endplatte	end plate	1
6	042-11405-00	Endplatte	End plate	1
7	042-11406-00	Reduzierstück	reducer	1
8	042-11284-02	Drossel	throttle	1
9	044-13306-00	Verschraubung	screwing	3
10	044-13323-00	Verschraubung	screwing	8
11	044-14343-00	Verschraubung	screwing	7
BASS 8050		Ventilverteilung		Tafel 3.0

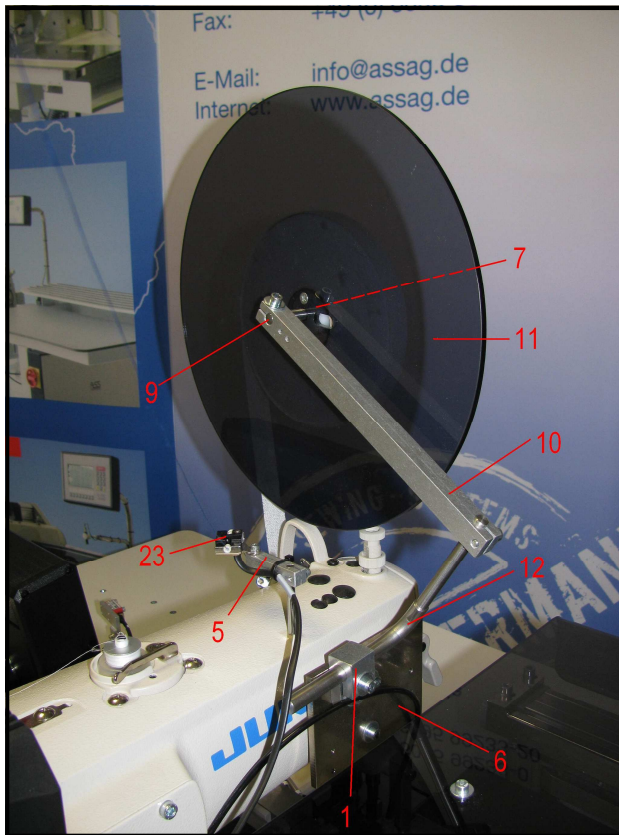
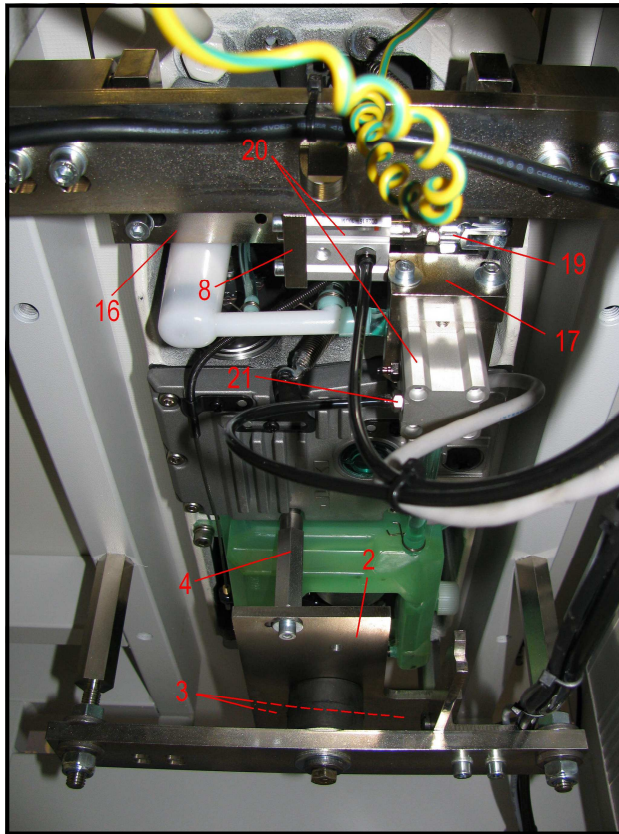

BASS 8050

Oberteil - Montage

Tafel 4.0

NR. NO.	ARTIKEL NR. ARTICLE NO.	BEZEICHNUNG	NAME	ST. Q'ty
1	030-2409-00	Klemme	clamp	1
2	030-2658-00	Platte	plate	2
3	030-2660-00	Stehbolzen	stay bolt	1
4	030-2917-00	Stehbolzen	stay bolt	1
5	030-2921-00	Klemme	clamp	1
6	030-2923-00	Adapterplatte	adapter plate	1
7	030-0261-00	Rollenhalter	roll holder	1
8	030-2926-00	Platte	plate	2
9	030-0263-00	Welle	shaft	1
10	030-0268-00	Leiste	flat rod	1
11	030-1186-00	Plexiglasscheibe	washer	1
12	030-3790-00	Winkelstück	angle piece	1
16	030-3793-00	Lagerbock	bearing block	1
17	030-3794-00	Distanzstück	distance piece	1
19	050-10099-00	L-Befestigung	mounting	1
20	041-16010-19	Zylinder	cylinder	2
21	044-14343-00	Verschraubung	screw joint	3
23	060-21754-11	Oberfadenwächter	needle thread monitor	1
BASS 8050		Oberteil - Montage		Tafel 4.0

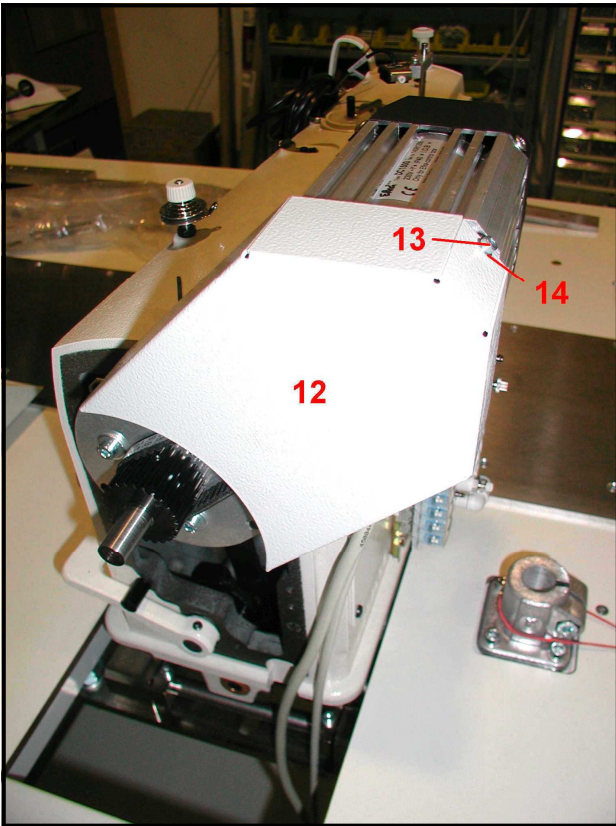
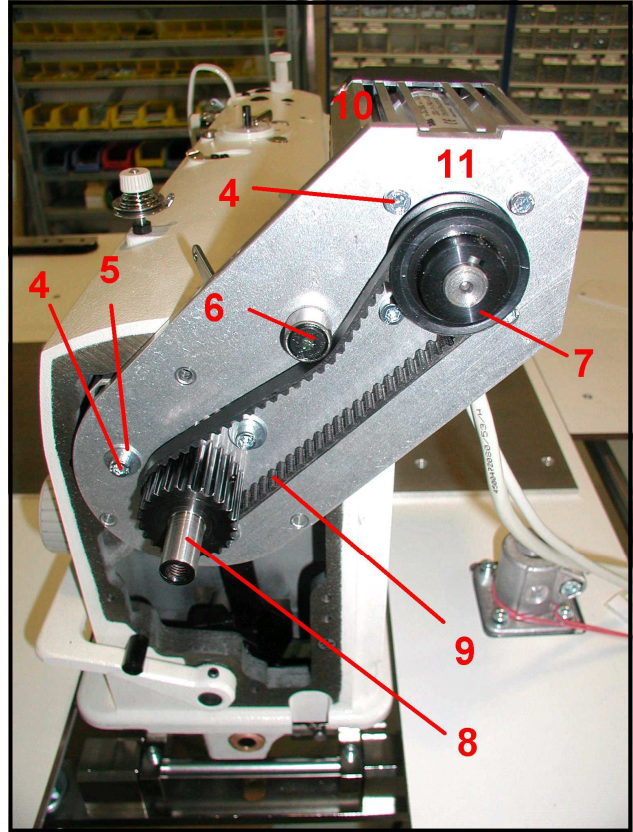
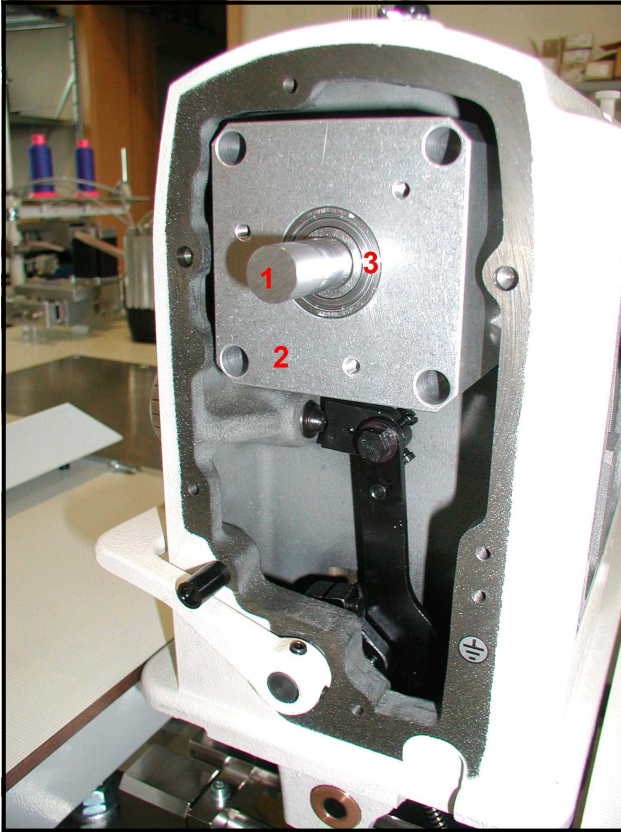

BASS 8050

Antrieb - Juki Oberteil

Tafel 5.0

NR. NO.	ARTIKEL NR. ARTICLE NO.	BEZEICHNUNG	NAME	ST. Q'ty
1	030-2920-00	Welle	shaft	1
2	030-2913-00	Führungsstück	guide piece	1
3	050-15381-10	Rillenkugellager	ball bearing	2
4	DIN 912 M5x20	Zylinderschraube	screw	7
5	DIN 9021 A5,3	Scheibe	washer	3
6	050-15366-00	Kurvenrolle	cam roller	1
7	030-2317-00	Zahnscheibe	toothed washer	1
8	030-2663-00	Zahnscheibe	toothed washer	1
9	050-25925-52	Zahnriemen	toothed belt	1
10	060-24826-51	Antrieb DC 1500	drive DC 1500	1
11	030-2662-00	Motorplatte	engine plate	1
12	030-2665-00	Schutz	cover	1
13	DIN 912 M3x8	Zylinderschraube	screw	3
14	DIN 125 A3,2	Scheibe	washer	3
BASS 8050		Antrieb - Juki Oberteil		Tafel 5.0

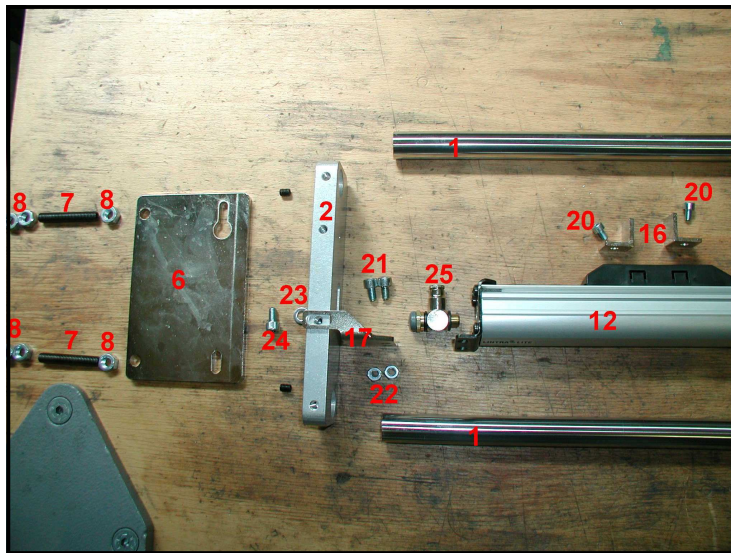
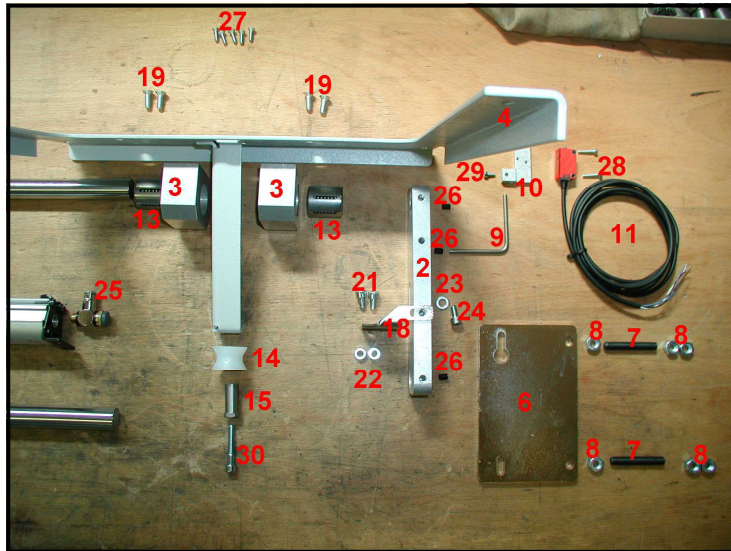

BASS 8050

Schiebetisch

Tafel 6.0

NR. NO.	ARTIKEL NR. ARTICLE NO.	BEZEICHNUNG	NAME	ST. Q'ty
1	030-2208-00	Welle	shaft	2
2	030-2209-00	Lasche	ledge	2
3	030-2210-00	Lagerbock	bearing bracket	2
4	030-2211-00	Wagen	carriage	1
5	030-2212-00	Platte	plate	1
6	030-2213-00	Halteplatte	holding plate	2
7	DIN 913 M8x55	Gewindestift	grub screw	4
8	DIN 934 M8	Mutter	nut	12
9	030-0942-00	Fotozellenhalter	photocell holder	1
10	030-0036-00	Fotozellenhalter	photocell holder	1
11	060-21724-00	Fotozelle	photocell	1
12	040-10236-02	Bandzylinder	cylinder	1
13	050-15522-00	Kugellager	ball bearing	2
14	030-2214-00	Stützrolle	support roller	1
15	030-2215-00	Excenterbolzen	eccentric bolt	1
16	030-2216-00	Winkel	square	2
17	030-2217-00	Winkel	square	1
18	030-2218-00	Winkel	square	1
19	DIN 7991 M6x16	Senkschraube	screw	4
20	DIN 912 M5x8	Zylinderschraube	screw	2
21	DIN 912 M6x10	Zylinderschraube	screw	4
22	DIN 934 M6	Mutter	nut	4
23	DIN 125 A6,4	Scheibe	washer	2
24	DIN 912 M6x12	Zylinderschraube	screw	2
25	044-14384-00	Verschraubung	screw joint	2
26	DIN 913 M6x8	Gewindestift	grub screw	5
27	DIN 7991 M4x12	Senkschraube	screw	5
28	DIN 912 M3x16	Zylinderschraube	screw	2
29	DIN 912 M3x8	Zylinderschraube	screw	1
30	DIN 912 M6x35	Zylinderschraube	screw	1
BASS 8050		Schiebetisch		Tafel 6.0

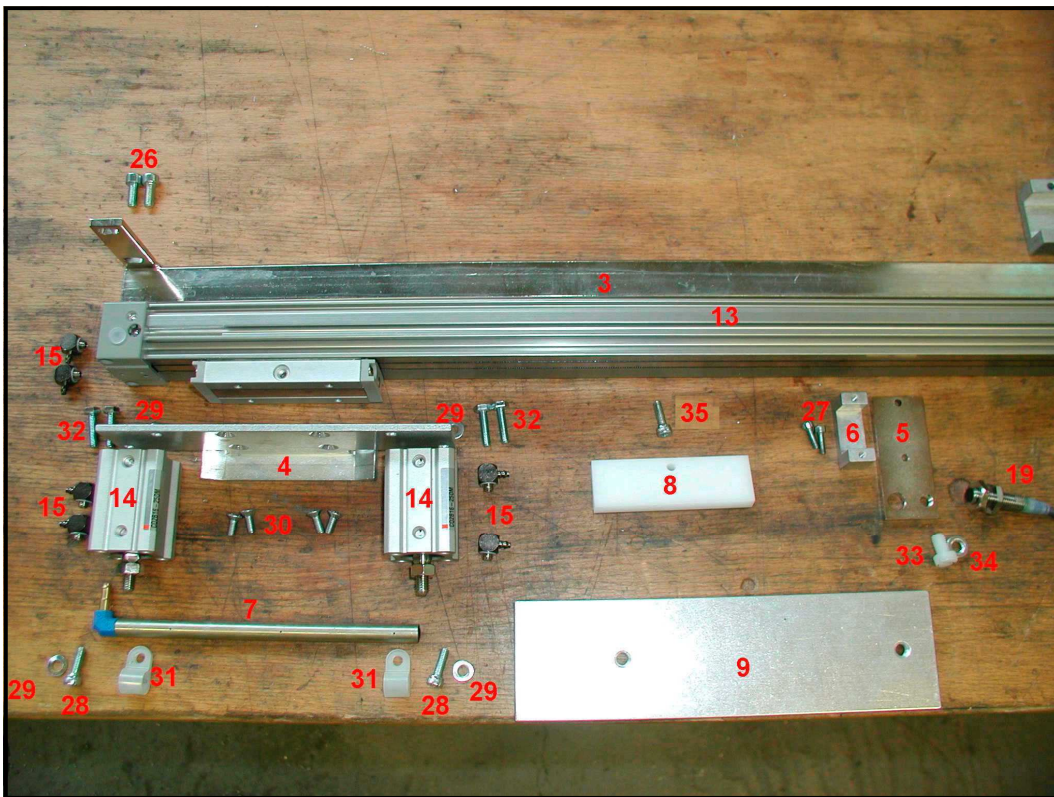
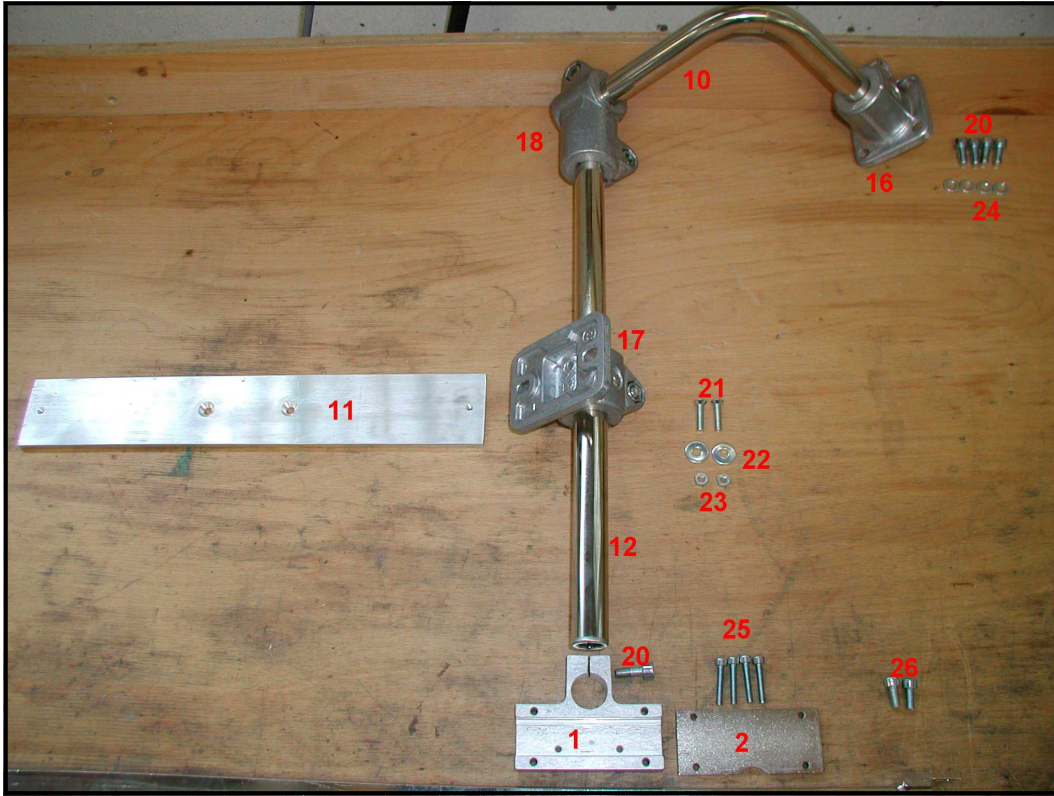

BASS 8050

Transport

Tafel 7.0

NR. NO.	ARTIKEL NR. ARTICLE NO.	BEZEICHNUNG	NAME	ST. Q'ty
1	030-0720-00	Klemme	clamp	1
2	030-0721-00	Platte	plate	1
3	030-2180-00	Zylinderhalter	cylinder holder	1
4	030-2181-00	Halter	holder	1
5	030-2184-00	Platte	plate	1
6	030-2186-00	Klemme	clamp	1
7	030-2187-00	Blasrohr	blow pipe	1
8	030-2894-00	Führungsstück	guide piece	1
9	030-2937-00	Platte	plate	1
10	030-2943-00	Winkelrohr	angle pipe	1
11	030-2952-00	Halteplatte	holding plate	1
12	030-2965-00	Rohr	pipe	1
13	040-10236-01	Zylinder	cylinder	1
14	041-16025-20	Zylinder	cylinder	2
15	044-14341-00	Verschraubung	screw joint	6
16	050-16434-00	Klemme	clamp	1
17	050-16438-00	Klemme	clamp	1
18	050-16440-00	Klemme	clamp	1
19	060-21724-00	Schalter	switch	1
20	DIN 912 M6X16	Zylinderschraube	screw	5
21	DIN 965 M5X20	Senkschraube	screw	2
22	DIN 9021 A 5,3	Scheibe	washer	2
23	DIN 934 M5	Sechskantmutter	nut	2
24	DIN 125 A 6,4	Scheibe	washer	4
25	DIN 912 M4X22	Zylinderschraube	screw	4
26	DIN 912 M5X12	Zylinderschraube	screw	4
27	DIN 912 M3X10	Zylinderschraube	screw	2
28	DIN 912 M4X12	Zylinderschraube	screw	2
29	DIN 125 A 4,2	Scheibe	washer	6
30	DIN 965 M4X10	Senkschraube	screw	4
31	HNY 4	Klemme	clamp	2
32	DIN 933 M4X16	Sechskantschraube	screw	4
33	DIN 933 M6X16	Schraube-Kunststoff	screw	1
34	DIN 439 M6	Sechskantmutter	nut	1
35	DIN 912 M4X16	Zylinderschraube	screw	1
BASS 8050		Transport		Tafel 7.0

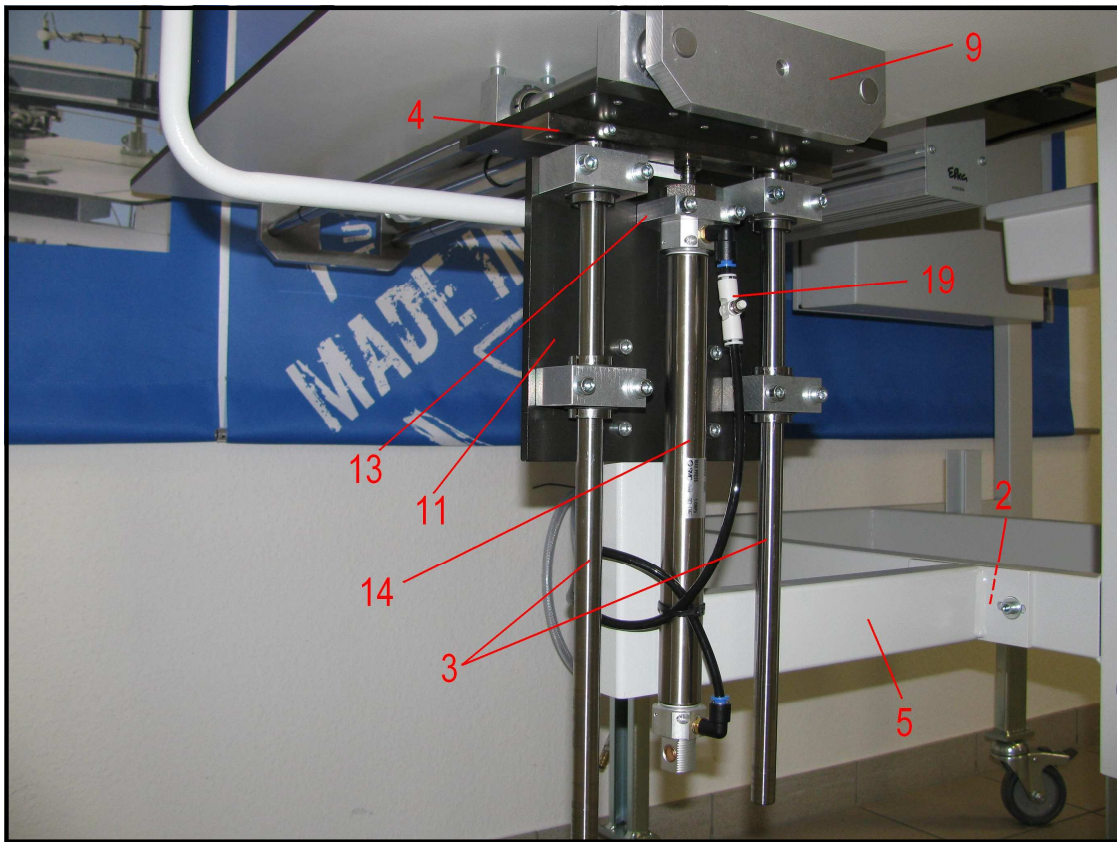
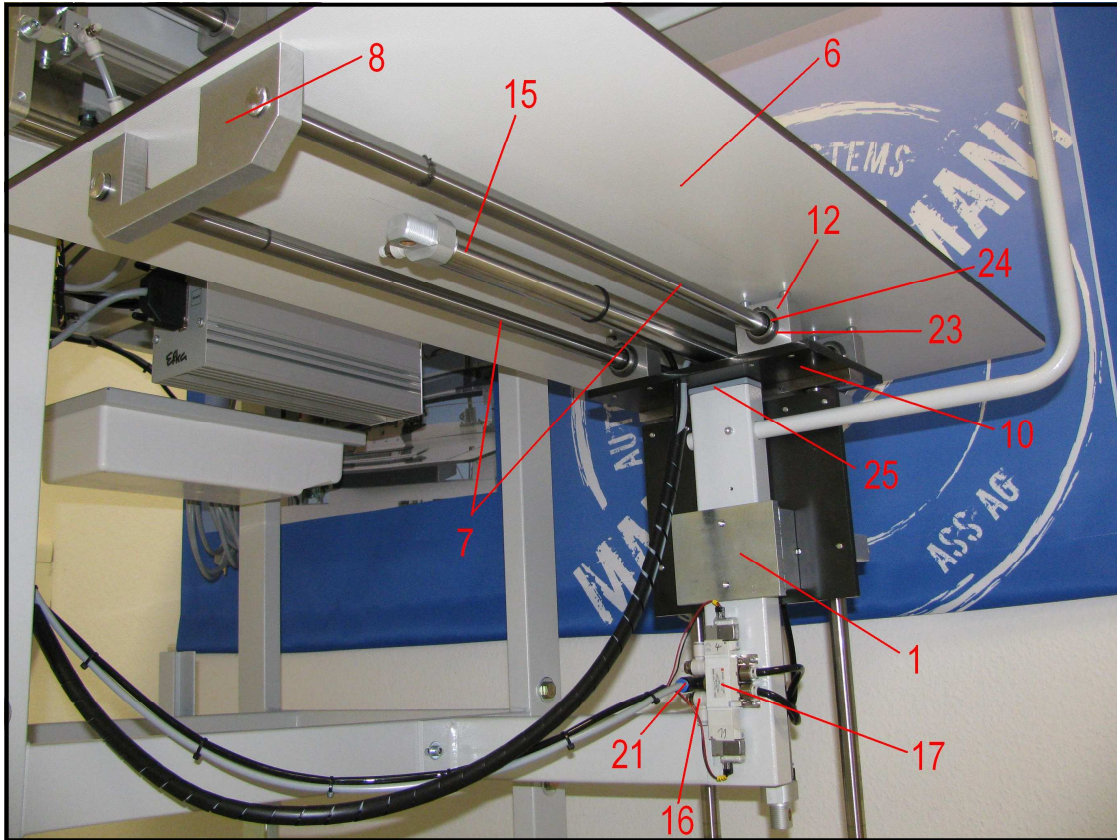

BASS 8050

Hubtisch mit Teileseparierung

Tafel 8.0

NR. NO.	ARTIKEL NR. ARTICLE NO.	BEZEICHNUNG	NAME	ST. Q`ty
1	030-0713-00	Klemmstück	clamping piece	1
2	030-2196-00	Platte	plate	1
3	030-2886-00	Welle	shaft	2
4	030-2887-00	Brücke	strap	1
5	030-2888-00	Halter	holder	1
6	030-3741-00	Ablageplatte	plate	1
7	030-3783-00	Welle	shaft	2
8	030-3784-00	Führungsplatte - vorne	guide plate - front	1
9	030-3785-00	Führungsplatte - hinten	guide plate - back	1
10	030-3786-00	Befestigungsplatte - oben	mounting plate - up	1
11	030-3787-00	Befestigungsplatte - unten	mounting plate - down	1
12	030-3788-00	Führungsstück	guide piece	8
13	030-3789-00	Zylinderhalter	cylinder holder	2
14	040-25250-21	Zylinder	cylinder	1
15	040-25400-21	Zylinder	cylinder	1
16	042-11197-00	Drossel	throttle	4
17	042-11278-00	Ventil	valve	1
19	042-11284-02	Drossel	throttle	1
21	044-13287-00	Einschraubwinkel	screw joint	1
23	050-15399-00	Sicherungsring	locking ring	16
24	050-15404-00	Kugelbuchse	ball lining	8
25	050-25873-00	Rohrkappe	sealing plug	1
BASS 8050		Hubtisch mit Teileseparierung		Tafel 8.0

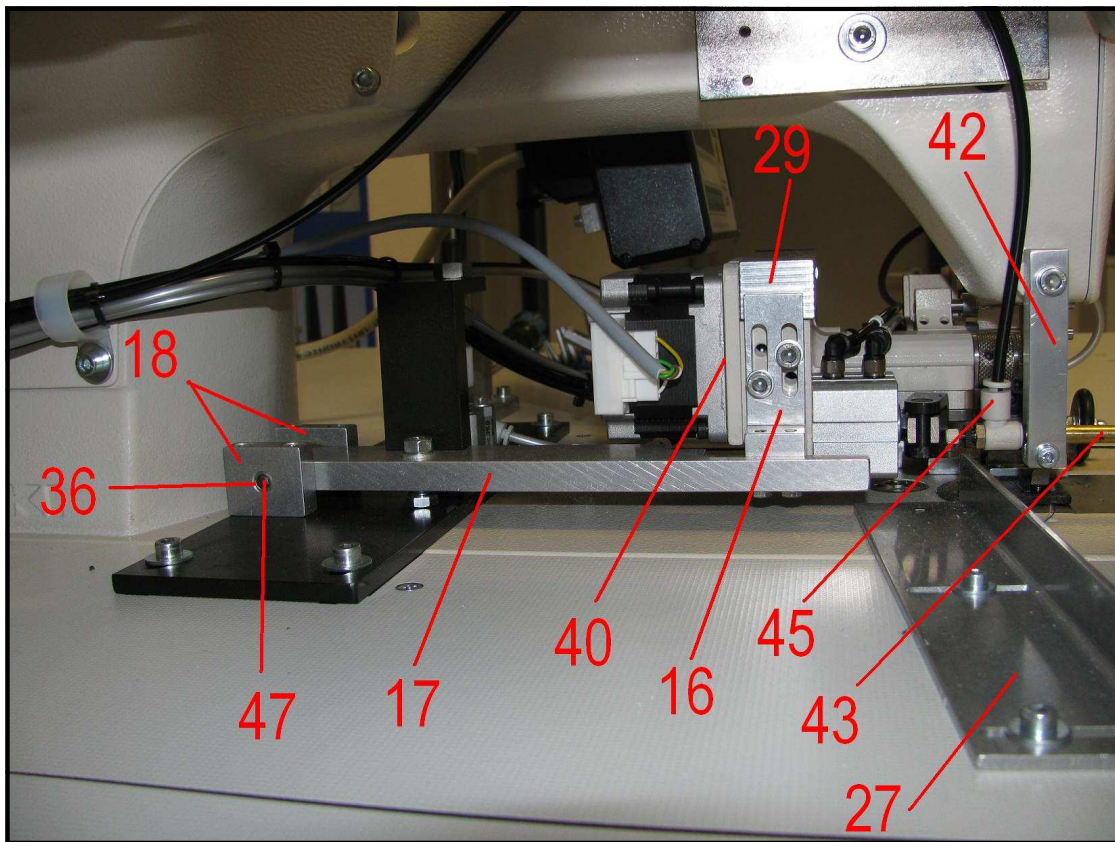
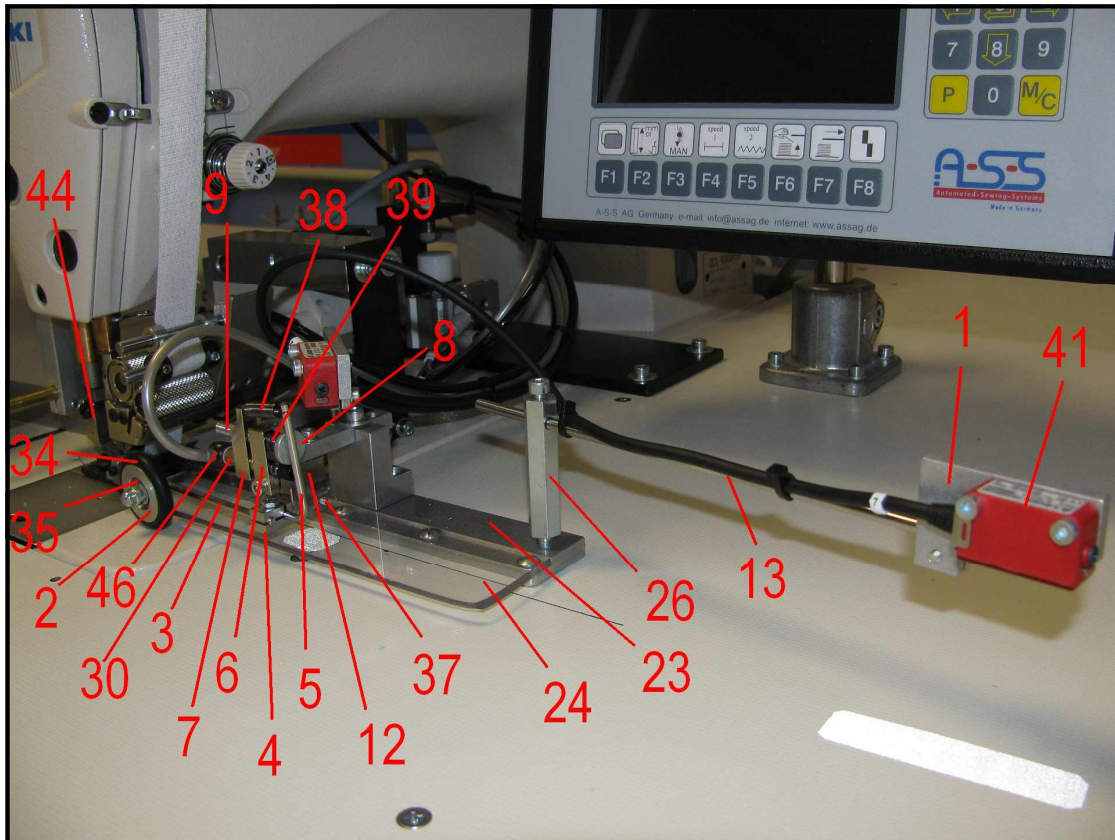

BASS 8050

Konturenführung

Tafel 9.0

NR. NO.	ARTIKEL NR. ARTICLE NO.	BEZEICHNUNG	NAME	ST. Q`ty
1	030-0036-00	Fotozellenhalter	photocell holder	2
2	030-0039-00	Rolle	sheave	1
3	030-0040-00	Rollenhalter	roll holder	1
4	030-0041-00	Klemmwelle	bar clamp	1
5	030-0042-00	Rollenhebel	roll bard	1
6	030-0043-00	Rollenhalter	roll holder	1
7	030-0044-00	Halter	holder	1
8	030-0045-00	Rändelmutter	knurled nut	1
9	030-0046-00	Stehbolzen	stay bolt	1
10	030-0278-00	Anschlagschraube	stop screw	1
11	030-0279-00	Mutter	nut	1
12	030-1173-00	Gewindebolzen	thread bolt	1
13	030-2381-00	Welle	shaft	1
14	030-3761-00	Anschlagstück	stop piece	1
15	030-3762-00	Grundplatte	base plate	1
16	030-3763-00	Haltewinkel	holding angle	1
17	030-3764-00	Schwenkleiste	pivoting ledge	1
18	030-3765-00	Wellenbock	shaft bracket	2
19	030-3797-00	Druckstück	pressure piece	1
20	030-3798-00	Verbindungsstück	connecting piece	1
21	030-3799-00	Zwischenstück	adapter	1
22	030-3800-00	Träger	bracket	1
23	030-3801-00	Führungsschiene	guard rail	1
24	030-3802-00	Führungsglas	guard glass	1
25	030-3803-00	Halter	holder	1
26	030-3804-00	Stehbolzen	stay bolt	1
27	030-3805-00	Führungswinkel	guide angle	1
28	030-3806-00	Verbindungsplatte	splice plate	1
29	030-3807-00	Trägerelement	carrier	1
30	040-10120-00	Zylinder	cylinder	1
31	041-16010-19	Zylinder	cylinder	1
32	042-06927-00	Drossel	throttle	2
34	050-11129-01	O-Ring	o-ring	1
35	050-15373-00	Kugellager	ball bearing	1
36	050-15426-00	Buchse	sleeve	3
37	050-16463-00	Stellschraube	set screw	1
38	050-17449-00	Feder	spring	1
39	050-17462-00	Druckfeder	compression spring	1
40	050-24850-00	Metering Device	metering device	1
41	060-21743-04	Fotozelle	photocell	2
42	030-3791-00	Halter für Blasrohr	holder for blowtube	1
43	030-3792-00	Blasrohr	blowtube	1
44	030-3796-00	Nähfuß	sewing foot	1
45	042-07418-00	Drossel	throttle	1
46	044-14341-00	Verschraubung	screw joint	1
47	Ø 5 x 50mm	Passtift	fixing pin	1

BASS 8050

Konturenführung

Tafel 9.0

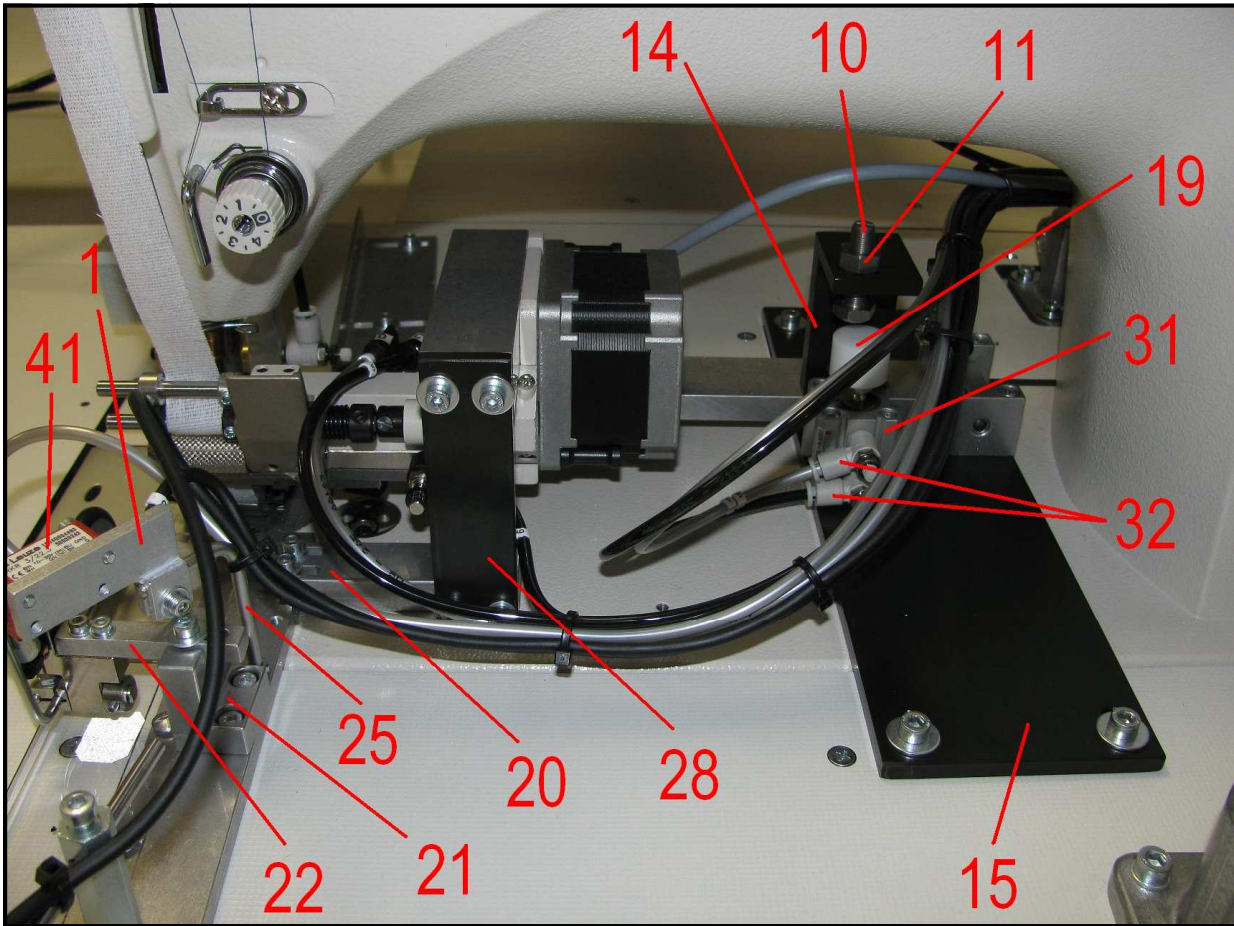

BASS 8050

Konturenführung

Tafel 9.1

NR. NO.	ARTIKEL NR. ARTICLE NO.	BEZEICHNUNG	NAME	ST. Q'ty
1	030-0036-00	Fotozellenhalter	photocell holder	2
2	030-0039-00	Rolle	sheave	1
3	030-0040-00	Rollenhalter	roll holder	1
4	030-0041-00	Klemmwelle	bar clamp	1
5	030-0042-00	Rollenhebel	roll bard	1
6	030-0043-00	Rollenhalter	roll holder	1
7	030-0044-00	Halter	holder	1
8	030-0045-00	Rändelmutter	knurled nut	1
9	030-0046-00	Stehbolzen	stay bolt	1
10	030-0278-00	Anschlagschraube	stop screw	1
11	030-0279-00	Mutter	nut	1
12	030-1173-00	Gewindebolzen	thread bolt	1
13	030-2381-00	Welle	shaft	1
14	030-3761-00	Anschlagstück	stop piece	1
15	030-3762-00	Grundplatte	base plate	1
16	030-3763-00	Haltewinkel	holding angle	1
17	030-3764-00	Schwenkleiste	pivoting ledge	1
18	030-3765-00	Wellenbock	shaft bracket	2
19	030-3797-00	Druckstück	pressure piece	1
20	030-3798-00	Verbindungsstück	connecting piece	1
21	030-3799-00	Zwischenstück	adapter	1
22	030-3800-00	Träger	bracket	1
23	030-3801-00	Führungsschiene	guard rail	1
24	030-3802-00	Führungsglas	guard glass	1
25	030-3803-00	Halter	holder	1
26	030-3804-00	Stehbolzen	stay bolt	1
27	030-3805-00	Führungswinkel	guide angle	1
28	030-3806-00	Verbindungsplatte	splice plate	1
29	030-3807-00	Trägerelement	carrier	1
30	040-10120-00	Zylinder	cylinder	1
31	041-16010-19	Zylinder	cylinder	1
32	042-06927-00	Drossel	throttle	2
34	050-11129-01	O-Ring	o-ring	1
35	050-15373-00	Kugellager	ball bearing	1
36	050-15426-00	Buchse	sleeve	3
37	050-16463-00	Stellschraube	set screw	1
38	050-17449-00	Feder	spring	1
39	050-17462-00	Druckfeder	compression spring	1
40	050-24850-00	Metering Device	metering device	1
41	060-21743-04	Fotozelle	photocell	2
42	030-3791-00	Halter für Blasrohr	holder for blowtube	1
43	030-3792-00	Blasrohr	blowtube	1
44	030-3796-00	Nähfuß	sewing foot	1
45	042-07418-00	Drossel	throttle	1
46	044-14341-00	Verschraubung	screw joint	1
47	Ø 5 x 50mm	Passtift	fixing pin	1

BASS 8050

Konturenführung

Tafel 9.1