

TC6040

INSTRUCTION BOOK



ELECTRONIC PATTERN SEWING MACHINE



TYPICAL



SAFETY INSTRUCTIONS

[1] Safety indications and their meanings

This instruction manual and the indications and symbols that are used on the machine itself are provided in order to ensure safe operation of this machine and to prevent accidents and injury to yourself or other people.

The meanings of these indications and symbols are given below.

Indications

 DANGER	The instructions which follow this term indicate situations where failure to follow the instructions will result in death or serious injury.
 CAUTION	The instructions which follow this term indicate situations where failure to follow the instructions could cause injury when using the machine or physical damage to equipment and surroundings.

Symbols



..... This symbol () indicates something that you should be careful of. The picture inside the triangle indicates the nature of the caution that must be taken.
(For example, the symbol at left means “beware of injury”.)



..... This symbol () indicates something that you must not do.



..... This symbol () indicates something that you must do. The picture inside the circle indicates the nature of the thing that must be done.
(For example, the symbol at left means “you must make the ground connection”.)

[2] Notes on safety

DANGER



Wait at least 5 minutes after turning off the power switch and disconnecting the power cord from the wall outlet before opening the cover of the control box. Touching areas where high voltages are present can result in severe injury.

CAUTION

Environmental requirements



Use the sewing machine in an area which is free from sources of strong electrical noise such as electrical line noise or static electric noise. Sources of strong electrical noise may cause problems with correct operation.



Any fluctuations in the power supply voltage should be within $\pm 10\%$ of the rated voltage for the machine. Voltage fluctuations which are greater than this may cause problems with correct operation.



The power supply capacity should be greater than the requirements for the sewing machine's power consumption. Insufficient power supply capacity may cause problems with correct operation.



The pneumatic delivery capability should be greater than the requirements for the sewing machine's total air consumption. Insufficient pneumatic delivery capability may cause problems with correct operation.



The ambient temperature should be within the range of 5°C to 35°C during use. Temperatures which are lower or higher than this may cause problems with correct operation.



The relative humidity should be within the range of 45% to 85% during use, and no dew formation should occur in any devices. Excessively dry or humid environments and dew formation may cause problems with correct operation.



In the event of an electrical storm, turn off the power and disconnect the power cord from the wall outlet. Lightning may cause problems with correct operation.

Installation



Machine installation should only be carried out by a qualified technician.



Contact your Brother dealer or a qualified electrician for any electrical work that may need to be done.



The sewing machine weighs approximately 160 kg. Use equipment such as a crane or hoist when installing the machine head and adjusting the height of the table. If you try to lift the machine head yourself, it may cause injuries such as back injury.



Do not connect the power cord until installation is complete. If the foot switch is depressed by mistake, the sewing machine might start operating and injury could result.



Hold the machine head with both hands when tilting it back or returning it to its original position. In addition, do not subject the machine head to extra force while it is tilted back. If this is not observed, the machine head may become unbalanced and fall down, and serious injury or damage to the sewing machine may result.



Be sure to connect the ground. If the ground connection is not secure, you run a high risk of receiving a serious electric shock, and problems with correct operation may also occur.



All cords should be secured at least 25 mm away from any moving parts. Furthermore, do not excessively bend the cords or secure them too firmly with staples, otherwise there is the danger that fire or electric shocks could occur.



Install the safety covers to the machine head and motor.



If using a work table which has casters, the casters should be secured in such a way so that they cannot move.











Use a table with a height of 84 cm or less. If the table is too high, the machine head may become unbalanced and fall down, and serious injury or damage to the sewing machine may result.





Be sure to wear protective goggles and gloves when handling the lubricating oil and grease, so that they do not get into your eyes or onto your skin. If the oil and grease get into your eyes or onto your skin, inflammation can result. Furthermore, do not drink or eat the lubricating oil or grease. They may cause diarrhea or vomiting. Keep the oil out of the reach of children.

CAUTION









Sewing

-  This sewing machine should only be used by operators who have received the necessary training in safe use beforehand.
-  The sewing machine should not be used for any applications other than sewing.
-  Be sure to wear protective goggles when using the machine.
If goggles are not worn, there is the danger that if a needle breaks, parts of the broken needle may enter your eyes and injury may result.
-  Turn off the power switch at the following times. If the foot switch is depressed by mistake, the sewing machine might start operating and injury could result.
 - When threading the needle
 - When replacing the bobbin and needle
 - When not using the machine and when leaving the machine unattended
-  If using a work table which has casters, the casters should be secured in such a way so that they cannot move.
-  Attach all safety devices before using the sewing machine. If the machine is used without these devices attached, injury may result.
-  Do not touch any of the moving parts or press any objects against the machine while sewing, as this may result in personal injury or damage to the machine.
-  If an error occurs in machine operation, or if abnormal noises or smells are noticed, immediately turn off the power switch. Then contact your nearest Brother dealer or a qualified technician.
-  If the machine develops a problem, contact your nearest Brother dealer or a qualified technician.

Cleaning

-  Turn off the power switch before carrying out cleaning. If the foot switch is depressed by mistake, the sewing machine might start operating and injury could result.
-  Be sure to wear protective goggles and gloves when handling the lubricating oil and grease, so that they do not get into your eyes or onto your skin. If the oil and grease get into your eyes or onto your skin, inflammation can result.
Furthermore, do not drink or eat the lubricating oil or grease. They may cause diarrhea or vomiting.
Keep the oil out of the reach of children.

Maintenance and inspection

-  Maintenance and inspection of the sewing machine should only be carried out by a qualified technician.
-  Ask your Brother dealer or a qualified electrician to carry out any maintenance and inspection of the electrical system.
-  Turn off the power switch and disconnect the power cord before carrying out the following operations. If the foot switch is depressed by mistake, the sewing machine might start operating and injury could result.
 - Inspection, adjustment and maintenance
 - Replacing consumable parts such as the rotary hook
-  Disconnect the air hoses from the air supply and wait for the needle on the pressure gauge to drop to "0" before carrying out inspection, adjustment and repair of any parts which use the pneumatic equipment.
-  Hold the machine head with both hands when tilting it back or returning it to its original position.
In addition, do not subject the machine head to extra force while it is tilted back. If this is not observed, the machine head may become unbalanced and fall down, and serious injury or damage to the sewing machine may result.
-  If the power switch and air need to be left on when carrying out some adjustment, be extremely careful to observe all safety precautions.
-  Use only the proper replacement parts as specified.
-  If any safety devices have been removed, be absolutely sure to re-install them to their original positions and check that they operate correctly before using the machine.
-  Any problems in machine operation which result from unauthorized modifications to the machine will not be covered by the warranty.

[3] Warning labels

The following warning labels appear on the sewing machine.

Please follow the instructions on the labels at all times when using the machine. If the labels have been removed or are difficult to read, please contact your nearest dealer.

1

	⚠ 危険 ⚠ 危険	
	高電圧部分にふれて、大けがをすることがある。電源を切り、5分たってからカバーをはずすこと。	触摸高压电部分，会导致受伤。在切断电源5分钟后，再开启盖罩。
⚠ DANGER	⚠ GEFAHR	⚠ DANGER ⚠ PELIGRO
Hazardous voltage will cause injury. Turn off main switch and wait 5 minutes before opening this cover.	Hochspannung verletzungsgefahr! Bitte schalten sie den Hauptschalter aus und warten sie 5 minuten, bevor sie diese abdeckung öffnen.	Un voltage non adapte provoque ces blessures. Eteindre l'interrupteur et attendre 5 minutes avant d'ouvrir le capot.
		Un voltaje inadecuado puede provocar las heridas. Apagar el interruptor principal y esperar 5 minutos antes de abrir esta cubierta.

2

	⚠ 注意
	触摸运动部分，易造成受伤。所以在装上安全保护装置后，再进行缝纫操作。在切断电源后，进行穿线，更换梭芯，机针和做清扫，调整工作。
⚠ CAUTION	
Moving parts may cause injury. Operate with safety devices. Turn off main switch before threading, changing bobbin and needle, cleaning etc.	

3  Be careful to avoid getting hands caught in sliding parts.

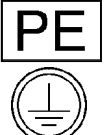
4  Be sure to connect the ground. If the ground connection is not secure, you run a high risk of receiving a serious electric shock, and problems with correct operation may also occur.

5  Direction of operation

Safety devices:

Devices such as eye guard, finger guard, thread take-up cover, motor cover, X motor cover, tension release solenoid cover, inside cover, outside cover, middle cover, fixed cover and rear cover

CONTENTS

1. Major Parts.....	1
2. Specifications.....	2
3. Installation Methods.....	3
3.1 Removing the machine head fixing bolts.....	3
3.2 Installing the electric control box.....	4
3.3 Installing the oil pan and support lever base.....	5
3.4 Installing the machine head.....	5
3.5 Tilting back and returning the machine head.....	6
3.6 Installing the eye guard.....	7
3.7 Installing the cotton stand.....	7
3.8 Lubrication.....	8
4. Preparation before Sewing.....	9
4.1 Installing the needle.....	9
4.2 Operating the foot switch	9
4.3 Threading the upper thread	10
4.4 Winding the lower thread.....	12
4.5 Installing the bobbin case.....	13
4.6 Thread tension.....	14
4.6.1 Lower thread tension.....	14
4.6.2 Upper thread tension.....	14
4.7 Home position detection.....	15
5. Operating the touch screen	16
6. Sewing.....	47
6.1 Sewing method.....	47
6.2 Using the STOP switch.....	48
6.3 Using the thread wiper switch.....	48
7. Maintenance.....	49
7.1 Cleaning the rotary hook	49
7.2 Draining waste oil.....	49
7.3 Checking the regulator.....	50
7.3 Cleaning the control box air inlet ports.....	50
7.4 Cleaning the eye guard.....	50
7.5 Checking the needle.....	50

8. Standard Adjustments.....	51
8.1 Adjusting the thread take-up spring.....	51
8.2 Adjust arm thread guide R.....	52
8.3 Adjusting the needle bar height.....	52
8.4 Adjusting of the position of needle and spindle.....	52
8.5 Adjusting the driver needle guard.....	53
8.6 Adjusting the needle clearance.....	53
8.7 Adjusting the shuttle race thread guide.....	53
8.8 Adjusting the rotary hook lubrication amount.....	54
8.9 Adjusting the position of the movable knife.....	55
8.10 Adjusting the thread wiper.....	57
8.11 Pressor foot installation position.....	57
9. Table of error codes.....	58
10. Troubleshooting.....	62

1. Major Parts

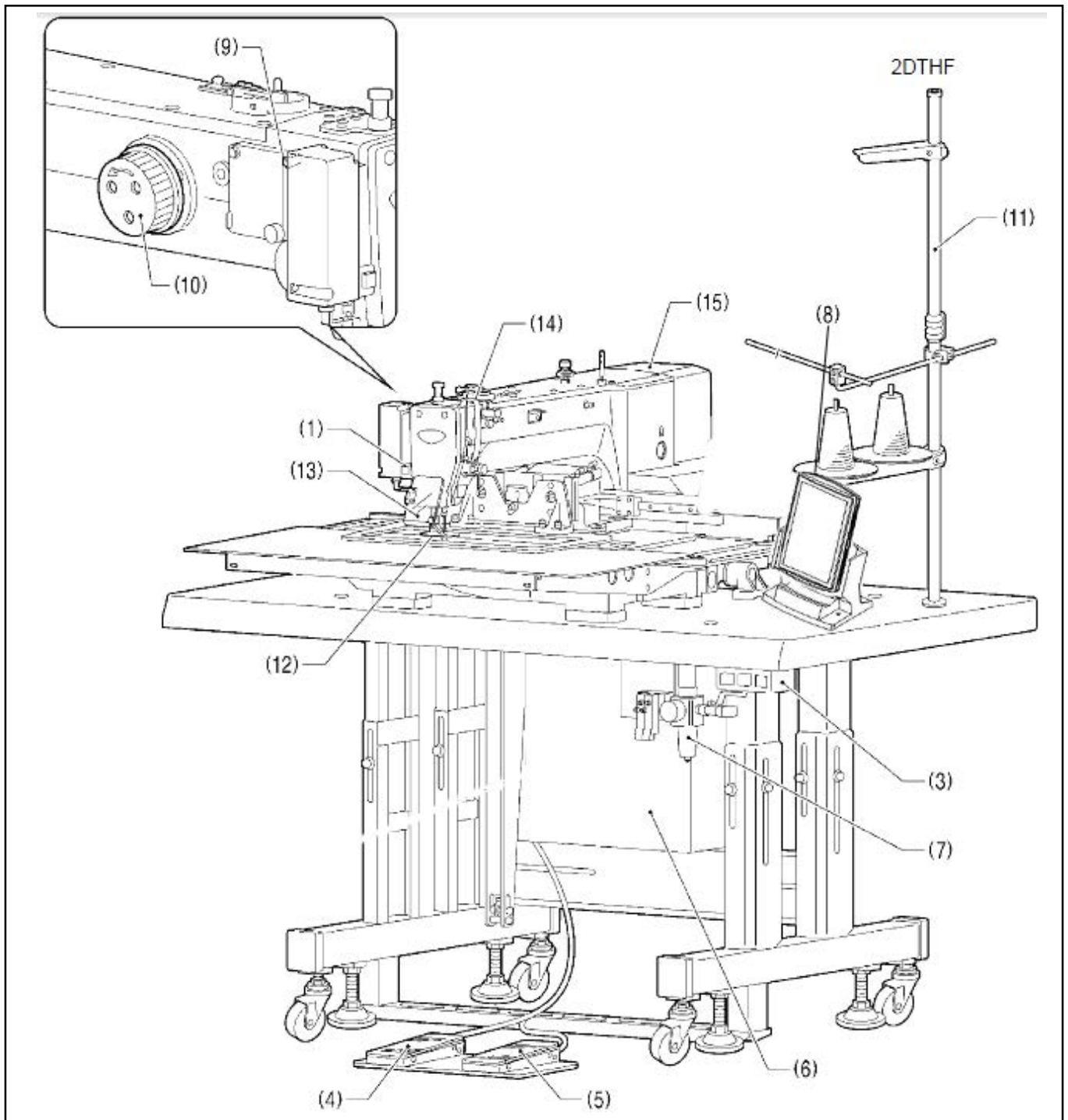

- (1) STOP switch
- (3) Power switch
- (4) Work clamp switch
- (5) Start switch
- (6) Control box
- (7) solenoid valve
- (8) Touch screen
- (9) Thread wiper switch

- (10) Pulley
- (11) Cotton stand

Safety devices:





- (12) Finger guard
- (13) Eye guard
- (14) Thread take-up cover
- (15) Motor cover

2. Model

Model	SP-6040AS-M
Line	Sing-needle flat seam
Highest sewing speed	2700rpm
Sewing area	Max. 4530×300mm
Cloth feeding mode	Intermittent feeding(Servo motor drive mode)
Stitch Length	0.05-12.7mm
Maximum stitch amount	20,000 needles/1 pattern
Storage amount of stitches	Maximum 500000stitch in inner storage
Presser foot drive method	Pneumatic
Press foot height	Max. 30mm
2- step presser foot	All-in-one presser foot
Big foot presser height	Max. 30mm
Big foot presser method	All-in-one presser foot
Rising amount of intermittent foot presser	22mm
Stroke by intermittent presser foot	0 or 2-10mm (Factory defaults: 3mm)
Thread Wiper	Standard facility
Cutting device	Standard facility
Motor	AC servomotor 550W
Power	Single phase200~240V
Air pressure	0.5Mpa、1.8L/min

3. Installation Methods

CAUTION

-  Installation should be performed by well-trained technicians.
-  Please entrust the dealer or a qualified electrician to carry out the electric wiring.
-  **he` sewing machine weighs XXX kg.**
Please use a crane to mount the sewing machine and adjust the height of the worktop.
If handled by workers, it would be easy to cause low back pain and injuries.
-  Do not connect the power cord until installation is complete.
If the foot switch is depressed by mistake, the sewing machine might start operating and injury could result.
-  If using a work table which has casters, the casters should be secured in such a way so that they cannot move.

 Use a table with a height of XX cm or less. If the table is too high, the machine head may become unbalanced and fall down, which would result in serious injury or damage to the sewing machine.

 Hold the machine head with both hands when tilting it back or returning it to its original position.
In addition, do not subject the machine head to extra force while it is tilted back. If this is not observed, the machine head may become unbalanced and fall down, which would result in serious injury or damage to the sewing machine.

 All cables should be placed at least 25mm away from the movable part. Additionally, don't overbend the cable or fix it too tight with clips, which may cause fire or electric shock; The machine must be grounded.

 Unsecured grounding may result in electric shock or false operation.

 Install the safety covers to the machine head and motor.

3.1 Removing the machine head fixing bolts

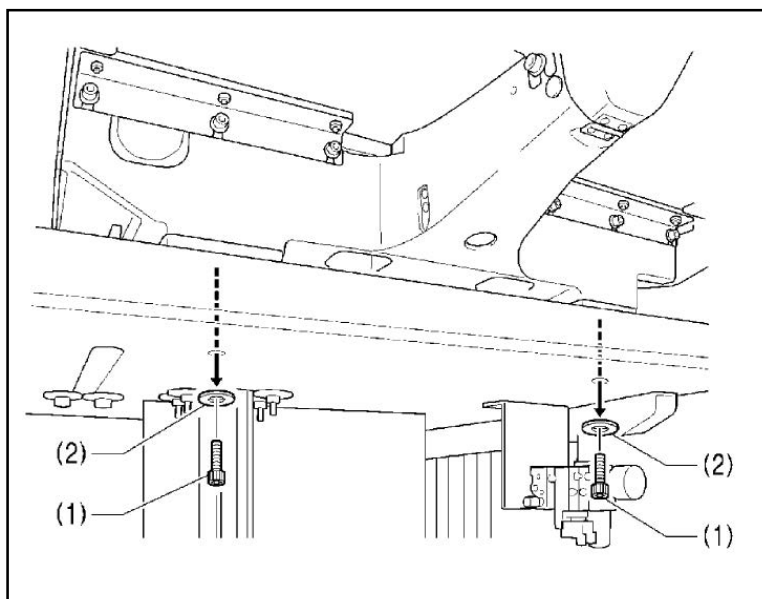

If the sewing machine was already installed to the table when it was delivered, remove the two machine head fixing bolts (1) [2 pcs] and the two plain washers (2) [2 pcs].

3.2 Installing the electric control box



CAUTION



Installation should be performed by two people or more since the control box is heavy. Also, please don't let the control box slip down. It may hurt your feet and cause the control box to malfunction.

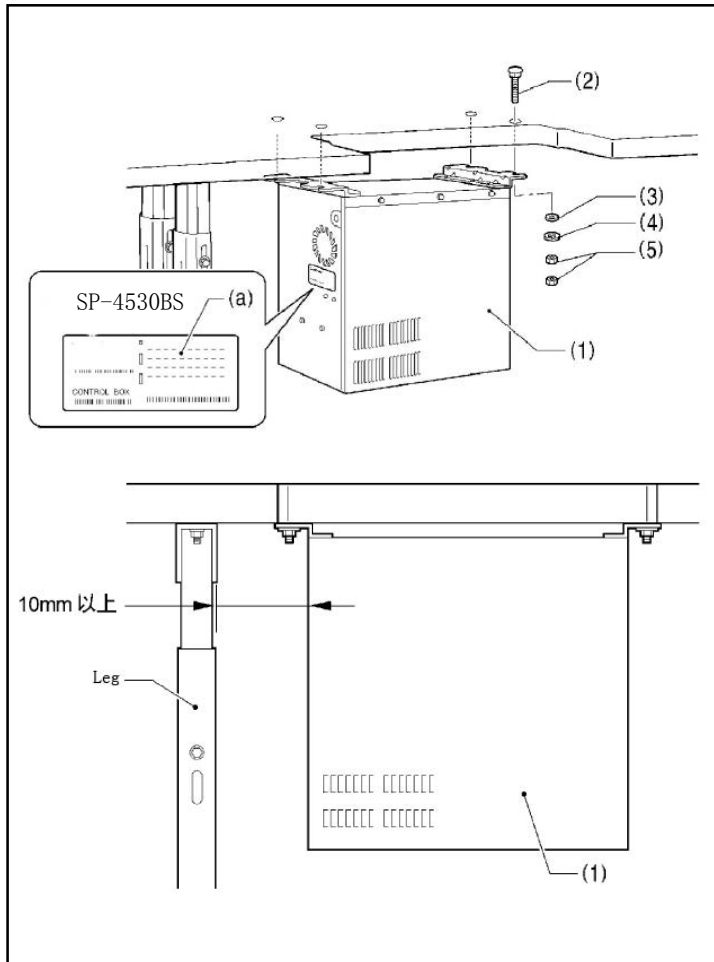

Before installation, please confirm the model name on the nameplate (a) of the control box (1) and the electric control box used by the sewing machine SP-4530BS.

Tilt the machine head if the sewing machine

* has already been installed to the table.

- (1) Control box
- (2) Bolts [4 pcs.]
- (3) Plain washers [4 pcs.]
- (4) Spring washers [4 pcs.]
- (5) Nuts [8 pcs.]

[Note]

Check that the control box (1) is at least 10mm away from the leg of the table. If the control box (1) is too close to the leg, it may cause the sewing machine to malfunction.

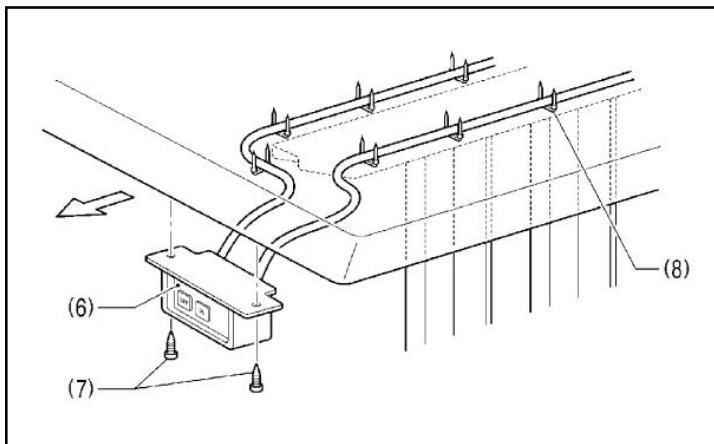

- (6) Power switch
- (7) Wood screws [2 pcs.]

3.3. Installing the oil pan and support lever base

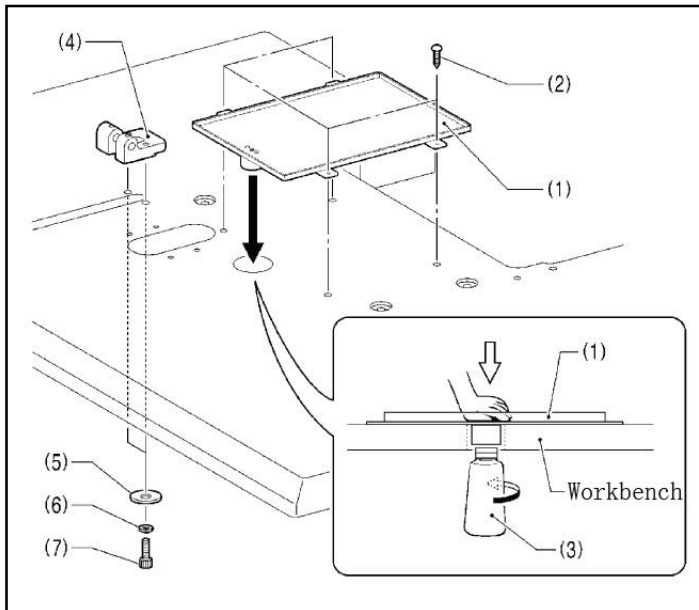

- (1) Oil pan
- (2) Wood screws [4 pcs.]
- (3) Oiler
- (4) Support lever base
- (5) Plain washers [2 pcs.]
- (6) Spring washers [2 pcs.]
- (7) Bolts [2 pcs.]

3.4. Installing the machine head

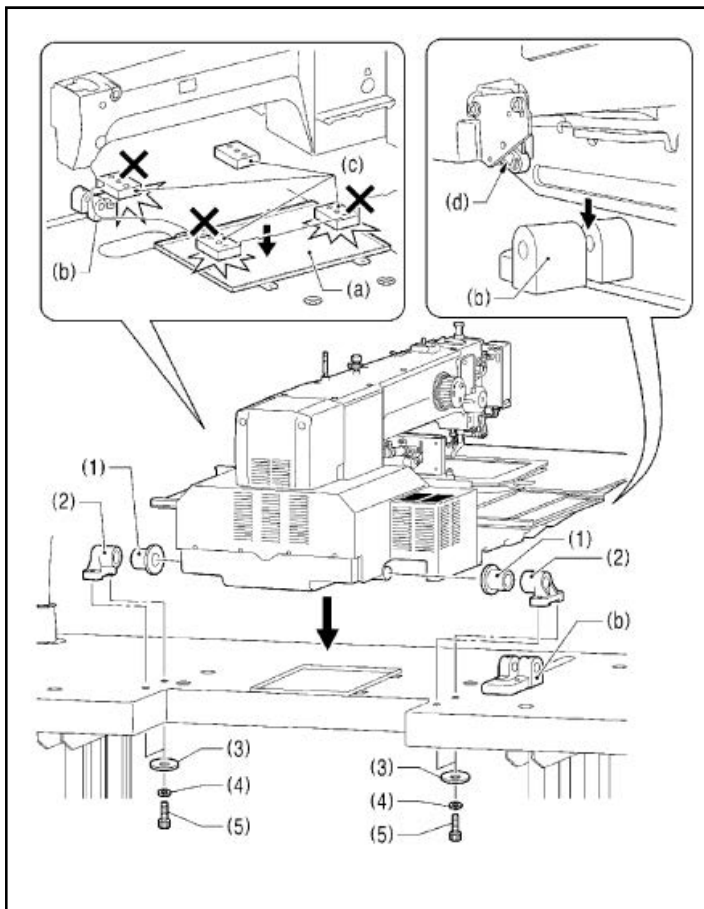

1. Place the machine head onto the table.

[Note]

- Use a crane or hoist to install the sewing machine.
- Be careful of the following when lowering the machine head onto the table.
 - ! Do not let any cords get clamped between the machine head and the table.
 - ! Do not place the machine head cushion (c) on top of the oil pan (a) or the support lever base (b).
 - ! Do not let the side (d) of the safety switch lever touch the support lever base (b).

- (1) Rubber bushes [2 pcs.]
- (2) Hinge holders [2 pcs.]
- (3) Plain washers [4 pcs.]
- (4) Spring washers [4 pcs.]
- (5) Bolts [4 pcs.]

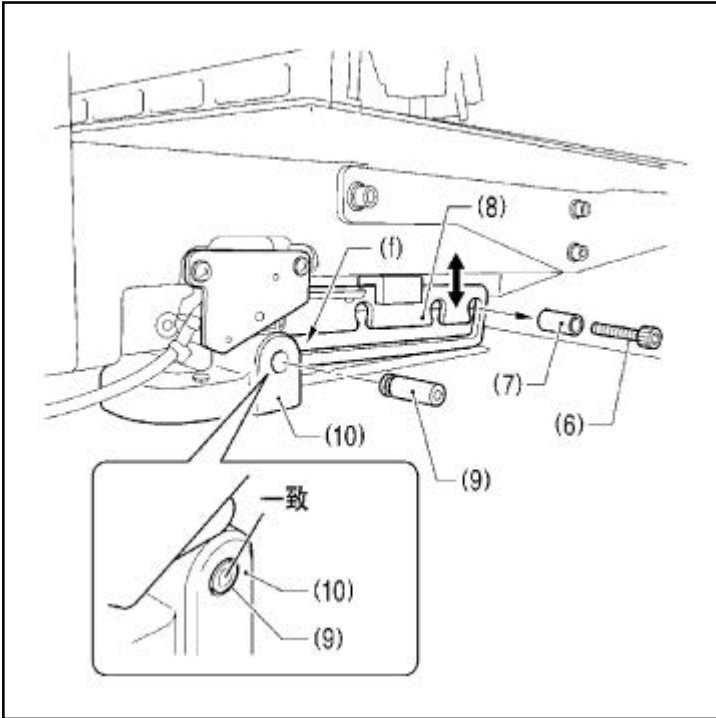

2. After placing the machine head onto the table, remove the bolt (6) and the spacer (7).
 - * The bolt (6) and the spacer (7) are necessary for securing the support lever (8) when the machine head is removed from the table, so keep them in a safe place.
3. Pass the support lever shaft (9) through the hole in the support lever base (10) and through the groove (f) in the support lever (8), and push it in until it is flush with the surface of the support lever base (10).
 - * If it is difficult to pass the support lever shaft (9) through the groove (f) in the support lever (8), move the end of the support lever (8) up and down while passing the support lever shaft (9) through.

3.5 Tilting back and returning the machine head



CAUTION



Hold the machine head with both hands when tilting it back or returning it to its original position. In addition, do not subject the machine head to extra force while it is tilted back. If this is not observed, the machine head may become unbalanced and fall down, which would result in serious injury or damage to the sewing machine.



Always be sure to engage the stopper of the support lever (1) when tilting back the machine head.

If the stopper is not engaged, the machine head may return to its original position and your hands may get caught and injury may result.



When disengaging the stopper, hold it by the knob (a). If you hold at the place indicated by (b), your hand will get caught between the support lever (1) and the table when the machine head is returned to its original position and injury will result.

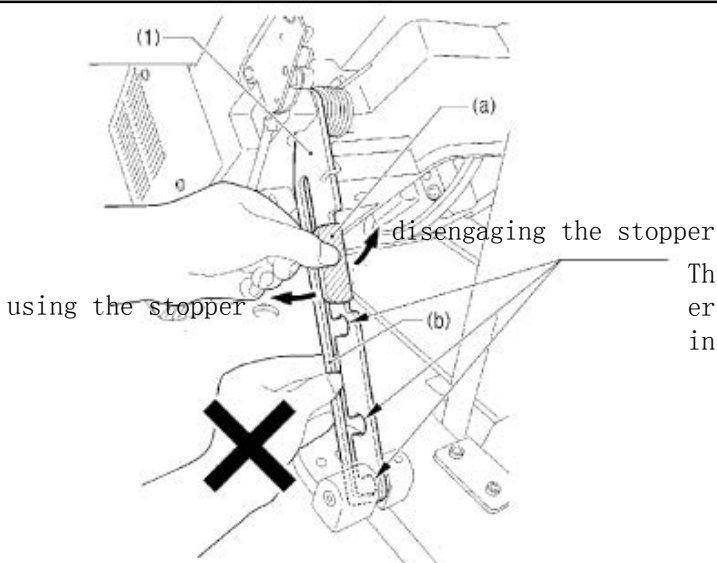

The head of a sewing machine falls down or erected. It can be broken down or erected in three stalls.

3.6. Installing the eye guard



CAUTION



Attach all safety devices before using the sewing machine.

If the machine is used without these devices attached, injury may result.

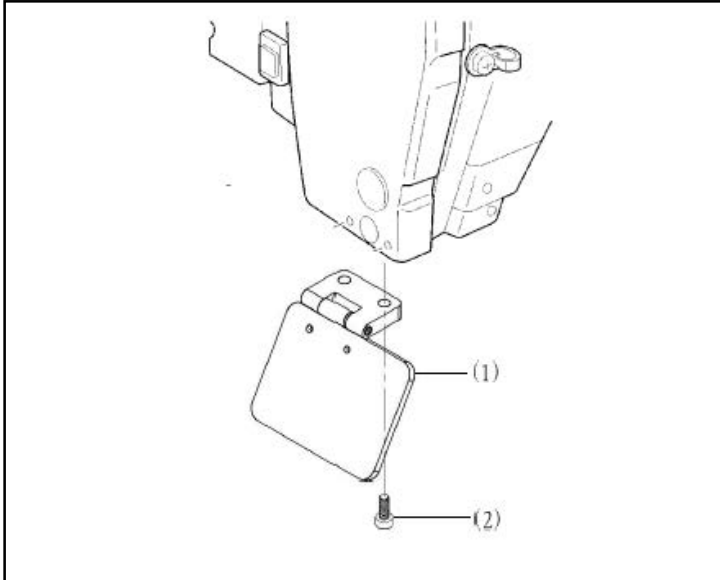

- (1) Eye guard assembly
- (2) Screws [2 pcs.]

3.7 Installing the cotton stand

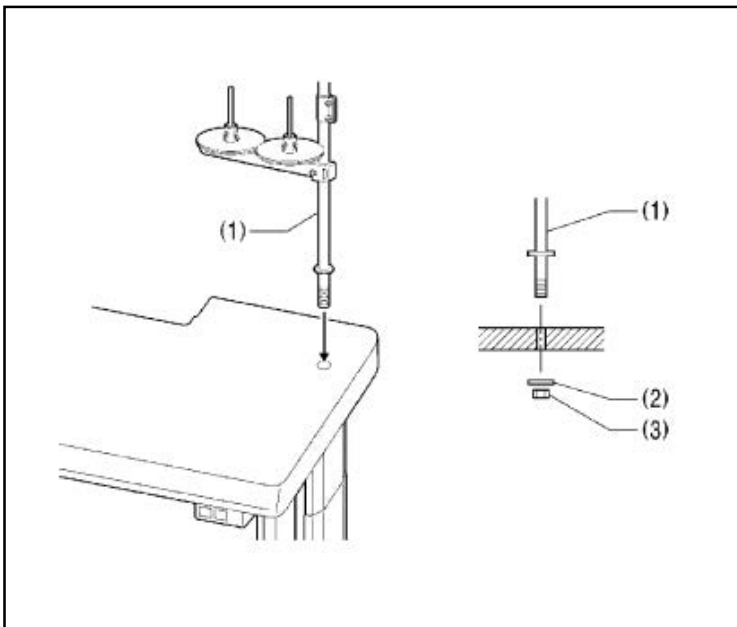

- (1) Thread stand

[NOTE]

Fit the washer (2), and then securely tighten the nut (3) so that the cotton stand does not move.

3.8 Lubrication



CAUTION



Do not connect the power cord until lubrication is complete.

If the foot switch is depressed by mistake, the sewing machine might start operating and injury could result.

Be sure to wear protective goggles and gloves when handling the lubricating oil and grease, so that they do not get into your eyes or onto your skin. Otherwise, inflammation can result.



Furthermore, do not drink or eat the lubricating oil or grease, which may cause diarrhea or vomiting.

Keep the oil out of the reach of children.

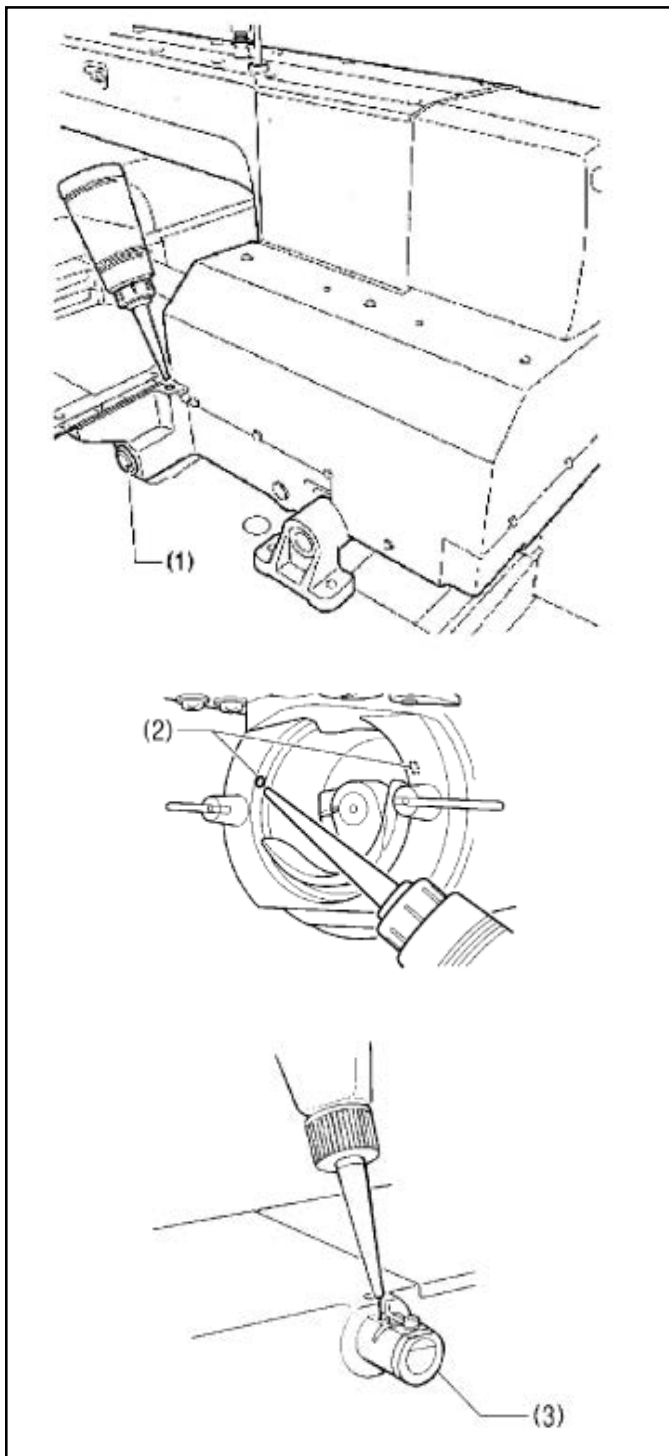

- The sewing machine should always be lubricated and the oil supply replenished before it is used for the first time, and also after long periods of non-use.

- Use only the lubricating oil specified by the Company.

1. Fill the arm oil tank and the bed oil tank with oil.

[NOTE]

Be sure to fill the machine with oil when the oil level is down to about one-third full in the oil sight glass (1). If the oil drops below the one-third level of the oil sight glass (1), there is the danger of malfunction due to the burn of machine.

2. Pour oil in through the two holes (2) of the shuttle race base assembly so that the felt is lightly moistened.

[NOTE]

If there is no more oil on the felt of the shuttle race base assembly, problems with sewing may result.

3. If using the needle cooler (3), fill it with silicon oil (100mm²/s).

4. Preparation before Sewing

4.1. Installing the needle



CAUTION



Turn off the power switch before installing the needle.
If the foot switch is depressed by mistake, the sewing machine might start operating and injury could result.

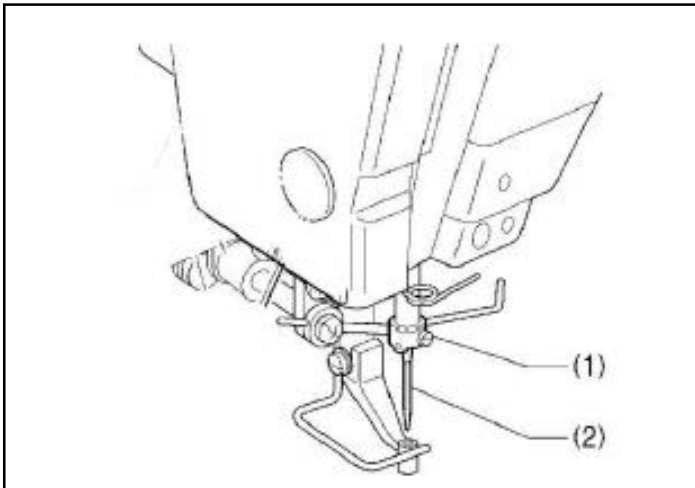

1. Loosen the screw (1).
2. Insert the needle (2) in a straight line as far as it will go, making sure that the long groove on the needle is at the front, and then securely tighten the set screw (1).

4.2. Operating the pedal foot switch

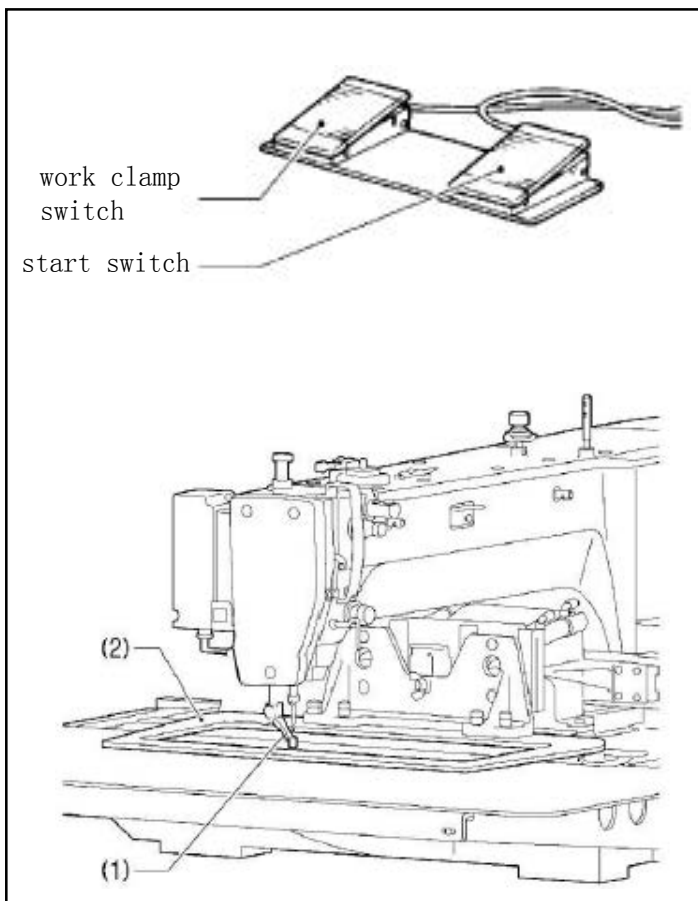

When the work clamp switch (left side) is depressed, the intermittent presser foot (1) and the work clamp (2) are lowered, and when the start switch (right side) is then depressed, the sewing machine starts operating.

* The work clamp (2) lowering method can be changed using memory switch No. 002.

4.3. Threading the upper thread

Thread the upper thread correctly as shown in the illustration below.

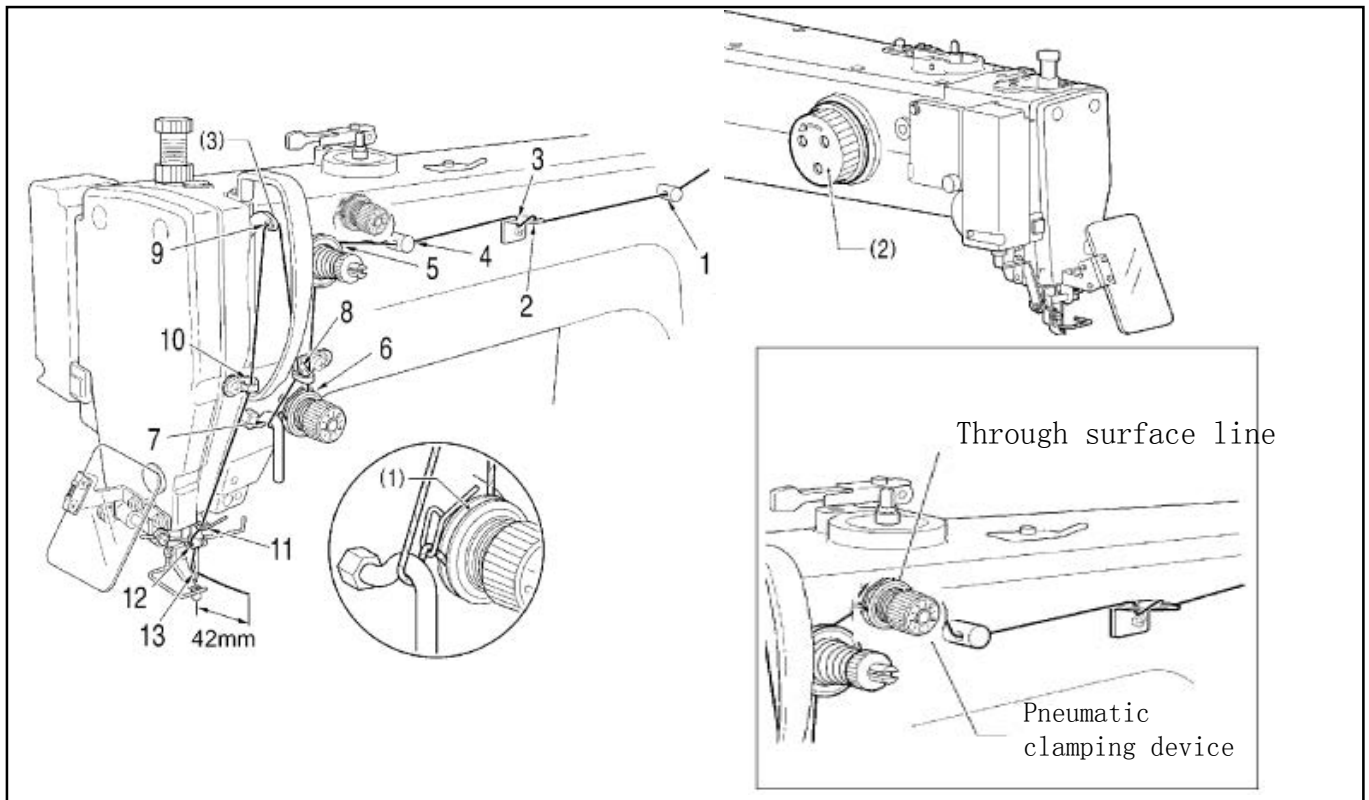

*When using threading mode for threading, the tension discs (1) will open so that the thread can be threaded more easily.



- Turn the machine pulley (2) and raise the thread take-up (3) to its highest position before threading the upper thread. (This will make threading easier and it will prevent the thread from coming out at the sewing start.)
- When threading the thread through the needle, allow a distance of approximately 42mm between the needle hole and the end of the thread.
If the trailing length of the thread is too long, it may cause the thread to become tangled.

<Threading mode>

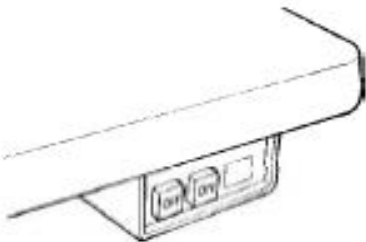
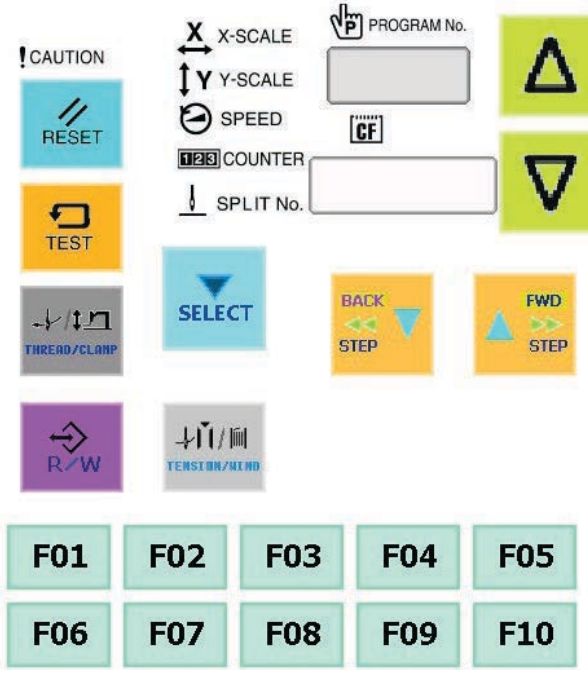
Threading mode is safe because the sewing machine will not start even when the foot switch is depressed.

1	 <p>Turn on the power switch.</p>
2	<p>Press the THREAD/CLAMP key.</p>  <ul style="list-style-type: none"> • Lower the work clamp. • The tension discs will open.
3	<p>Threading the thread</p> <ul style="list-style-type: none"> • When 5 minutes have passed, the buzzer will sound and the tension discs will close.
4	<p>Ending threading mode</p>  <p>Press the THREAD/CLAMP key.</p> <ul style="list-style-type: none"> • The work clamp will return to where it was before threading mode was started.

4.4. Winding the lower thread



Do not touch any of the moving parts or press any objects against the machine while winding the lower thread. Injury or damage to the sewing machine may result.

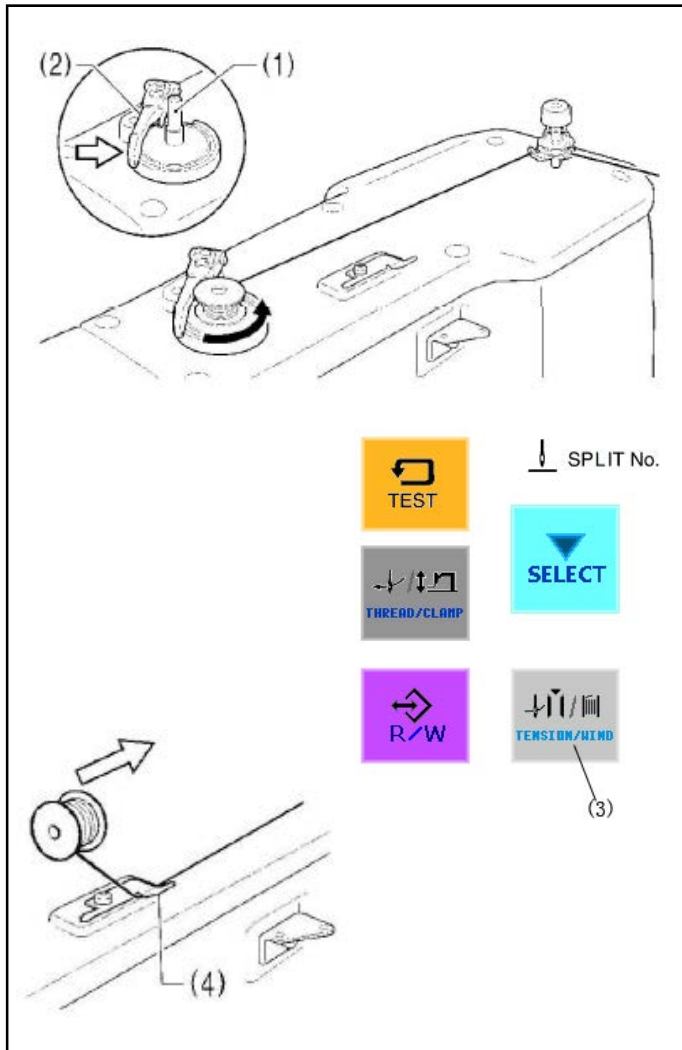

1. Place the bobbin onto the bobbin winder shaft (1).
2. Thread the thread as shown in the illustration, wind the thread around the bobbin several times, and then press the bobbin presser arm (2).
3. Turn on the power switch.
4. Depress the foot switch to the 2nd step.
(If using a two-pedal foot switch, lower the work clamp before depressing the start switch.)
Check the home position.
5. Check that the needle does not touch the work clamp, and then while pressing the TENSION/WIND key (3), depress the foot switch to the 2nd step.
(If using a two-pedal foot switch, lower the work clamp before depressing the start switch.)
6. Release the TENSION/WIND key (3) after the machine starts operating, and keep depressing the foot switch until the lower thread stops being wound onto the bobbin. (If you release the foot switch before winding is complete, and then depress it again while pressing the TENSION/WIND key (3), winding will start again.)
7. Once winding of the set amount of lower thread (80–90% of the bobbin capacity) is completed, the bobbin presser arm (2) will return automatically.
8. Remove the bobbin, hook the thread onto the knife (4), and then pull the bobbin in the direction of the arrow to cut the thread.

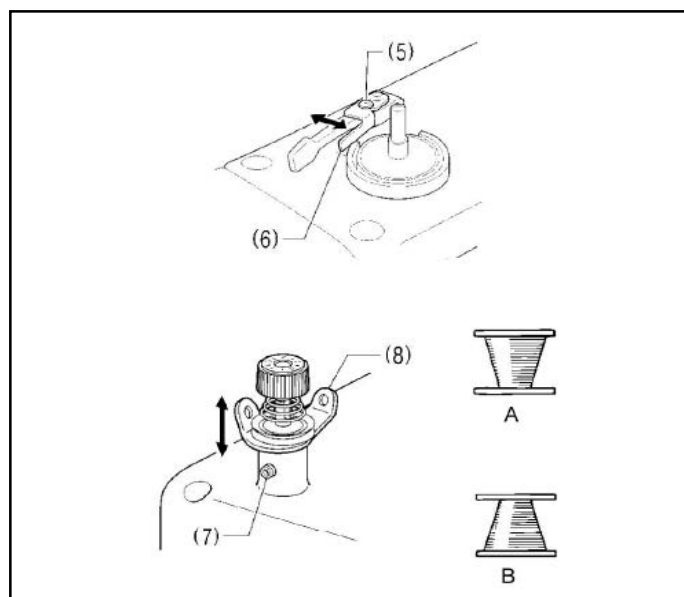

Adjusting the bobbin winding amount

Loosen the screw (5) and move the bobbin presser (6) to adjust.

If the thread winds onto the bobbin unevenly

Loosen the set screw (7) and move the bobbin winder tension assembly (8) up and down to adjust.

※ For case A, move the bobbin winder tension assembly (8) down, and for case B, move it upward.

4.5 Installing the bobbin case



CAUTION



Turn off the power switch before installing the bobbin case.

If the foot switch is depressed by mistake, the sewing machine might start operating and injury could result.

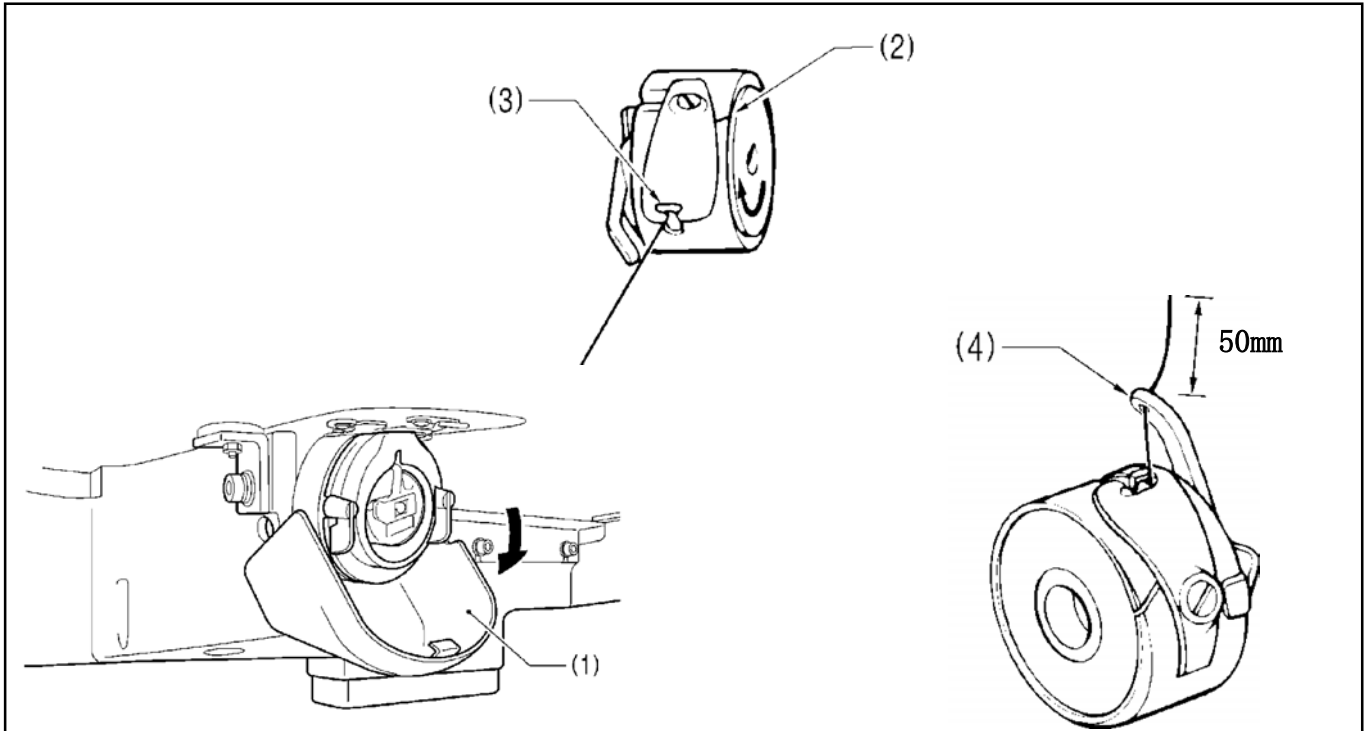

1. Pull the shuttle race cover (1) downward to open it.
2. While holding the bobbin so that the thread winds to the right, insert the bobbin into the bobbin case.
3. Pass the thread through the slot (2) and pull it out from the thread hole (3).
4. Check that the bobbin turns in the direction of the arrow when the thread is pulled.
5. Pass the thread through the lever thread hole (4), and then pull out approximately 30mm of thread.
6. Hold the latch on the bobbin case and insert the bobbin case into the rotary hook.

4.6 Thread tension

Thread tension reference

Upper thread	#20 or equivalent
Lower thread	#20 or equivalent
Upper thread tension (N)	1.4~1.8
Lower thread tension (N)	0.3~0.4
Pre-tension (N)	0.2~0.4
NEEDLE	DPX17#19

4.6.1 Lower thread tension

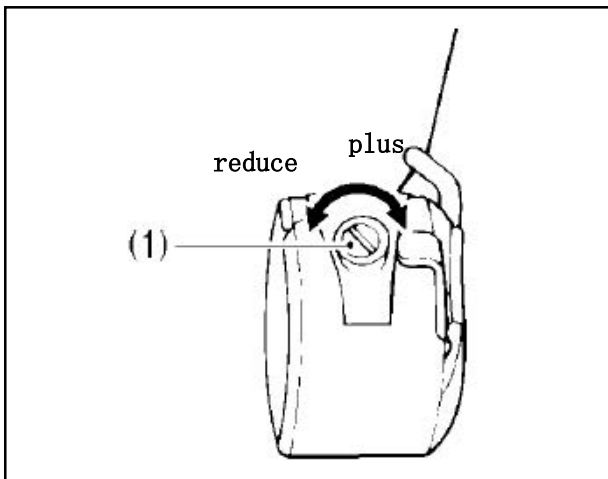

Adjust the thread tension to the weakest possible tension by turning the thread tension nut (1) until the bobbin case will not drop by its own weight while the thread end coming out of the bobbin case is held.

4.6.2 Upper thread tension

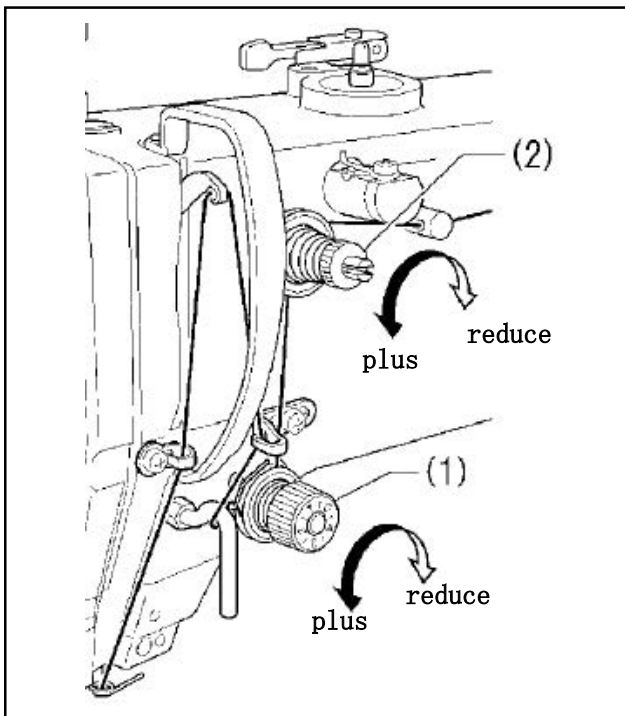

1. Turn the tension nut (1) (main tension) to adjust the tension as appropriate for the material being sewn.
2. Use the tension nut (2) (sub tension) to adjust the upper thread trailing length to about 42mm.

4.7 Home position detection

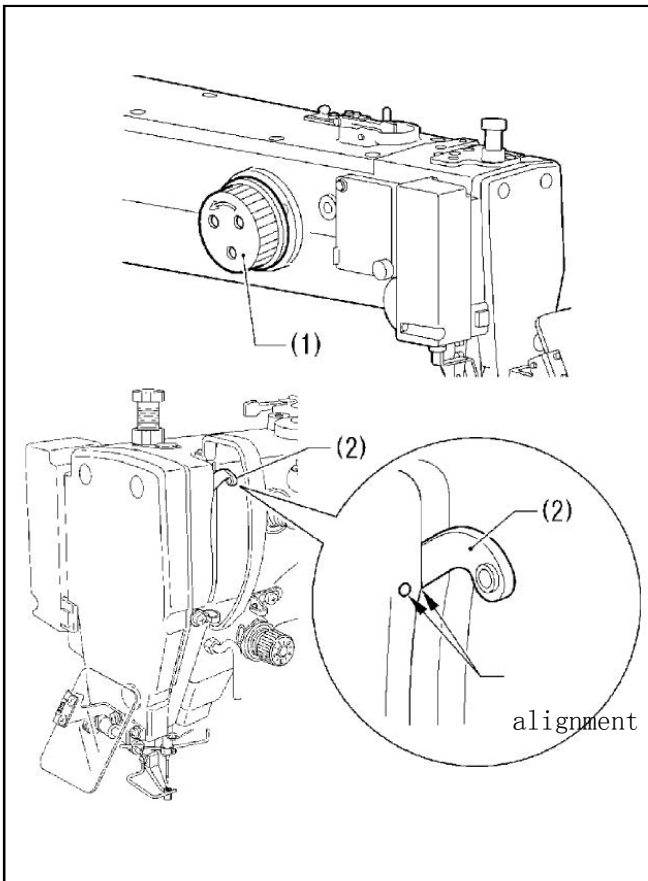

Before starting home position detection, check that the needle bar is at the needle up stop position.

Turn the pulley (1) until the ridge at the bottom of the thread take-up (2) is aligned with the mark (0) on the arm.

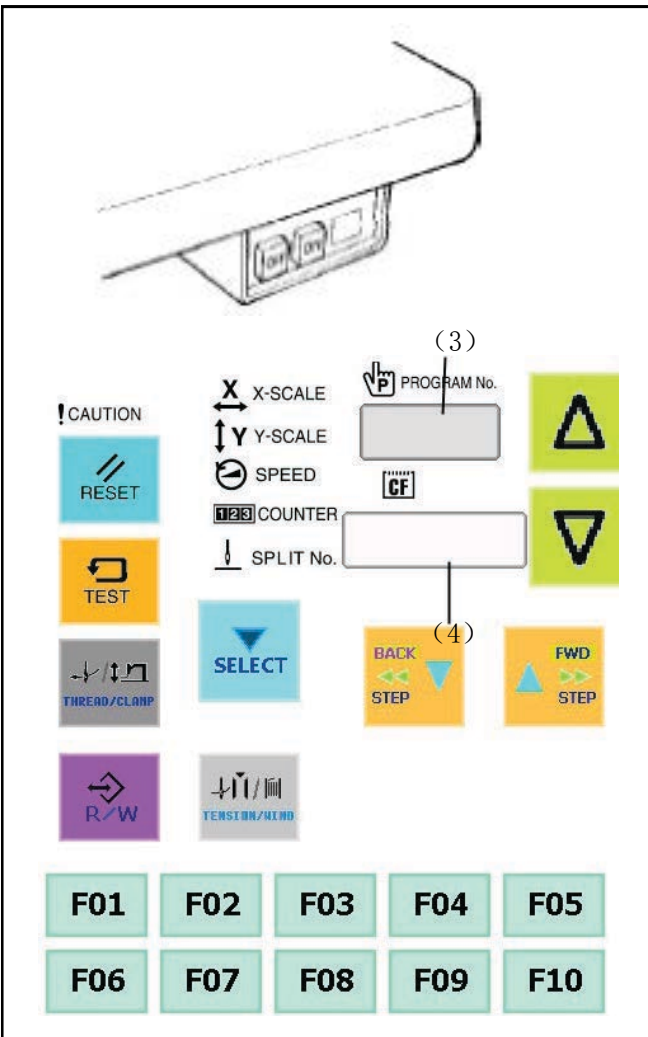

1. Turn on the power switch.

The POWER indicator (3) will illuminate, and the model name [] will appear in the PROGRAM No. display (4) and [Air] will appear in the menu display (5).



After this, the program number will flash in the PROGRAM No. display (4).

2. Depress the work clamp switch (6) to lower the work clamp, and then depress the start switch (7). (After home position detection is carried out, the work clamp will move to the sewing start position and then it will rise.)

*For programs with a large number of stitches, the buzzer will sound after the home position is detected, and then the work clamp will move to the sewing start position.

[Note]

If error [E110] is displayed when the start switch (7) is depressed, turn the pulley (1) in the direction of operation to clear the error display.

5. Use of touch screen

5.1 Setting program

5.1.1 Features

1) Stitch length

Can be set in the range 0.3 to 12.7 mm

2) Stitch count

The maximum stitch count per data is 20,000. (The sewing machine can hold 512 patterns and the CF card can hold 900 patterns. The holdable number of patterns created using a large number of stitches per data may be less.)

5.1.2 Making initial settings

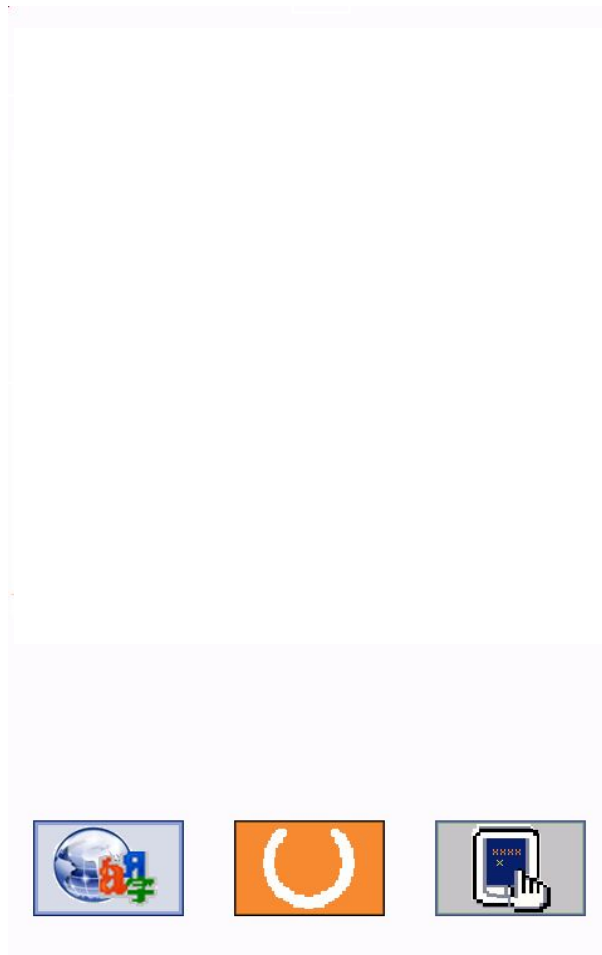

The following menu is displayed at power-up. press  to set up language.



此处可选择语言。

5.1.3 Functional overview

Press  to enter program menu after power-up.



The following icons will be displayed on the program menu.

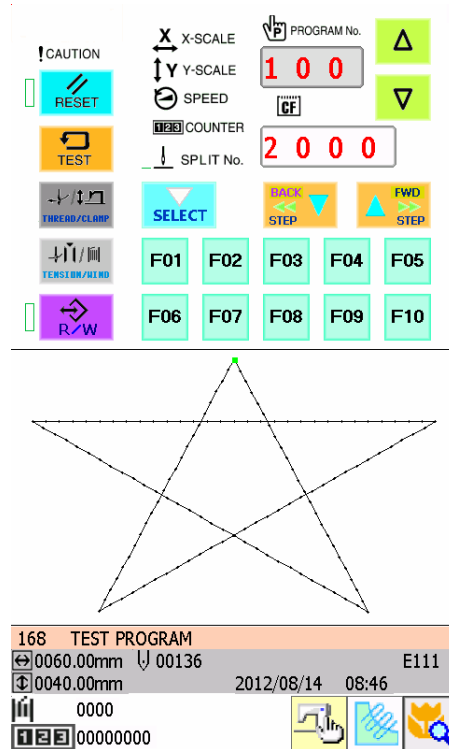

Press  to display the programming screen.

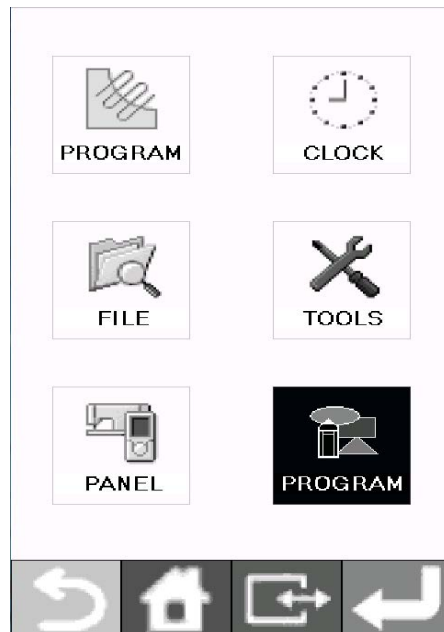

While being operated by the programmer, a number of icons are displayed on the screen which illustrate its operations and functions.

Please refer to the "5. Panel operation (basic operation), 6. Panel operation (advanced) and 7. Usage of CF card " on "instruction menu of CSM pattern sewing machine".

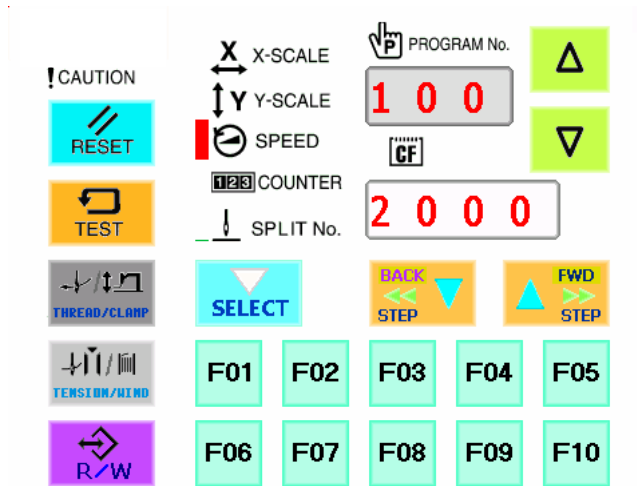

5.1.4 Making environment settings

1. Select , and press .



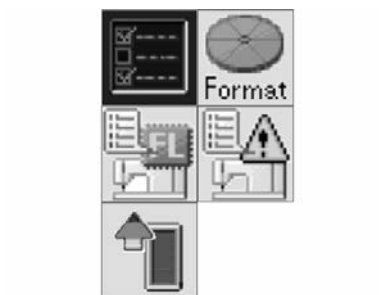

2. Select , and press .



3. Following setting up will be displayed.



 Buzzer Switches between ON and OFF of the buzzer sound.

 Volume Switches between ON and OFF of The key click sound.

 warn Switches between ON and OFF of the warning display.

 English Selects a language.



5.1.5 Notes on pattern sheet

About pattern sheet

- Write a pattern on thin plotting paper or use copies of pattern sheet.
- Design pattern sheet in full scale. Adjust the size to magnification (2, 5, or 10) when using the magnified input.

5.2 Programming with icons

While being operated by the programmer, a number of icons are displayed on the screen which illustrate its operations and functions.

This chapter describes the procedure for programming with icons.

- Other than programming with the icons, programming with commands is also possible. Holding down  allows the user to switch between the mode for programming with icons and the mode for programming with commands.

⇒ Refer to Chapter 4 "Programming with Commands"

5.2.1 Programming with icons

1) Keys to be used

This section describes keys to be used for programming with icons.

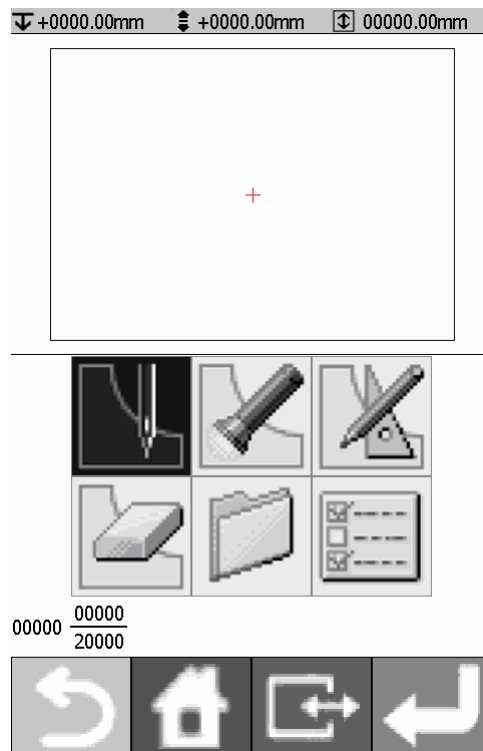

Press this key to return to the previous step or to cancel a setting



The screen returns to the launcher screen.



Switches the display size of an image. Hold this key down to switch to the command mode.





Press this key to confirm settings

2) Make environment settings



Make environment settings of the programmer

The following items can be set:	Creates data so that the pitch becomes equal within the specified pitch range when the smoothing function is used.
Smoothing equal pitch	
Area check	Does not create data outside the sewing area when program is being created or edited.
Marker display	Displays a marker on the screen.
JOG acceleration pattern	Changes the moving speed of a feed.

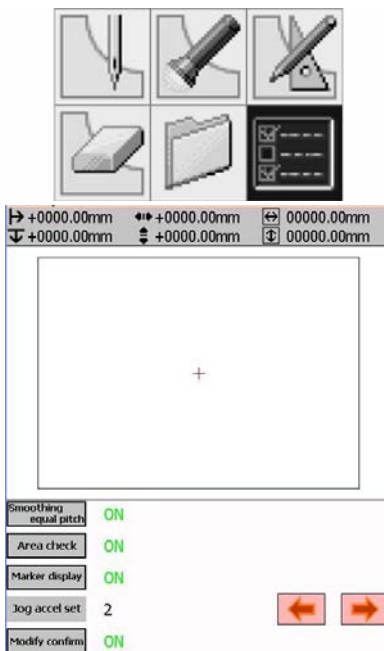
Select . Press .



a. Select the Icons to set up the functions.

b. Change the JOG acceleration pattern value by using  

c. After setting is complete, press 

3) Programming screen

On the launcher screen, select  and press  to display the programming screen.

If the screen is not displayed, hold down .

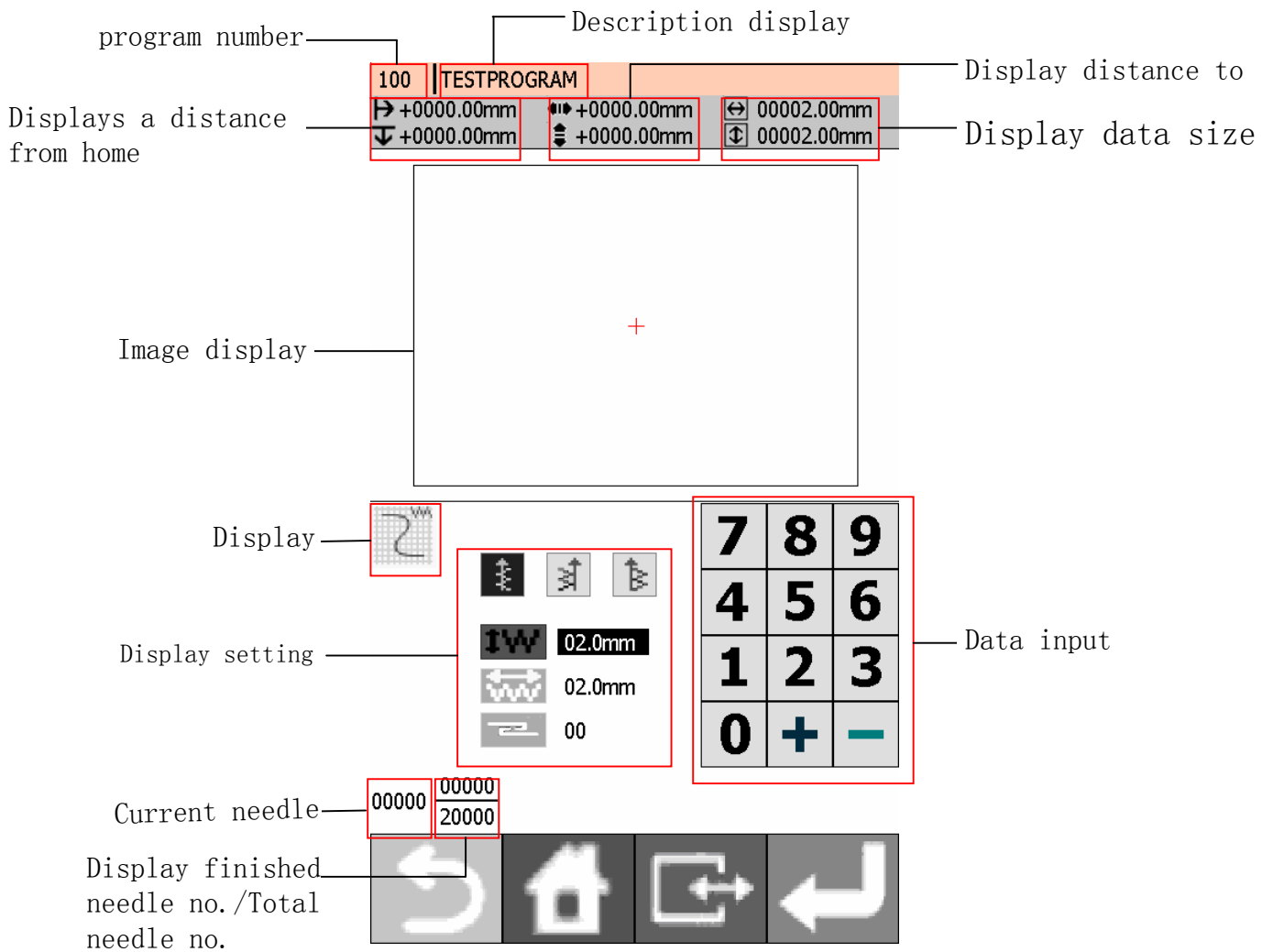
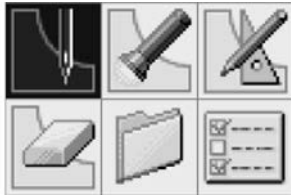

4) Description of icons



Programming



Specifying the sewing start point



Outline



Creating a line



Creating a curve



Creating a zigzag stitch



Creating double stitch data in the reverse direction of the sewing path



Creating double stitch data in the same direction as the sewing path



Creating a multiple stitch



Creating one stitch



Creating feed data



Creating basting data



Creating trace data



Creating magnified data



Creating code



Setting the thread trimming code



Setting the option output code



Setting the low speed code



Setting the split speed code



Setting the height of presser foot



Setting a thread tension



Inputting an end code





Checking the program setting and setting attribute

 Editing the current program

 Moving a pattern in parallel by feeding

 A part of parallel moving continuous programming

 Repeated copying a pattern

 Copying a pattern symmetrically to the Y-axis

 Copying a pattern symmetrically to the X-axis

 Copying a pattern symmetrically to a point

 Copying in the reverse direction

 Deleting a part of the program

 Editing program

 Moving a pattern in parallel by feeding

 Repeated copying a pattern

 Copying a pattern symmetrically to the Y-axis

 Copying a pattern symmetrically to the X-axis

 Copying a pattern symmetrically to a point

 Copying in the reverse direction

 Deleting a part of the program

 Copying a resized pattern to the center point of data

 Rotating a pattern (clockwise or counterclockwise)

 Copying a rotated pattern (clockwise or counterclockwise)

 Rotating a pattern to the center point of data (clockwise or counterclockwise)

 Copying a rotated pattern to the center point of data (clockwise or counterclockwise)

 File

 Reading program

 Writing program



 Deleting a file

 Formatting

5.2.2 Procedure for programming with icons

The procedure for programming with icons is as follows.

1) Displaying the programming screen

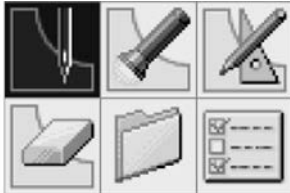

On the launcher screen, select  and press .

If the programming screen does not appear, hold down .







The work clamp moves to the home position and the programming screen is displayed.

2) Starting program creation

Select , and press .

3) Positioning the machine needle point at the first stitch of pattern sheet

USE  to move work clamp, and Press  when the needle point is at the first stitch of the pattern sheet.

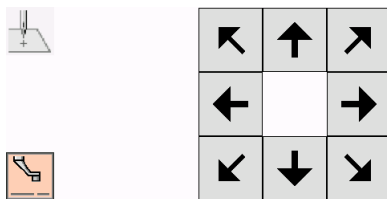

The first stitch is programmed and the following screen appears.

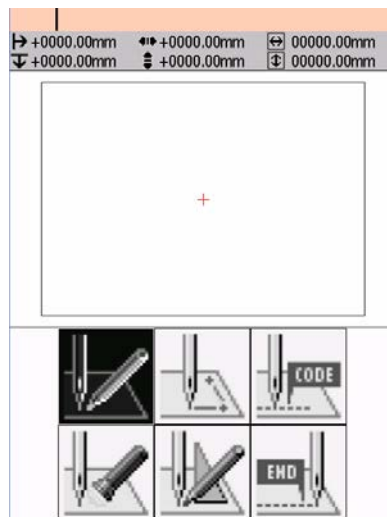



4) Creating program

Select an icon depending on your goal on the screen displayed in step 3 to create program for the pattern you want.



The program is available until deletion. For details about program creations, refer to "Programming example"/"Programming"

5) Inputting an end code

When programming is completed, input an end code to control the machine operation.

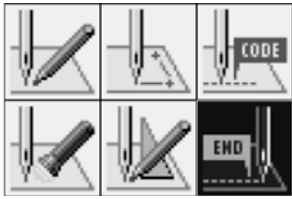
- a. Select , and press 



- b. Select an end code type with  , and press 

The following six end codes from 111 to 116 are available, each of which carries out machine operations as shown in the table below.

Program with no end code set is not available on the machine. A machine error occurs.

To prevent incomplete program from being used in error, you can make a conscious choice not to set any end code.

111 Normal end

112 Fixing the sewing speed at 1200 rpm or lower

113 Carrying out no thread wiping

114 Setting the sewing speed at 1200 rpm or lower without thread wiping

115 Carrying out no thread trimming

116 Fixing the sewing speed at 1500 rpm or lower

* 117-119 are not available.

The following sample use 111 as end code.



The work clamp returns to the first stitch.

- c. Press 

The work clamp returns to the home position.

6) Saving the created program

- a. select , and press 



- b. select , and press 



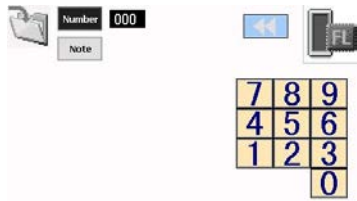

c. Input the program number, and then press.



d. Use **Note** to input the comments.



e. Press  to save the file.

Note: To confirm the contents of the save destination, select . The files are saved in flash memory of sewing machine on default.

7) Ending programming

Press  return to initial screen.

5.2.3 Programming example

1) Programming for each stitch

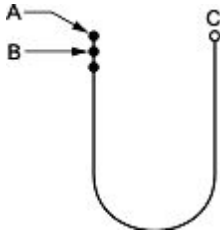

The following describes how to perform programming for each stitch according to the pattern sheet.





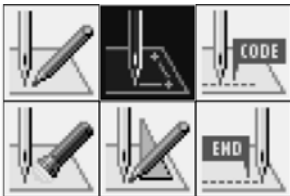

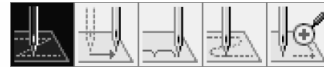

a. Carry out steps 1 to 3 of "Procedure for programming with icons".

b. Select , and then Press .



c. Select , and then Press .



d. Move the work clamp with , Press  when the needle point is at point B of the pattern sheet.

e. Create the program to point C as in step 4.

f. When point C is programmed, press  twice.



g. Carry out steps 5 to 7 of "Procedure for programming with icons".

2) Pattern with lines

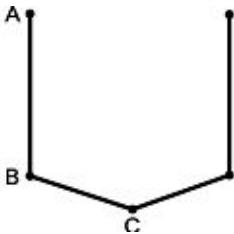

The following describes how to program a pattern with lines.



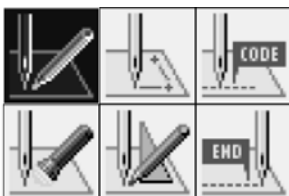

a. Carry out steps 1 to 3 of "Procedure for programming with icons".

b. Select , and press .



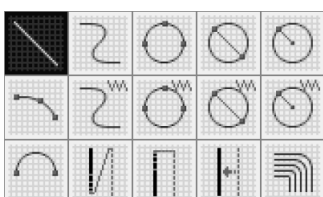



c. Select , and press .



d. Input the stitch length, and then press . Input "030" to make the stitch length 3.0 mm.



e. Move the work clamp with , Press  when the needle point is at point B of the pattern sheet.

f. Create the program to points C, D and E as in step 5.

g. When point E is programmed, press  three times.

h. Carry out steps 5 to 7 of "Procedure for programming with icons".

3) Pattern with curves

The following describes how to program a pattern with curves.

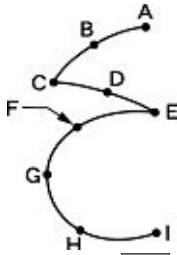

Be sure to press twice to make a split at corner points C or E. If a split is not made, the corner will be rounded.

When a split is made



When a split is not made



Making more intermediate points such as points B, D, F, G, and H creates smoother curves.

a. Carry out steps 1 to 3 of "Procedure for programming with icons".

b. Select , and press .

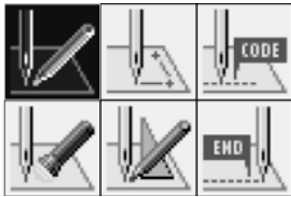

c. Select , and press .

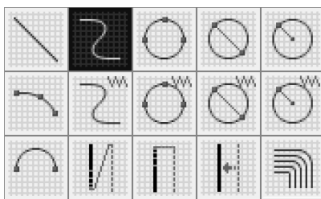

d. Input the stitch length, and then press .



Input "030" to make the stitch length 3.0 mm.

e. Move the work clamp with , , , . Press

when the needle point is at point B.

f. Program point C as in step 5.

g. When point C is programmed, press again for . To change the stitch length, press to reset.

h. Create the program to point E.

j. When point E is programmed, press .

k. Create the program to point I.

l. When point I is programmed, press .



m. Press three times.

n. Carry out steps 5 to 7 of "Procedure for programming with icons".

5.2.4 Procedure for modifying program

The procedure for modifying the program by using icons is as follows.

1) Calling program to be modified

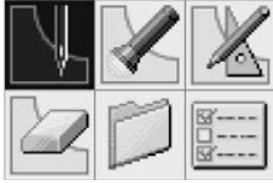

- a. On the launcher screen, select  and press . If the programming screen does not appear, hold down 

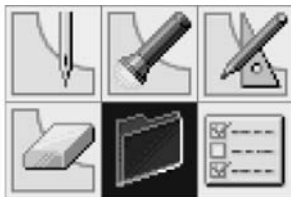

The work clamp moves to the home position and the programming screen is displayed.

- b. Select , and press 





- c. Select , and press 

2) Starting program modification

Select the relative button to modify, depending on your reason for modifying the program.

For details about program modification, refer to "Example of modified program"

3) Saving the modified program

- a. Select , and press 

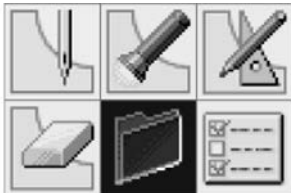

- b. Select , and press 





- c. Input the program number.

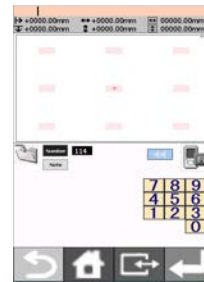
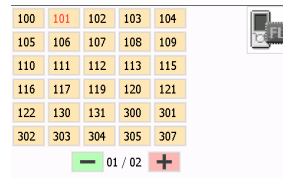
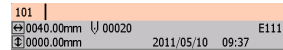

- d. Select the pattern no. which need to be modified.

Press 



- d. Press  to select characters or number to input the comments.



- e. Press  to save the pattern.

4) Ending programming

Press , and return to the launch screen.

5.2.5 Example of modified program

1) Modifying a part of pattern

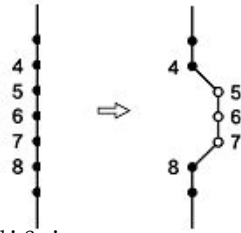

part of the programmed pattern is changed. The following describes how to modify 5, 6 and 7 to 5', 6' and 7'.



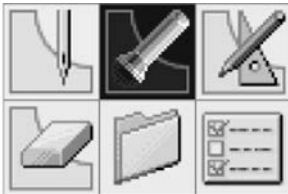

a. Carry out step 1 of "Procedure for modifying program" to call program.



b. Select , and press 





c. Press **9 9 9**, and then press . The work clamp moves from the start point by each stitch.  999

d. When the needle point reaches 4, press . The work clamp stops. When returning the needle point, input the number of stitches to be returned and press 



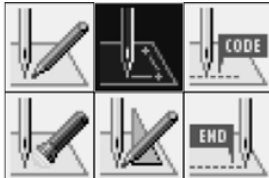

e. Press 

f. Select , and press 

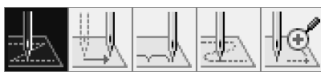

g. Select , and press 



h. Move the work clamp with  Press  when the needle point is at 5'.

i. Program 6' and 7' as in step 4.

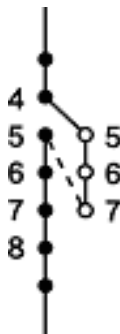

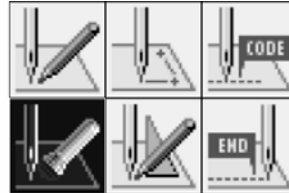

j. Press  two times.

k. Select , and press 





l. Press **1** and then press . The needle point moves to 5.

m. Press 

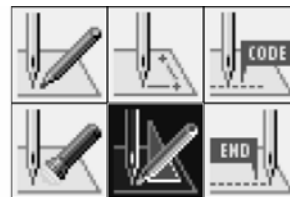
Select , Select , and press 



n. Select , and press 

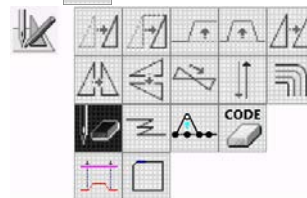

o. Input the number of stitches to be deleted, and then press 

In the example, 3 stitches ahead are deleted: pre **3** . The needle point moves to 6, 7 and 8. Points 5, 6 and 7 are deleted.

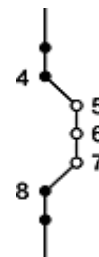

p. Press  three times.



q. Carry out steps 3 and 5 of "Procedure for modifying program" to save program.

2) Moving the pattern in parallel (when the first stitch is the sewing start point)

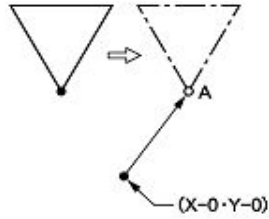

The following describes how to move the pattern in parallel when the first stitch is the sewing start point..







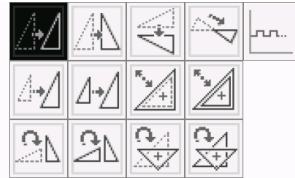

a. Carry out step 1 of "Procedure for modifying program"

b. Select , and press 



Select , and press 



c. Move the work clamp with . Press  when the needle point is at point A of the pattern sheet.

d. Press 

e. Carry out steps 3 to 5 of "Procedure for modifying program".

3) Deleting a part of data during programming

The following describes how to delete 2 stitches (7 and 8) at point 8 and creating a new program.

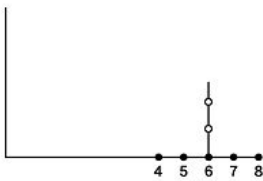

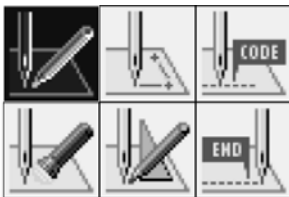

a. Press  during programming to display the screen below.



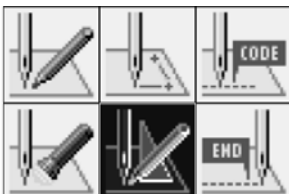

b. Select , and then press 

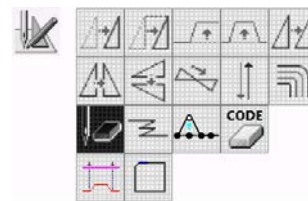

c. Select , and then press 



d. Input the number of stitches to be deleted, and then press . In the example, the 2 previous stitches are deleted. Press  

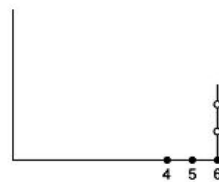

The needle point moves to 6.

e. Press  twice.

f. Continue programming.

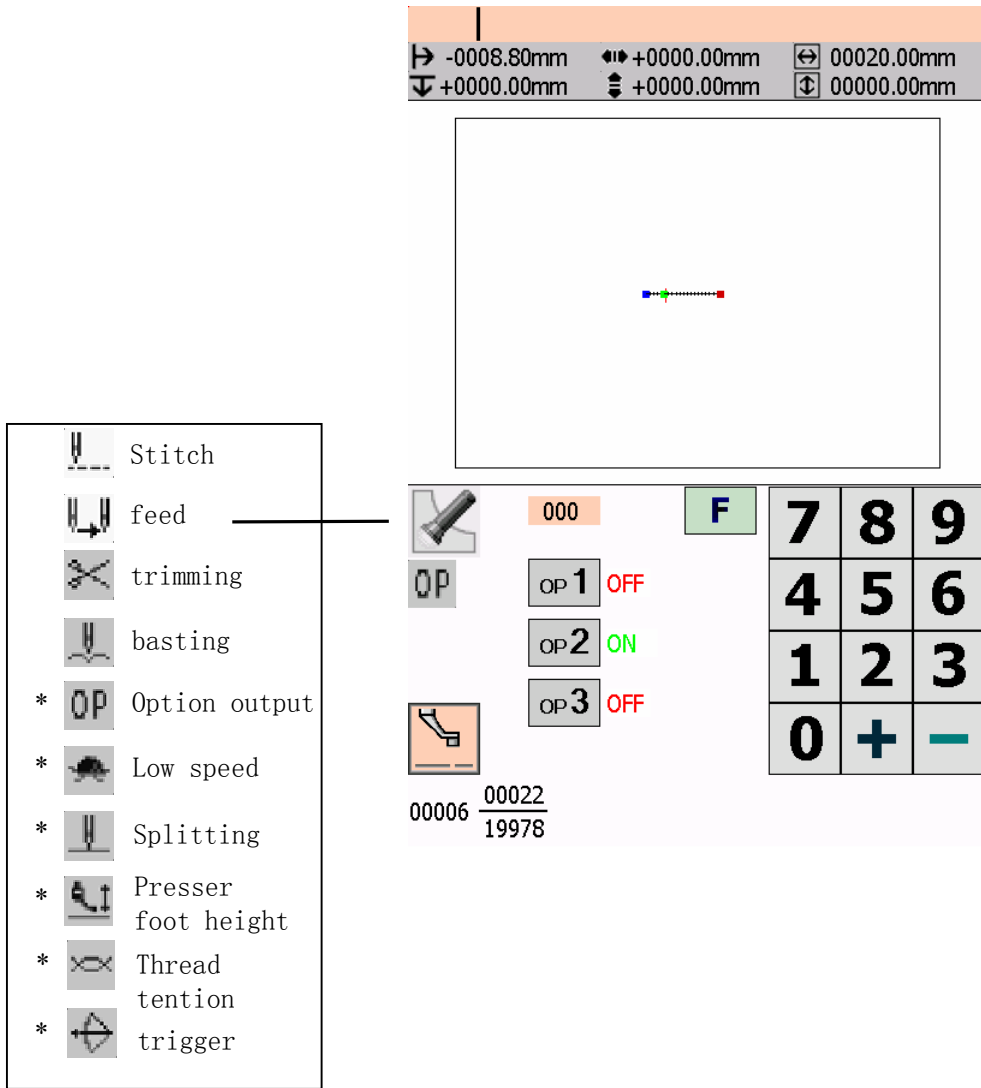

5.2.6  Checking the program setting and setting attributes It is possible to check the program setting and setting attributes. The following items are displayed



The screenshot shows a control panel with several sections:

- Top Panel:** Displays various offset settings:
 - Left: \rightarrow -0008.80mm, \downarrow +0000.00mm
 - Middle: \leftarrow +0000.00mm, \updownarrow +0000.00mm
 - Right: \leftrightarrow 00020.00mm, \updownarrow 00000.00mm
- Center:** A large empty rectangular area with a small multi-colored dot in the center.
- Left Column (List of Options):**
 - Stitch
 - feed
 - trimming
 - basting
 - * Option output
 - * Low speed
 - * Splitting
 - * Presser foot height
 - * Thread tension
 - * trigger
- Right Column (Control Elements):**
 - 000
 - F** (Green button)
 - 7 8 9** (Number buttons)
 - 4 5 6** (Number buttons)
 - 1 2 3** (Number buttons)
 - 0 + -** (Number and function buttons)
 - OP** (Option button)
 - OP 1 OFF (Red text)
 - OP 2 ON (Green text)
 - OP 3 OFF (Red text)
 - 00006 $\frac{00022}{19978}$

Regarding data type items marked with *, you can set their attributes.

Select  or , and then press 

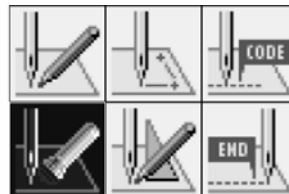

1) Checking each stitch

Press **+** to move forward, and press **-** to move backward.

The needle steps by each stitch and the data settings are displayed.

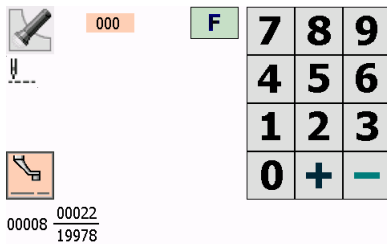

2) Checking a series of stitches automatically

a. Input the stitch count to move.

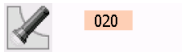

b. Press **+** to move the needle forward, and press **-** to move it backward.

The needle moves according to the input count, and the setting of the data is displayed. Input "999" to check all stitches.

3) Skipping

a. Input the stitch count to the destination.

b. Press **F**, and then press **+** to move the needle forward and **-** to move it backward.

The needle skips sewing according to the input stitch count.

Input "999" to skip sewing to the sewing end point or to a breakpoint.

4) Setting the attribute

a. Move the needle to the position you want

the command at, and then press **↩**

The attribute setting screen appears.

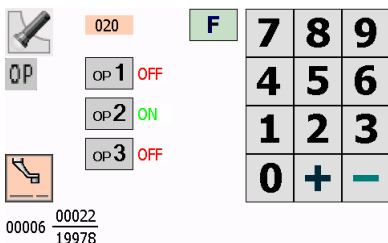

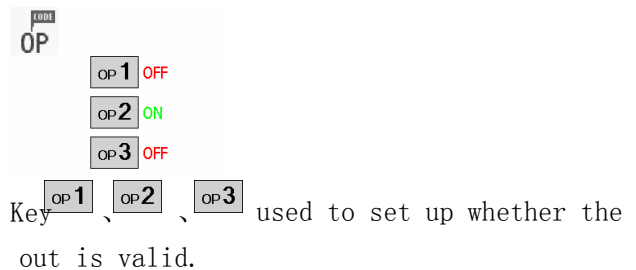

b. Set the attribute. (Example: option output)





c. Press **↩** after setting. The screen returns to the confirmation screen.

5.2.7 Deleting program being created/edited



Delete program being edited.

a. Press  or  to display the programming screen.

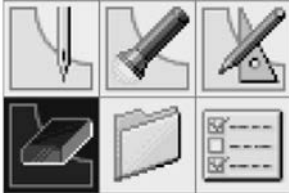
b. Select , and then press .



The confirmation screen appears.

c. Press  to delete program, and then press  to cancel this command.

5.3 Programming with commands







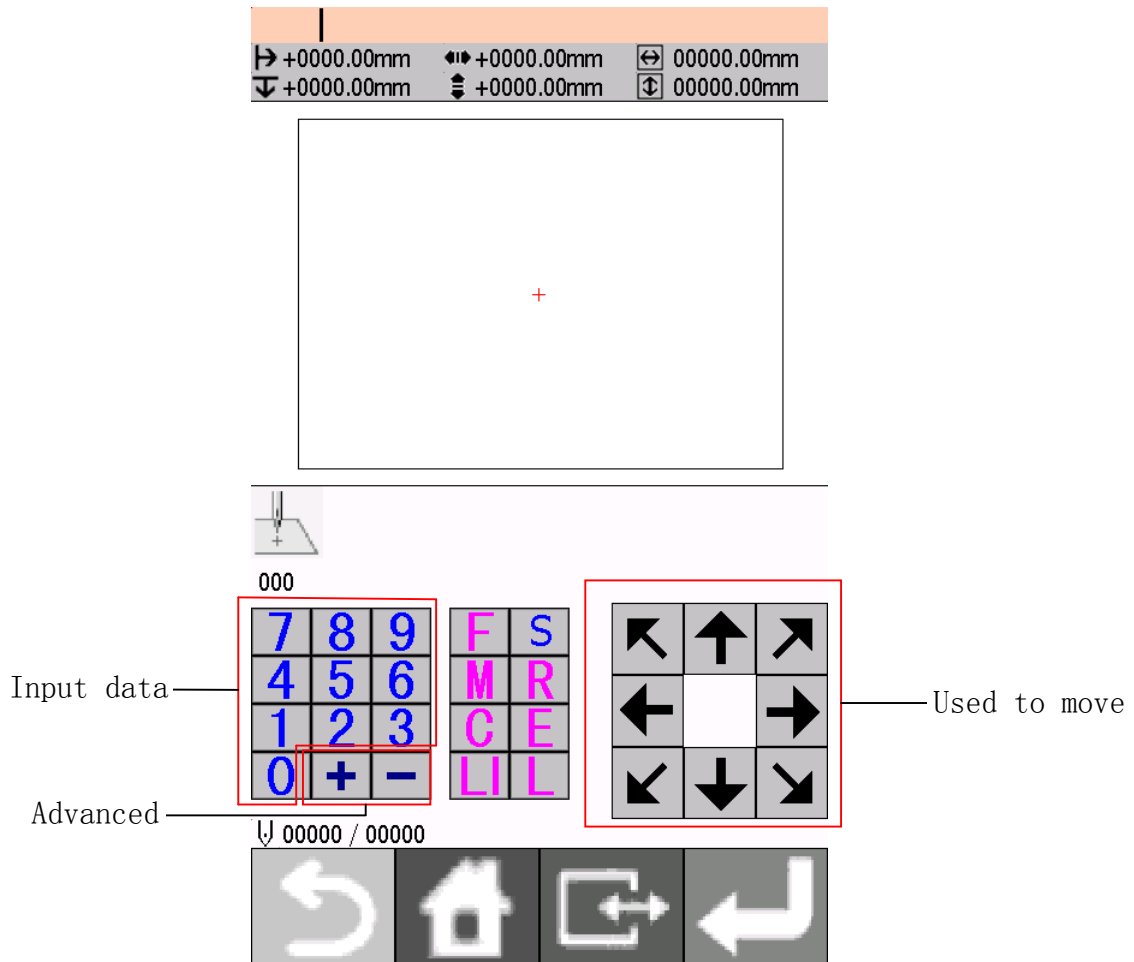

Pressing combinations of specific keys on this machine allows programming. These key combinations are called 'commands'. This chapter describes the method of programming with commands.

* Other than programming with commands, programming with icons is also possible. Holding down allows users to switch between the mode for programming with icons and the mode for programming with commands.

Refer to Chapter 3 "Programming with Icons".

1) Keys to be used



-  Returns to the launcher screen..
-  Switches the display size of an image. Hold this key down to switch to the command mode.
-  Press this key to perform feed or create basting.
-  Saving patterns.
-  Press this key for smoothing or editing.
-  Cancels operation.
-  Deletes a part of the data.
-  Inputs the end code.



Press this key to create a line or a circle.



Press this key to set the needle position or use this key as a part of a command.

On the launcher screen, select the icon  and press  to display the programming screen. If the screen is not displayed, hold down 

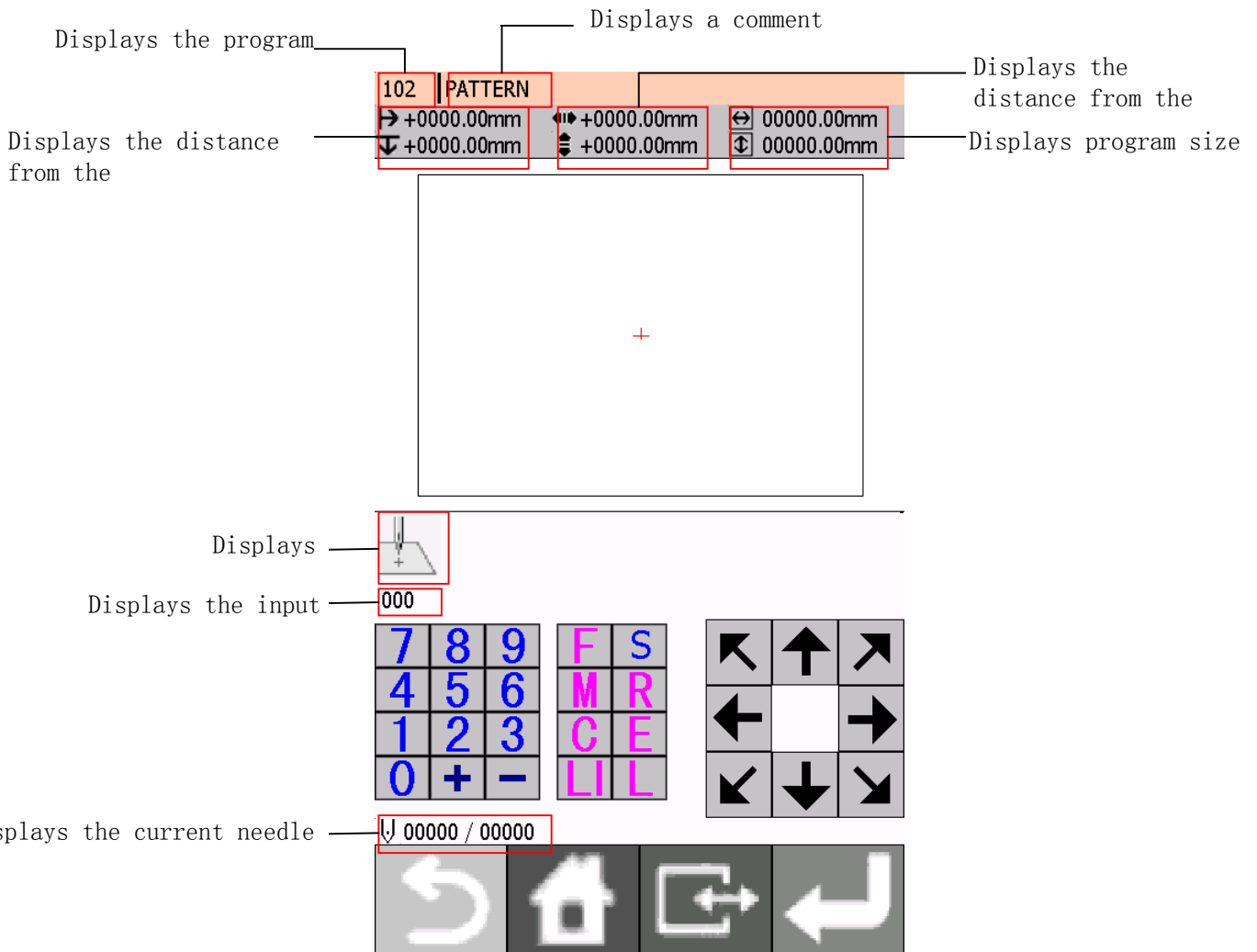

2) Description of Commands

Moving needle point

<input type="text"/> <input type="text"/> <input type="text"/> <input type="text"/> +	Proceeding by <input type="text"/> <input type="text"/> <input type="text"/> stitch
<input type="text"/> <input type="text"/> <input type="text"/> <input type="text"/> -	Returning by <input type="text"/> <input type="text"/> <input type="text"/> stitch
9 9 9 +	Proceeding to the end point
9 9 9 -	Returning to the first point
F <input type="text"/> <input type="text"/> <input type="text"/> +	Proceeding by skipping <input type="text"/> <input type="text"/> <input type="text"/> stitch
F <input type="text"/> <input type="text"/> <input type="text"/> -	Returning by skipping <input type="text"/> <input type="text"/> <input type="text"/> stitch
F 9 9 9 +	Skipping to the end point (not applicable at the home position)
F 9 9 9 -	Skipping to the first point
R	Returning the position to the home position

Programming

Line	<input type="text"/> <input type="text"/> <input type="text"/> L	Creating a line (Input the stitch length in <input type="text"/> <input type="text"/> <input type="text"/>)
Curve	<input type="text"/> <input type="text"/> <input type="text"/> M	Creating a curve (Input the stitch length in <input type="text"/> <input type="text"/> <input type="text"/>)
	7 8 9 L	Ending input for a curve
Zigzag	7 <input type="text"/> <input type="text"/> M	Creating a zigzag stitch (After inputting the width of the zigzag in <input type="text"/> <input type="text"/> input the pitch of the zigzag stitch in <input type="text"/> <input type="text"/> M)
	7 8 7 L	Carrying out a zigzag stitch on the right side of the sewing path
	7 8 8 L	Carrying out a zigzag stitch on the left side of the sewing path
	7 8 9 L	Carrying out a zigzag stitch symmetrical to the sewing path
Splitting	2 2 0 L	Stopping the needle at the upper end by split
	2 2 1 L	Stopping the needle at the lower end by split
Double stitch	2 <input type="text"/> <input type="text"/> M	Creating a double stitch in the reverse direction of the sewing (Input the width of the double stitch in <input type="text"/> <input type="text"/>)
	7 8 8 L	Carrying out a double stitch on the right side of the sewing path
	7 8 9 L	Carrying out a double stitch on the left side of the sewing path
Parallel stitch	3 <input type="text"/> <input type="text"/> M	Creating a parallel stitch in the same direction as the sewing path (Input the width of parallel stitch in <input type="text"/> <input type="text"/>)
	7 8 8 L	Carrying out a parallel stitch on the right side of the sewing path
	7 8 9 L	Carrying out a parallel stitch on the left side of the sewing path
Basting	F 8 8 8 L	Creating split data after basting data
	F 9 9 9 L	Creating basting data
Feed	F 6 6 6 L	Specifying split points (for sewing different patterns separately in a sequence) after feed
	F 7 7 7 L	Moving in parallel for the feed
Trace	5 <input type="text"/> <input type="text"/> L	Creating data by tracing a pattern

Editing program

<input type="button" value="0"/> <input type="button" value="0"/> <input type="button" value="1"/> <input type="button" value="M"/>	Moving a pattern symmetrical to the Y-axis
<input type="button" value="0"/> <input type="button" value="1"/> <input type="button" value="0"/> <input type="button" value="M"/>	Moving a pattern symmetrical to the X-axis
<input type="button" value="0"/> <input type="button" value="1"/> <input type="button" value="1"/> <input type="button" value="M"/>	Moving a pattern symmetrical to a point
<input type="button" value="8"/> <input type="button" value="8"/> <input type="button" value="8"/> <input type="button" value="M"/>	Resizing a pattern (Input the magnification in the X direction in <input type="text"/> <input type="text"/> <input type="text"/> <input style="float:right" type="button" value="F"/> , and input the magnification in the Y direction in <input type="text"/> <input type="text"/> <input type="text"/> <input style="float:right" type="button" value="M"/>)
<input type="button" value="9"/> <input type="button" value="9"/> <input type="button" value="9"/> <input type="button" value="M"/>	Copying a resized pattern (Input the magnification in the X direction in <input type="text"/> <input type="text"/> <input type="text"/> <input style="float:right" type="button" value="F"/> , and input the magnification in the Y direction in <input type="text"/> <input type="text"/> <input type="text"/> <input style="float:right" type="button" value="M"/>)
<input type="button" value="3"/> <input type="button" value="3"/> <input type="button" value="3"/> <input type="button" value="L"/>	Repeated copying
<input type="button" value="4"/> <input type="button" value="4"/> <input type="button" value="0"/> <input type="button" value="L"/>	Copying symmetrically to a point
<input type="button" value="4"/> <input type="button" value="4"/> <input type="button" value="1"/> <input type="button" value="L"/>	Copying a pattern symmetrically to the X-axis
<input type="button" value="4"/> <input type="button" value="4"/> <input type="button" value="2"/> <input type="button" value="L"/>	Copying a pattern symmetrically to the Y-axis
<input type="button" value="4"/> <input type="button" value="4"/> <input type="button" value="3"/> <input type="button" value="L"/>	Copying in the reverse direction
<input type="button" value="7"/> <input type="button" value="7"/> <input type="button" value="7"/> <input type="button" value="L"/>	Moving data in parallel before the current needle position (changing the moving amount data of the needle position)

Setting attribute

<input type="button" value="6"/> <input type="button" value="6"/> <input type="button" value="6"/> <input type="button" value="L"/>	Setting the maximum sewing speed at 400 rpm or lower
<input type="button" value="6"/> <input type="button" value="6"/> <input type="button" value="7"/> <input type="button" value="L"/>	Setting the maximum sewing speed at 1200 rpm or lower
<input type="button" value="6"/> <input type="button" value="6"/> <input type="button" value="8"/> <input type="button" value="L"/>	Setting the maximum sewing speed at 800 rpm or lower
<input type="button" value="6"/> <input type="button" value="6"/> <input type="button" value="9"/> <input type="button" value="L"/>	Setting the maximum sewing speed at 600 rpm or lower
<input type="button" value="6"/> <input type="button" value="6"/> <input type="button" value="0"/> <input type="button" value="L"/>	Canceling low speed data setting
<input type="button" value="7"/> <input type="button" value="7"/> <input type="button" value="1"/> <input type="button" value="L"/>	Turning on option output 1
<input type="button" value="7"/> <input type="button" value="7"/> <input type="button" value="2"/> <input type="button" value="L"/>	Turning on option output 2
<input type="button" value="7"/> <input type="button" value="7"/> <input type="button" value="3"/> <input type="button" value="L"/>	Turning on option output 3
<input type="button" value="7"/> <input type="button" value="7"/> <input type="button" value="0"/> <input type="button" value="L"/>	Turning off all option outputs
<input type="button" value="9"/> <input type="button" value="0"/> <input type="button" value="0"/> <input type="button" value="L"/>	Canceling setting for the height of presser foot
<input type="button" value="9"/> <input type="text"/> <input type="text"/> <input type="button" value="L"/>	Setting the height of presser foot (Input the height of presser foot from 0 to 99 <input type="text"/> <input type="text"/>)

Deleting program

<input type="button" value="2"/> <input type="button" value="2"/> <input type="button" value="2"/> <input type="button" value="R"/>	Deleting all data
---	-------------------

Ending programming

<input type="button" value="1"/> <input type="button" value="1"/> <input type="button" value="1"/> <input type="button" value="E"/>	Normal end
<input type="button" value="1"/> <input type="button" value="1"/> <input type="button" value="2"/> <input type="button" value="E"/>	Fixing the sewing speed at 1200 rpm or lower
<input type="button" value="1"/> <input type="button" value="1"/> <input type="button" value="3"/> <input type="button" value="E"/>	Carrying out no thread wiping
<input type="button" value="1"/> <input type="button" value="1"/> <input type="button" value="4"/> <input type="button" value="E"/>	Setting the sewing speed at 1200 rpm or lower without thread wiping
<input type="button" value="1"/> <input type="button" value="1"/> <input type="button" value="5"/> <input type="button" value="E"/>	Carrying out no thread trimming
<input type="button" value="1"/> <input type="button" value="1"/> <input type="button" value="6"/> <input type="button" value="E"/>	Fixing the sewing speed at 1500 rpm or lower

ther operations

save data (Input the pattern no. in)



returning to the launcher screen



Switching the display size of an image. Hold this key down to switch to the command mode



Canceling command

3) The procedure for programming with commands is as follows.

a. Displaying the programming screen

On the launcher screen, select icon. Press to display the programming screen.

If the screen is not display, hold down

The work clamp moves to the home position and the programming screen is displayed.

b. Positioning the machine needle point at the first stitch of pattern sheet

Move the work clamp using Press when the needle point is at the first stitch of the pattern sheet.

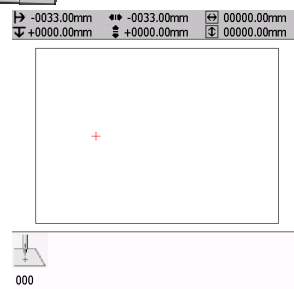

The first stitch is programmed and the following screen appears.

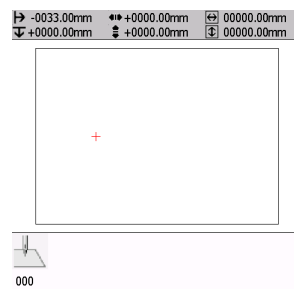

c. Creating program

Input a command depending on your purpose for creating program for the pattern you want to create. The program is available until deletion. For details about program creations, refer to "Programming example" "Programming"

b. Inputting an end code

When programming is completed, input an end code to control the machine operation.

The following six end codes from 111 to 116 are available, each of which are set as shown in the table below. Program with no end code set is not available on the machine. To prevent incompleted program from being used by mistake, you can choose not to set any end code.

Normal end

Fixing the sewing speed at 1200 rpm or lower

Carrying out no thread wiping

Setting the sewing speed at 1200 rpm or lower without thread wiping

1 1 5 E

Carrying out no thread trimming

1 1 6 E

Fixing the sewing speed at 1500 rpm or lower

Input an End code

1 1 1 E

is selected in the example

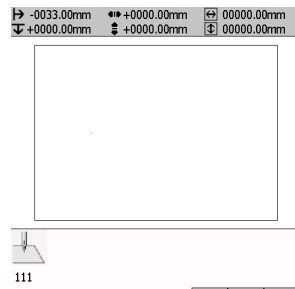

c、 Saving the created program

Specify the program number on the operation panel and press the read/write switch for writing into a media. For details of operations, refer to Chapter 6 "Saving program".

f、 Ending programming

Press  return to the programming screen.

5.4 Formatting media

Format media to make them available for the programmer. The following two formatting procedures are provided.

This operation is not available in command mode.

1) Formatting procedure 1

a. Execute steps 1 to 3 of "Procedures for reading/saving/deleting program and formatting media".

b. Select , and press 



c. Select a medium. Press 



d. To start formatting, press 

To cancel formatting, press 

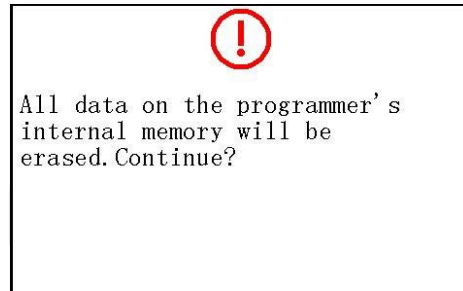

2) Formatting procedure 2

a. Select  on the launcher screen.

Press 



b. Select . Press 



c. To start formatting, press 

d. To start formatting, press 

To cancel formatting, press 

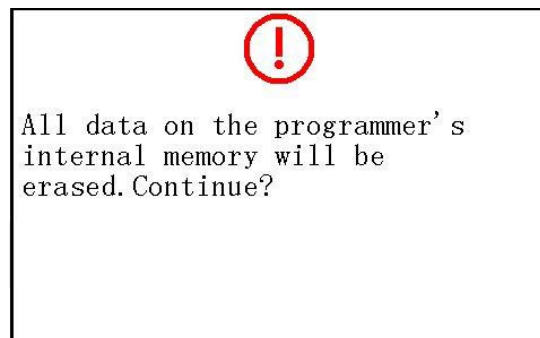

5.5 Checking program

5.5.1 Displaying program information

a、 Turn on the machine.

b、 Select  Press 

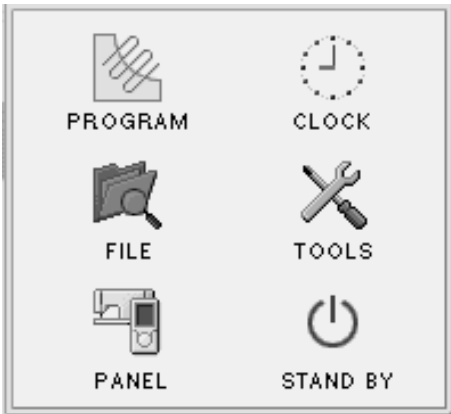

Selecting a program display method

5.5.2 Display of thumbnails

1) Display of thumbnails

Displays selected program in the folder of a media

Displays program number — **168** | **TEST PROGRAM** — Displays a detail of program.

Displays a detail of program. — **← 0060.00mm ↓ 00136 E111**
↓ 0040.00mm 2012/08/14 08:46

Display a program image —

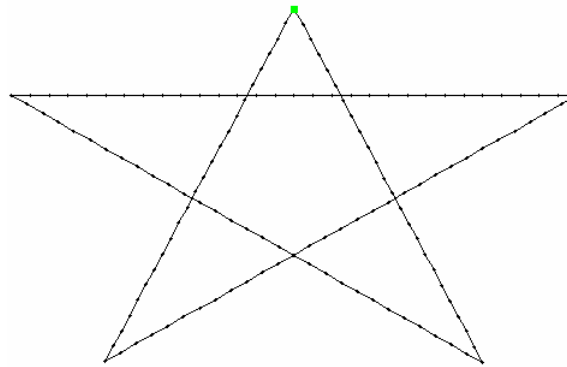

Display program quantity —

100	101	102	103	104
105	106	107	108	109
110	111	112	113	115
116	117	119	120	121
122	130	131	168	169
300	301	302	303	304



Displays an access destination medium.



Switching between single selection and multiselection

Current page/
entire number of pages

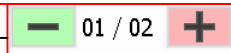

2) Switching between pages

To display the next page, press . To display the previous page, press .

3) Switching between media

a. Select . Other information will be displayed according to the different media.

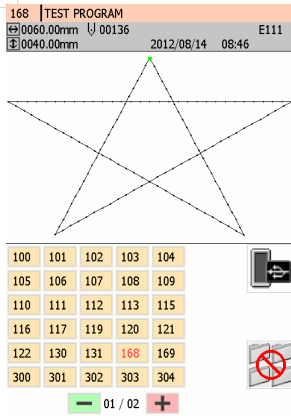

b. Select the icon of switching destination media .Press



5.5.3 Copying/moving/deleting program/renaming a file

Copy, move and delete program, and rename a file.

a. Select an icon from the file operation menu. Press

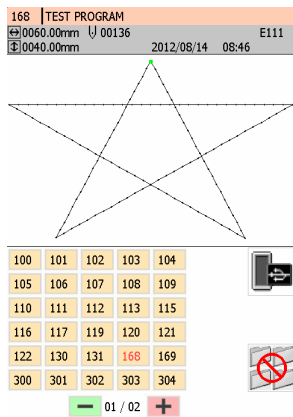

b. Select an icon from the file operation menu. Press

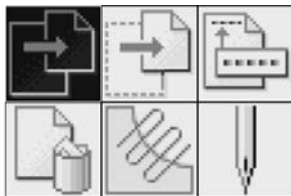

1) Copying program

Select

a. Specify a copy destination.

When a "A file with the same name exists. Do you overwrite it?" message is issued.

b、 To start overwriting, press To rename the file, press to change the program number

2) Moving program

Select .

a、 Specify a move destination.

When a "A file with the same name exists. Do you overwrite it?" message is issued

b、 To start overwriting, press . To rename the file, press to change the program number.

3) Changing a program number

Select .

a、 Input a program number. Press

b、 Select Press

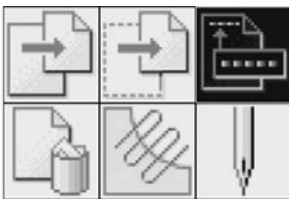

c、 Input the new program no.

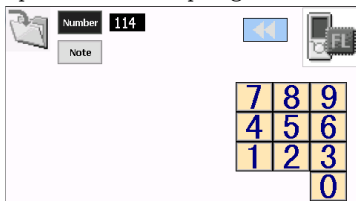

d、 Select to save the new comment.

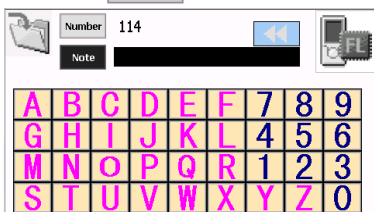

e、 Press to save the new comment.

4) Deleting program

Select .

When a "Cannot be redone after deletion. Are you sure?" message is issued.

To start deleting, press . To cancel deleting, press .

5) Editing a program

Select .

The screen is switched to the programming screen where you can edit the program you selected.

6) Carrying out sewing according to a program

Select .

The screen is switched to the PANEL screen where you can carry out sewing according to the selected program.

6. Sewing

⚠ CAUTION



Turn off the power switch at the following times.

If the foot switch is depressed by mistake, the sewing machine might start operating and cause injury.

- When threading the needle
- When replacing the bobbin and needle
- When not using the machine and when leaving the machine unattended



Do not touch any of the moving parts or press any objects against the machine while sewing, as this may result in personal injury or damage to the machine.

6.1 Sewing method

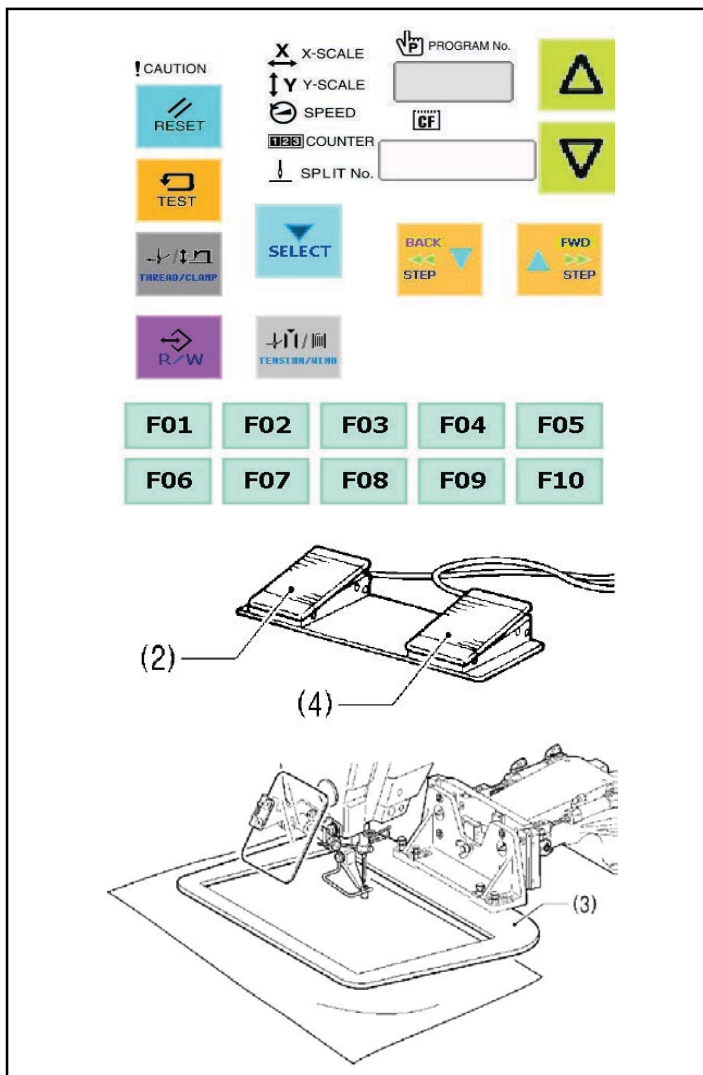

1. Turn on the power switch.
2. Press the Δ or ∇ key (1) to select the sewing program number that you would like to use.
3. Depress the work clamp switch (2) to lower the work clamp (3), and then depress the start switch (4).
 - The work clamp will move to the sewing start position.
 - Home position detection will be carried out immediately after the power switch is turned on.
4. Place the article to be sewn underneath the work clamp (3).
5. Depress the work clamp switch (2).
 - The work clamp (3) will drop.
6. Depress the start switch (4).
 - Sewing machine starts.
7. When sewing is complete, the thread will be trimmed and the work clamp (3) will rise.

Use a work clamp that hold the article being sewn firmly so that it does not slip. If using the standard work damp and feed plate and the article being sewn is slipping, take measures to stop the work clamp and feed plate from being slippery.

6.2 Using the STOP switch

If you press the STOP switch (1) while sewing or test feeding is in progress, the CAUTION indicator (2) will illuminate and the sewing machine will stop immediately.

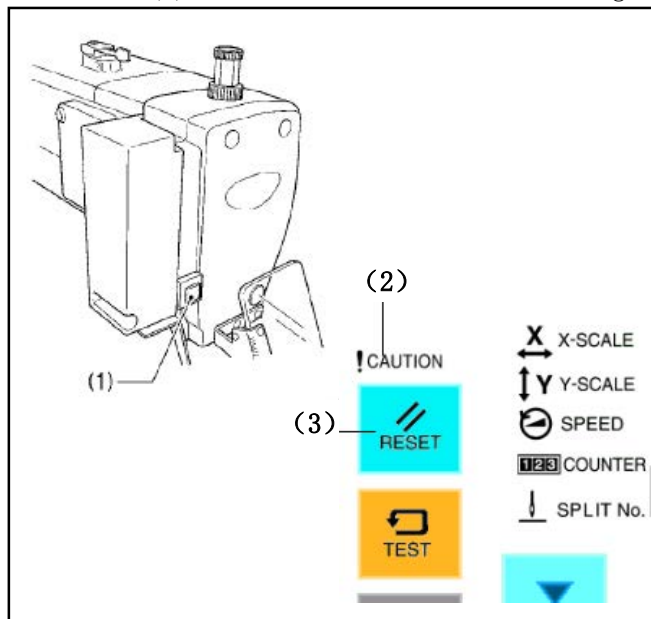

<Clearing>

1. Press the RESET key (3).
 - * The thread will be trimmed, and then the CAUTION indicator (2) will switch off and the buzzer will stop sounding.
2. If you do not wish to continue sewing, press the RESET key (3) once more.
 - * The program number will flash. Carry out preparation for the next sewing.

<Resuming sewing from a stopping point>

If you have pressed the STOP switch (1) at times when the thread breaks while sewing or the lower thread runs out, you can resume sewing from the point where the thread is ran out.

1		<p>Press the RESET key</p> <ul style="list-style-type: none"> • The thread will be trimmed, and then the CAUTION indicator will switch off and the buzzer will stop sounding.
2		<p>Press the ▼ key to return the work clamp to the position where sewing is to be continued.</p> <p>. When you press the ▼ key, the work clamp will move backward by one stitch, and when you press the ▲ key, it will move forward by one stitch. (It will move quicker if you keep the key pressed down.)</p>
3		<p>Depress the start switch (4).</p> <ul style="list-style-type: none"> • The sewing machine will start operating and sewing will start.

6.3 Using the thread wiper switch

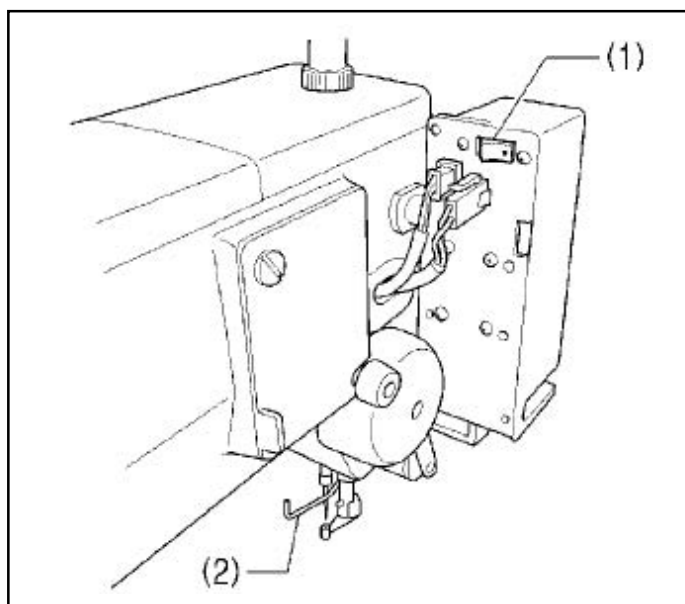

The thread wiper switch (1) can be used to turn the thread wiper (2) on and off (ON, OFF).

7. Maintenance



CAUTION

Turn off the power switch before carrying out cleaning.



If the foot switch is depressed by mistake, the sewing machine might start operating and cause injury.



Be sure to wear protective goggles and gloves when handling the lubricating oil and grease, so that they do not get into your eyes or onto your skin. Otherwise, inflammation can result.

Furthermore, do not drink or eat the lubricating oil or grease, which may cause diarrhea or vomiting.

Keep the oil out of the reach of children.

7.1 Cleaning the rotary hook

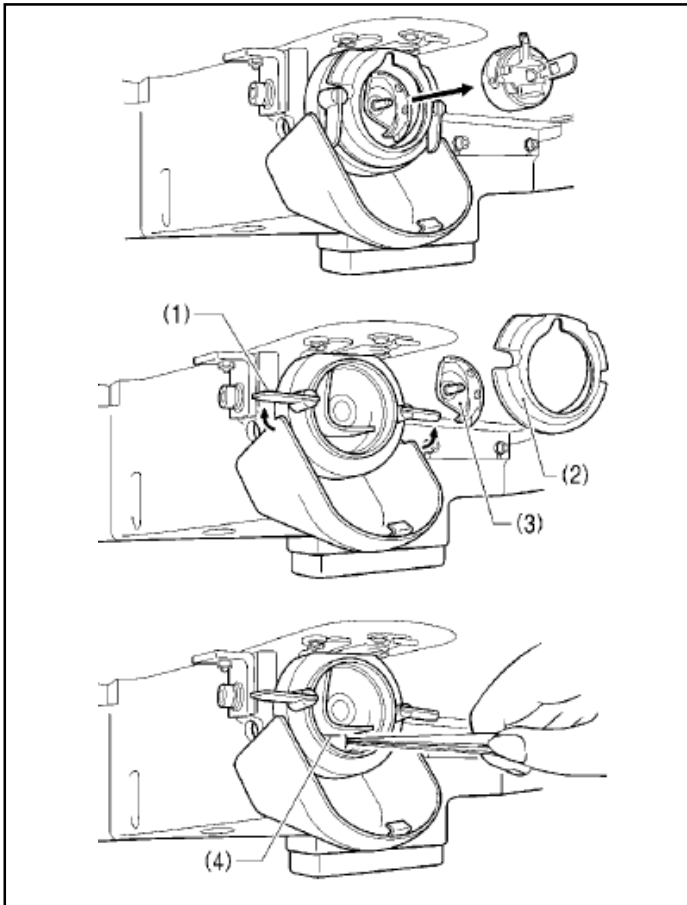

1. Pull the shuttle race cover downward to open it, and then remove the bobbin case.

2. Open the setting claw (1) in the direction indicated by the arrow, and then remove the shuttle race base (2) and the shuttle hook (3).

3. Clean all the dust and thread ends from around the driver (4), the top of the rotary hook thread guide and the shuttle race.

7.2 Waste oil

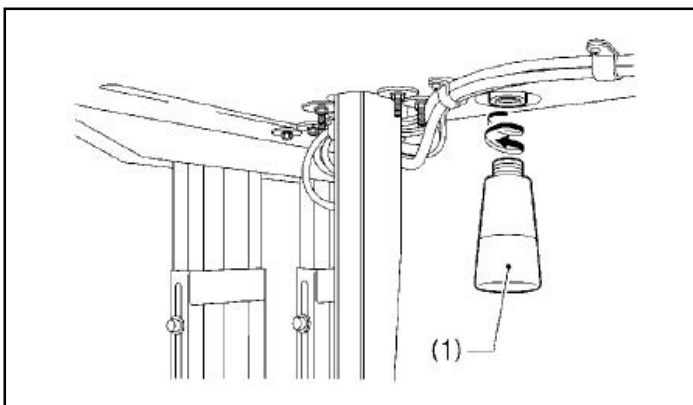

1) Remove and empty the oiler (1) whenever it is full.

2) After emptying oiler (1), screw it back into its original position.

*Properly dispose of the waste oil in compliance with waste oil disposal regulations.

7.3 Checking the regulator

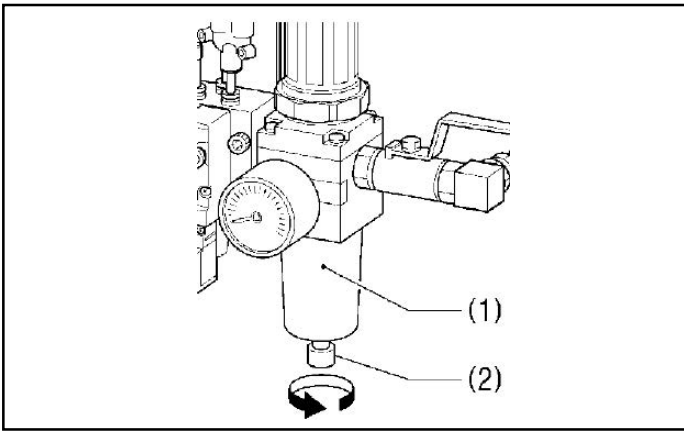

- 1) If water has been collected in the bottle of the regulator (1), turn the drain cock (2) in the direction indicated by an arrow to drain the water.
- 2) After draining the water, tighten the drain cock (2).

7.4 Cleaning the control box air inlet ports

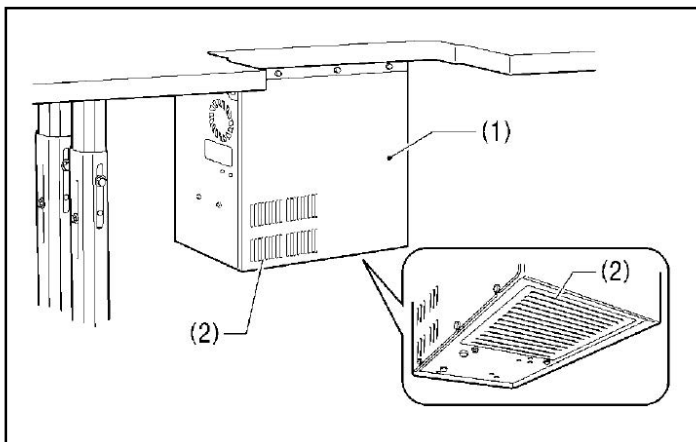

Use a vacuum cleaner to clean the filter in the air inlet ports (2) of the control box (1) at least once a month.

7.5 Cleaning the eye guard

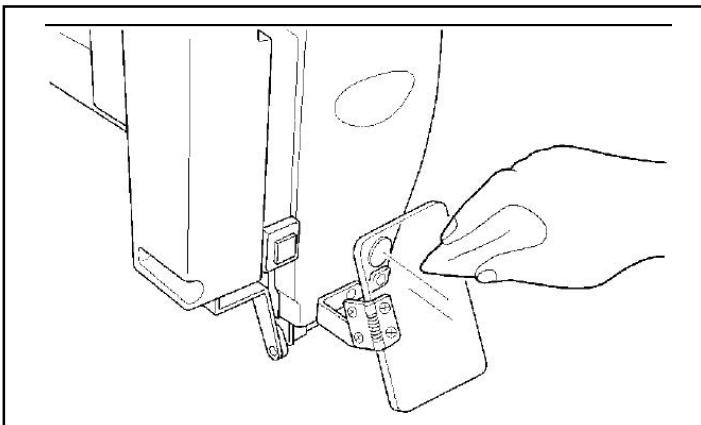

Wipe the eye guard clean with a soft cloth.
[Note]

Do not use solvents such as kerosene or thinner to clean the eye guard.

7.6 Checking the needle

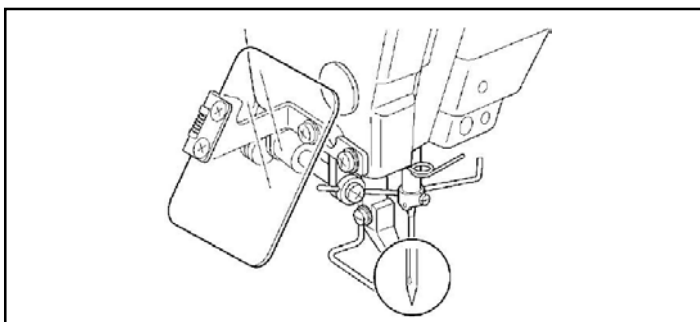



Always check that the tip of the needle is not broken or bent before starting sewing.

8. Standard Adjustments

CAUTION

 Maintenance and inspection of the sewing machine should only be carried out by a qualified technician.

 Entrust your dealer or a qualified electrician to carry out any maintenance and inspection of the electrical system.

 Turn off the power switch at the following times and unplug the power cord.

If the foot switch is depressed by mistake, the sewing machine might start operating and injury could result.

- Inspection, adjustment and maintenance
- Replacing consumable parts such as the rotary hook

 Disconnect the air hoses from the air supply and wait for the needle on the pressure gauge to drop to "0" before carrying out inspection, adjustment and repair of any parts which use the pneumatic equipment.



Hold the machine head with both hands when tilting it back or returning it to its original position.

In addition, do not subject the machine head to extra force while it is tilted back. If this is not observed, the machine head may become unbalanced and fall down, which would result in serious injury or damage to the sewing machine.



Be sure to wear protective goggles and gloves when handling the lubricating oil and grease, so that they do not get into your eyes or onto your skin. Otherwise, inflammation can result.

Furthermore, do not drink or eat the lubricating oil or grease, which may cause diarrhea or vomiting.

Keep the oil out of the reach of children.



If any safety devices have been removed, be absolutely sure to re-install them to their original positions and check that they operate correctly before using the machine.

8.1 Adjusting the thread take-up spring

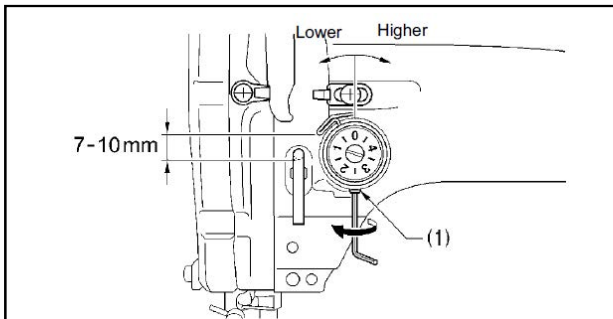

<Thread take-up spring height>

Loosen the set screw (1) and turn the adjuster to adjust.

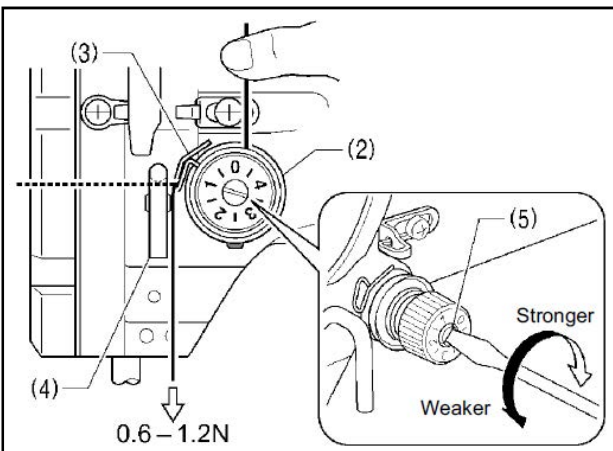

<Thread take-up spring tension>

- 1) Press the upper thread slightly above the tension bracket (2) with a finger to stop the thread spooling out.
- 2) Pull the upper thread downward so that the thread take-up spring (3) is extended to the same height as the base of the thread guide arm (4), and then measure the tension of the thread take-up spring (3).
- 3) Use a screwdriver to turn the tension stud (5) in order to adjust the tension of the thread take-up spring.

[NOTE]

If the thread tension spring is not adjusted correctly, the upper thread trailing length will be uneven after thread trimming.

8.2 Adjust arm thread guide

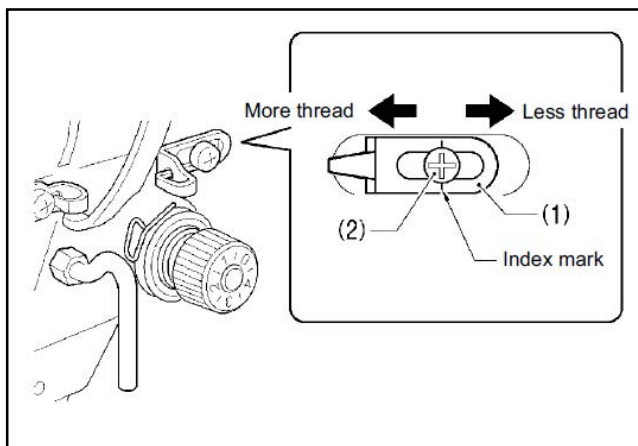

The standard position of arm thread guide (1) is when the screw (2) is aligned with the index mark. Loosen the screw (2) and move arm thread guide (1) to adjust.

- When sewing heavy material, move arm thread guide (1) to the left. (The thread take-up amount will become greater.)
- When sewing heavy material, move arm thread guide (1) to the right. (The thread take-up amount will become less.)

8.3 Adjusting the needle bar height

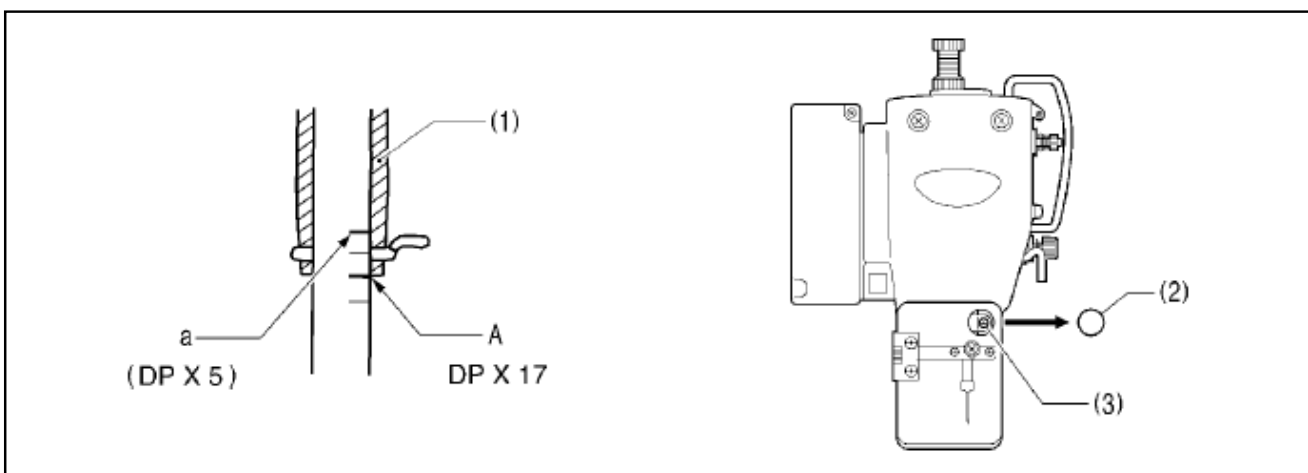

Turn the machine pulley to move the needle bar to the lowest position. Then remove the rubber plug (2), loosen the screw (3) and then move the needle bar up or down to adjust so that the second reference line from the bottom of the needle bar (reference line A) is aligned with the lower edge of the needle bar bush (1).

* If using a DPX5 needle, use the highest reference line (reference line a).

8.4 Adjusting the needle bar lift amount

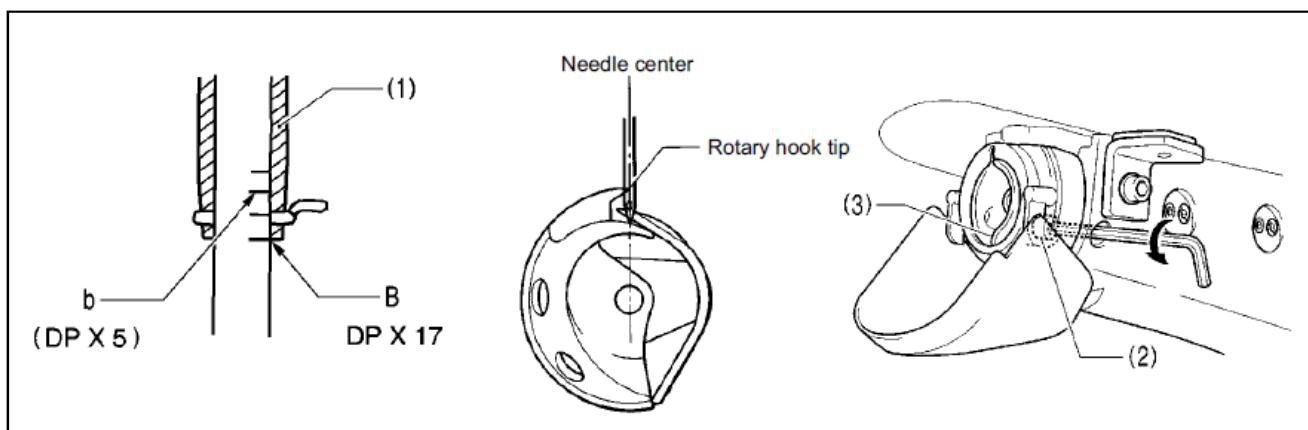

Turn the machine pulley to raise the needle bar from the lowest position until the lowest reference line on the needle bar (reference line B) is aligned with the lower edge of the needle bar bush (1), and then loosen the bolt (2) and move the driver (3) so that the tip of the rotary hook is aligned with the center of the needle.

*If using a DPX5 needle, use the second reference line from the top of the needle bar (reference line b).

8.5 Adjusting the driver needle guard

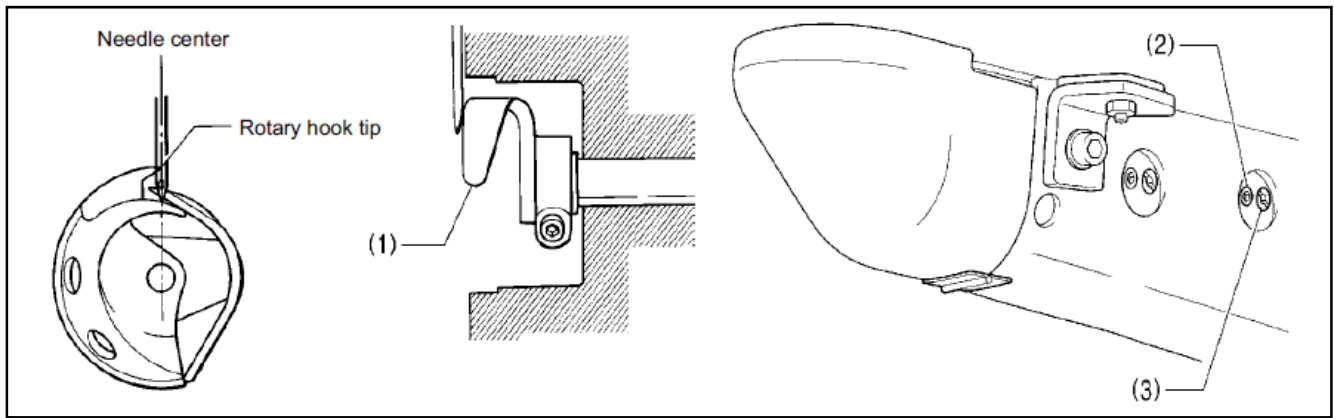

Turn the machine pulley to align the tip of the rotary hook with the center of the needle, and then loosen the set screw (2) and turn the eccentric shaft (3) to adjust so that the driver needle guard (1) is touching the needle.

[NOTE]

If it crosses the needle more than necessary, it will place a load on the needle, or it may cause poor thread tension. Furthermore, if it does not cross the needle at all, the tip of the rotary hook will interfere with the needle and skipped stitches may occur.

8.6 Adjusting the needle clearance

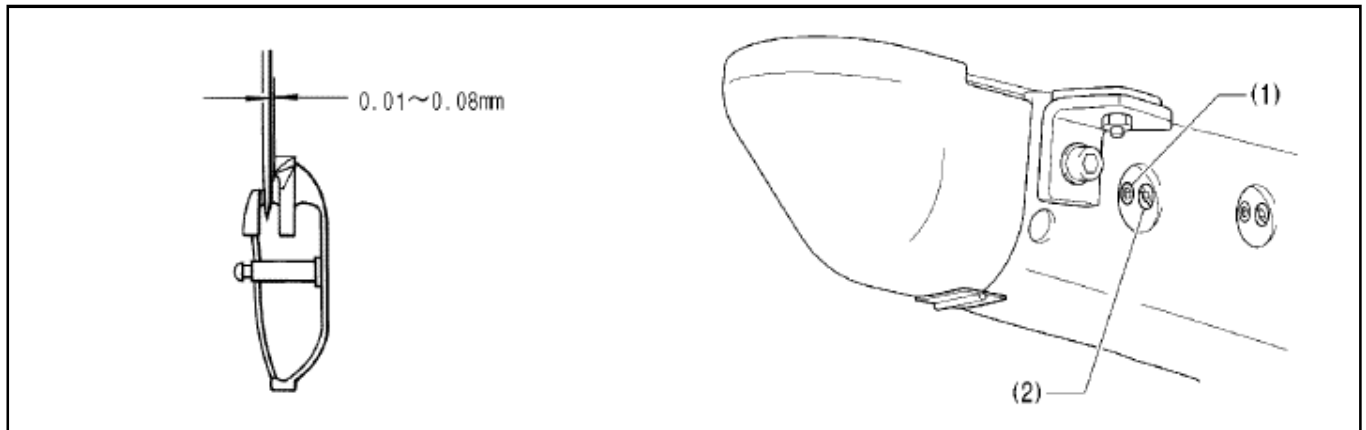

Turn the machine pulley to align the tip of the rotary hook with the center of the needle, and then loosen the set screw (1) and turn the adjusting stud (2) to adjust so that the clearance between the needle and the rotary hook is 0.01 - 0.08 mm.

8.7 Adjusting the shuttle race thread guide

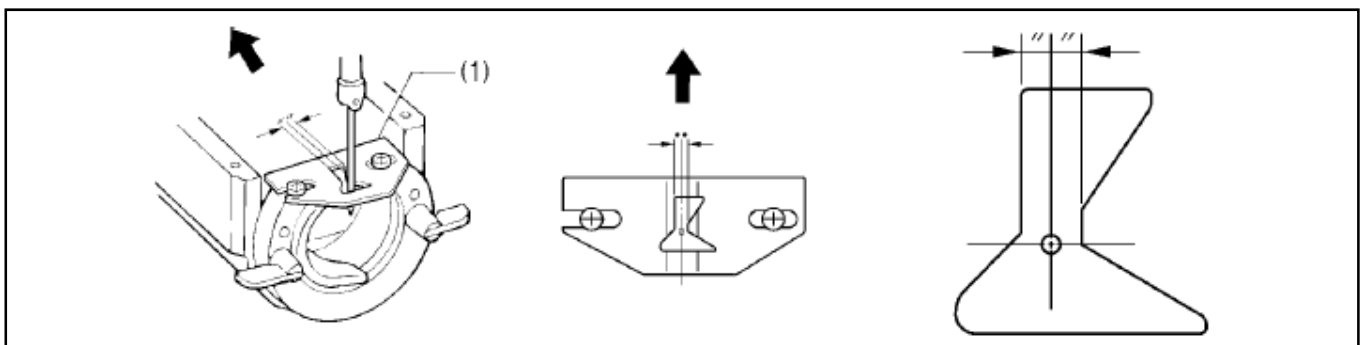

Install the shuttle race thread guide (1) by pushing it in the direction of the arrow so that the needle groove of thread guide (1) is aligned with the center of the needle plate hole.

[Note]

If the shuttle race thread guide (1) is in the wrong position, thread breakages, soiled thread or tangling of the thread may occur.

The position of the shuttle race thread guide (1) is adjusted at the time of shipment from the factory. It should not be changed if possible.

8.8 Adjusting the rotary hook lubrication amount

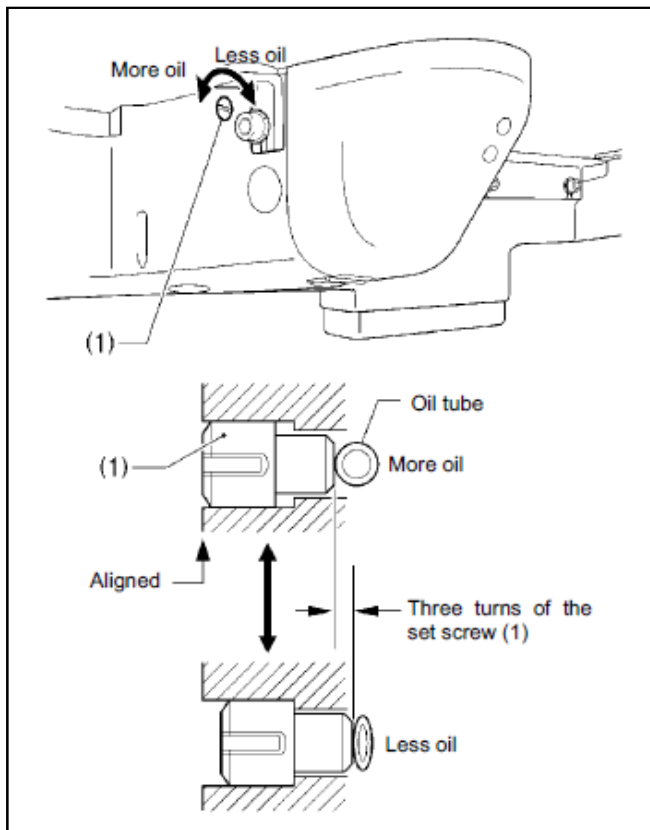

<Adjusting by changing the pressure on the oil tube>

The optimum position is when the head of the set screw (1) is aligned with the edge of the bed. The rotary hook lubrication amount can be adjusted within three turns to the right from that position.

- If the set screw (1) is turned clockwise, the lubrication amount becomes smaller.
- If the set screw (1) is turned counterclockwise, the lubrication amount becomes greater.

* If you would like the lubrication amount to be increased further from the position the head of the set screw (1) is aligned with the edge of the bed, use the following method to make the adjustment.

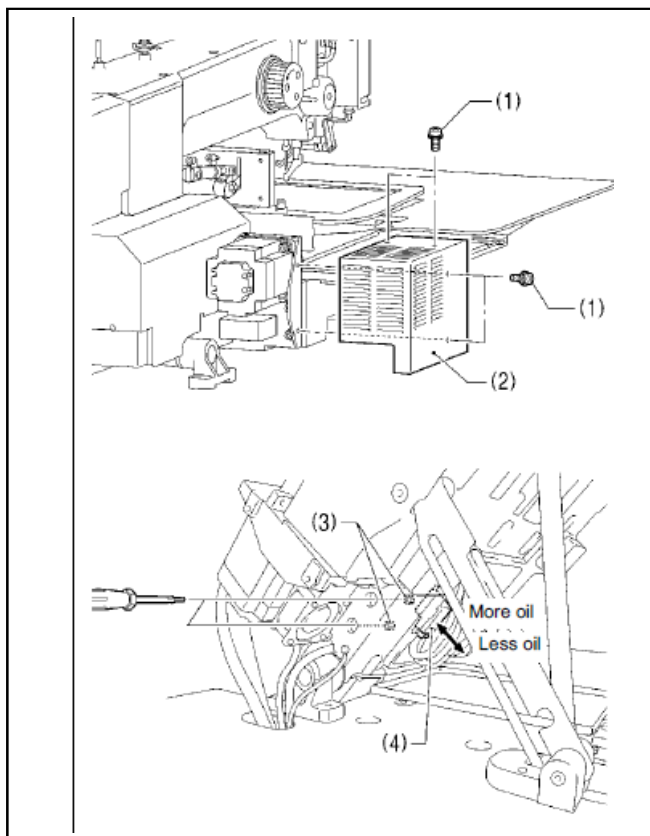

<Adjusting by changing the amount of oil supplied from the sub-tank>

- 1) Remove the four screws (1), and then remove the X motor cover (2).
- 2) Tilt back the machine head.
- 3) Insert a screwdriver into the holes in the left side of the sewing machine bed and loosen the two bolts (3).
- 4) Move the sub-tank (4) up or down to adjust its position, and then tighten the two bolts (3).

- If the position of the sub-tank (4) is raised, the lubrication amount will increase.
- If the position of the sub-tank (4) is lowered, the lubrication amount will decrease.

- 5) Return the machine head to its original position.
- 6) Install the X motor cover (2) with the four screws (1).

8.9 Adjusting the position of the movable knife

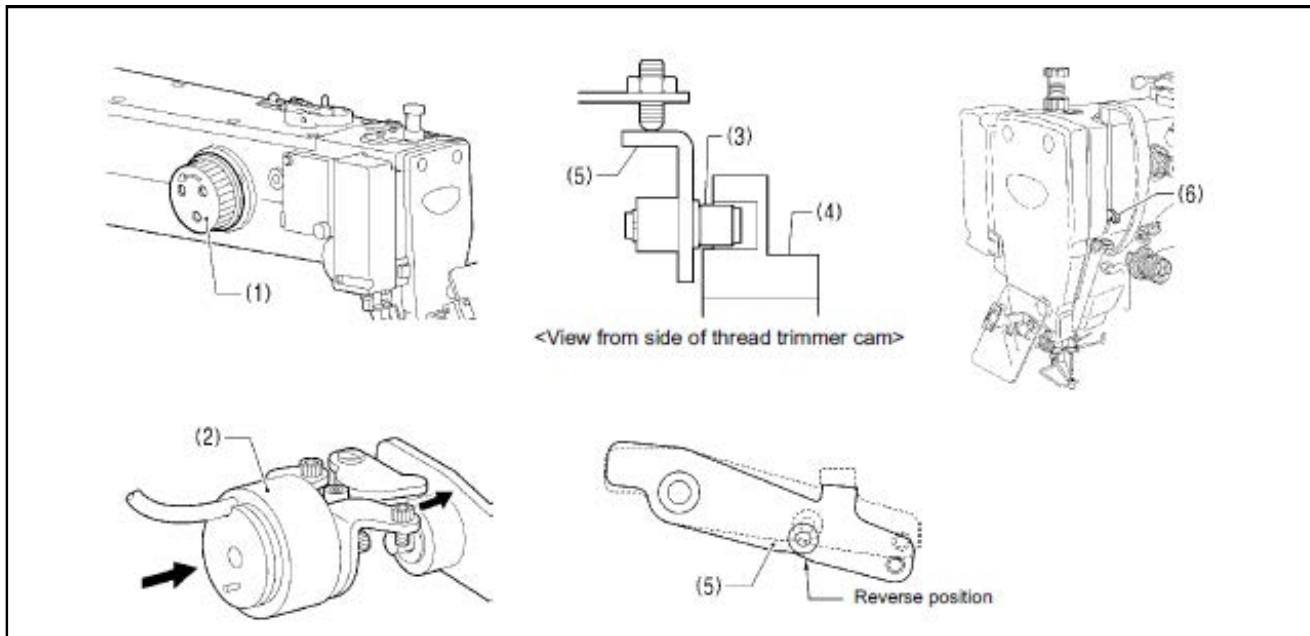

- 1) Open the top cover and tilt back the machine head.
- 2) Turn the pulley (1) by hand to lower the needle bar to its lowest position, and push the thread trimmer solenoid (2) as far as it will go.
- 3) With the collar (3) inserted into the groove of the thread trimmer cam (4), turn the pulley (1) by hand to set the driving lever (5) to the reverse position (when the thread take-up (6) is close to its lowest position).

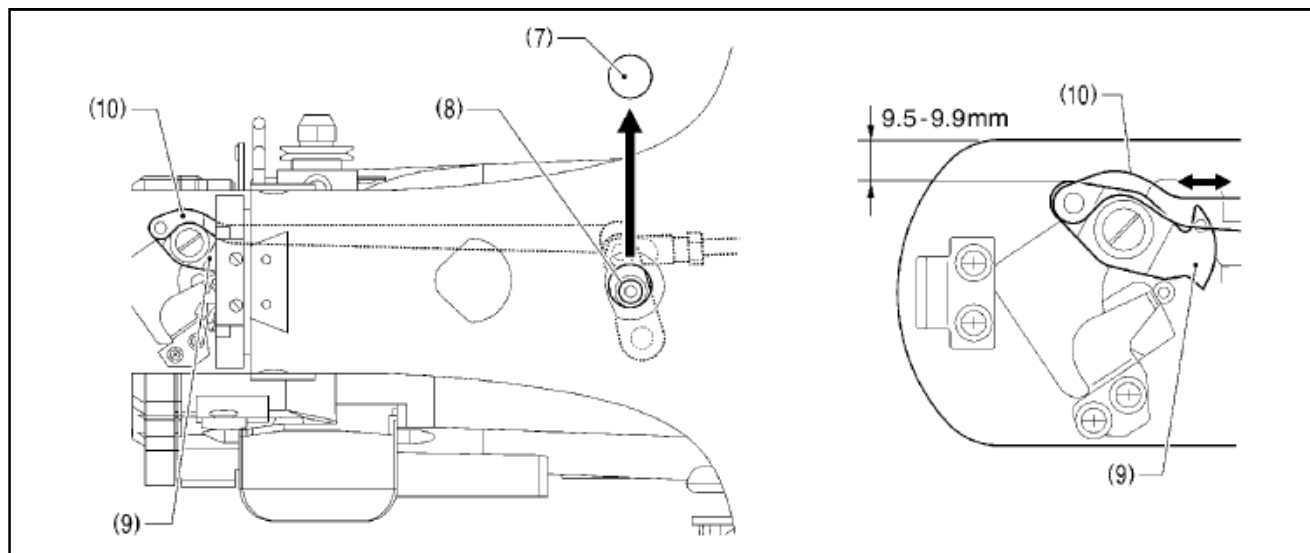

- 4) Remove the rubber cap (7).
- 5) Loosen the bolt (8).
- 6) Move the movable knife connecting plate (10) back and forth to adjust so that the distance from the ridge on the right side of the needle plate to the ridge on the movable knife (9) is 9.5-9.9 mm.
- 7) After tightening the bolt (8), check the above position once more.

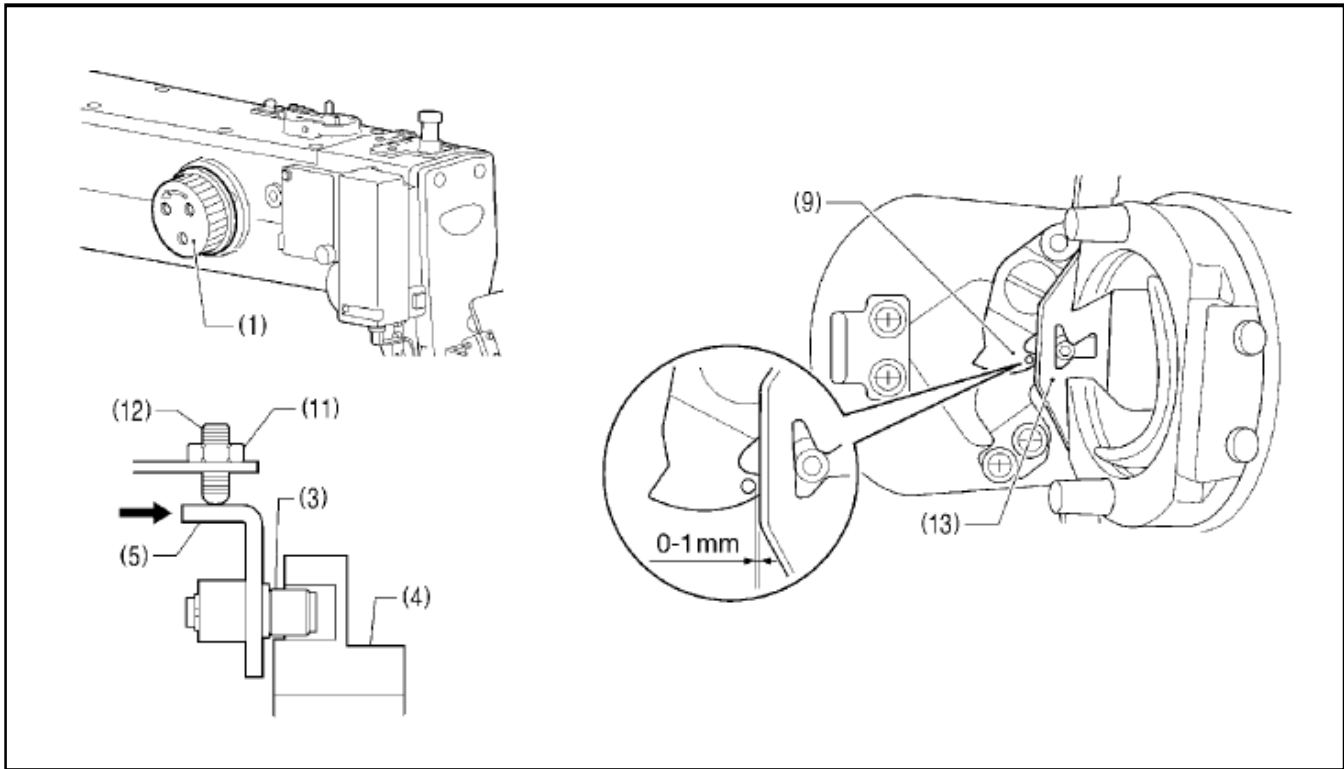

8) Turn the pulley (1) by hand to move the needle bar to its lowest position.

9) Loosen the nut (11), tighten the set screw (12) until the collar (3) is touching the inside of the groove in the thread trimmer cam (4), and then turn it back in the counterclockwise direction by approximately 1/4 of a turn.

10) Tighten the nut (11), and then check that the collar (3) is not touching the inside of the groove in the thread trimmer cam (4). In addition, push the driving lever (5) by hand toward the thread trimmer cam until the collar (3) touches the groove of the thread trimmer cam (4), and then check that the driving lever (5) returns smoothly to its original position when it is released.

11) Check that there is a gap of about 0-1 mm between the outside of the hole in the movable knife (9) and the ridge line on the shuttle race thread guide (13) when there is still play between the parts.

8.10 Adjusting the thread wiper

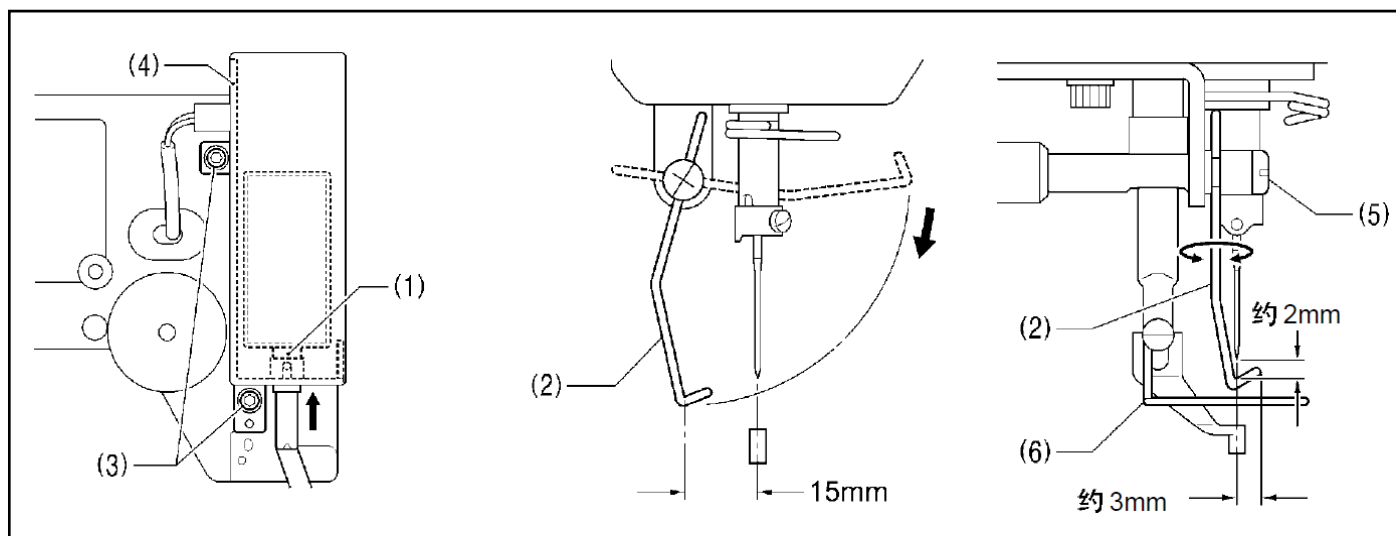

1) Loosen the two screws (3) and shift the entire solenoid setting plate (4) up or down to adjust so that the thread wiper (2) is 15mm in front of the needle center when the plunger (1) of the thread wiper solenoid is driven to the full stroke.

2) Loosen the screw (5) and adjust the position of the thread wiper (2) so that the distance from the thread wiper to the tip of the needle is approximately 2 mm and the tip of the thread wiper (2) is approximately 3 mm from the center of the needle when the thread wiper (2) passes below the needle during operation.

[NOTE]

Check that the thread wiper (2) does not touch the finger guard (6).

8.11 Presser foot installation position

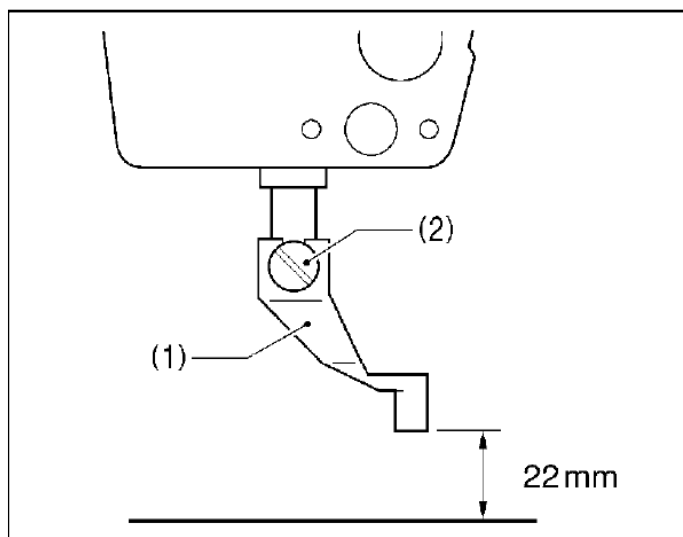

Install the presser foot (1) with the screw (2) so that the distance from the bottom of the presser foot to the top of the needle plate is 22mm when the sewing machine is stopped and the presser foot (1) is raised.

9. Table of error codes



Wait at least 5 minutes after turning off the power switch and disconnecting the power cord from the wall outlet before opening the cover of the control box. Touching areas where high voltages are present can result in severe injury.

If a malfunction should occur with the sewing machine, a buzzer will sound and an error code will appear in the display window. Follow the remedy procedure to eliminate the cause of the problem.

Switch-related errors

Code	Cause and remedy
E010	Stop switch was pressed. Press the RESET key to clear the error.
E011	Stop switch was pressed. Press the RESET key to clear the error. Press the ▼ key to move the work clamp so that you can continue sewing.
E015	The stop switch was still being pressed, or there is a problem with the stop switch connection. Turn off the power, and then check that connector P13 on the main P.C. board is properly connected.
E016	Problem with the stop switch connection. Turn off the power, and then check that connector P13 on the main P.C. board is properly connected.
E025	The power was turned on while the start switch was still being depressed, or the start switch was depressed without the work clamp being lowered. If the power has been turned on while the start switch was still depressed, turn off the power and check the start switch. If the start switch was depressed without lowering the work clamp, depress the work clamp switch to lower the work clamp.
E035	The work clamp switch is depressed. Turn off the power, and then check the work clamp switch.
E036	A foot switch that does not match specifications is connected, or work clamp mode has not been set correctly. Use a foot switch that matches specifications, or initialize the memory switch settings.
E050	Machine head tilting was detected after the power was turned on. Turn off the power, and then return the machine head to its original position. Check that connector P9 on the main P.C. board is properly connected.
E051	Machine head tilting was detected while the sewing machine was operating. Turn off the power, and then check that connector P9 on the main P.C. board is properly connected.
E055	Machine head tilting was detected when the power was turned on. Turn off the power, and then return the machine head to its original position. Check that connector P9 on the main P.C. board is properly connected.
E065	An operation panel key was still being pressed when the power was turned on, or key is faulty. Turn off the power and check the operation panel.

Upper shaft motor-related errors

Code	Cause and remedy
E110	Needle up stop position error. Turn the machine pulley until the point where the error display disappears.
E111	Upper shaft did not stop at the needle up stop position when the sewing machine stopped. Turn the machine pulley until the point where the error display disappears.
E120	Needle drop signal could not be detected. Turn off the power, and then check the synchronizer connection.
E121	Thread trimming was not completed. Turn off the power, and then check if the cutting edges of the fixed knife and movable knife are damaged or worn.

(Continued on next page)

Code	Cause and remedy
E130	Sewing machine motor stopped due to a problem, or synchronizer is faulty. Turn off the power, and then turn the machine pulley and check if the sewing machine has locked up. Check that connectors P4 and P5 on the power supply motor P.C. board are properly connected.
E131	Synchronizer is faulty. Turn off the power, and then check that connector P5 on the power supply motor P. C. board is properly connected.
E132	Problem detected with sewing machine motor operation. Turn off the power, and then check that connector P4 on the power supply motor P.C. board is properly connected.
E133	Sewing machine motor stopping position is incorrect. Turn off the power, and then check that connector P5 on the power supply motor P.C. board is properly connected.
E150	Sewing machine motor is overheating, or temperature sensor is faulty. Turn off the power, and then check the sewing machine motor. (When sewing data with a small number of stitches (15 stitches or less) is sewn repeatedly (short cycle operation), the upper shaft motor may overheat and the "E150" error code may be generated.)

Feed mechanism-related errors

Code	Cause and remedy
E200	X-feed motor home position cannot be detected. Problem with X -feed motor or poor X home position sensor connection. Turn off the power, and then check that connector P10 on the PMD P.C. board and connector P20 on the main P.C. board are properly connected.
E201	X-feed motor stopped due to a problem. Turn off the power, and then check if there are any problems in the X-feed direction.
E202	Problem with X-feed motor or Y-feed motor home position adjustment data. Re-adjust the home position.
E204	X feed motor stopped abnormally during sewing. Turn off the power, and then check if there are any problems in the X-feed direction.
E205	X feed motor stopped abnormally while moving to the sewing start position. Turn off the power, and then check if there are any problems in the X-feed direction.
E206	X feed motor stopped abnormally during test feeding. Turn off the power, and then check if there are any problems in the X-feed direction.
E207	X feed motor stopped abnormally during programming. Turn off the power, and then check if there are any problems in the X-feed direction.
E210	Y-feed motor home position cannot be detected. Problem with Y-feed motor or poor Y home position sensor connection. Turn off the power, and then check that connector P8 on the PMD P.C. board and connector P4 on the main P.C. board are properly connected.
E211	Y-feed motor stopped due to a problem. Turn off the power, and then check if there are any problems in the Y-feed direction.
E214	Y feed motor stopped abnormally during sewing. Turn off the power, and then check if there are any problems in the Y-feed direction.
E215	Y feed motor stopped abnormally while moving to the sewing start position. Turn off the power, and then check if there are any problems in the Y-feed direction.
E216	Y feed motor stopped abnormally during test feeding. Turn off the power, and then check if there are any problems in the Y-feed direction.
E217	Y feed motor stopped abnormally during programming. Turn off the power, and then check if there are any problems in the Y-feed direction.

Work clamp-related errors

Code	Cause and remedy
E300	Work clamp home position cannot be detected. Problem with work clamp motor or poor work clamp home position sensor connection. Turn off the power, and then check that connector P3 on the PMD P.C. board and connector P5 on the main P.C. board are properly connected.
E301	Intermittent presser foot raised or lowered position cannot be detected. Turn off the power, and then check if there are any problems in the intermittent presser foot vertical direction.
E303	Problem with work clamp motor home position adjustment data. Re-adjust the home position.

Communication and memory-related errors

Code	Cause and remedy
E401	Connection communication error with power supply motor P. C. board detected when power was turned on. Turn off the power, and then check that connector P6 on the power supply motor P.C. board and connector P17 on the main P.C. board are properly connected.
E402	Communication error with programmer detected when power is turned on. Turn off the power, and then check that connector P7 on the main P.C. board is properly connected.
E403	Connection error with PMD P. C. board detected when power was turned on. Turn off the power, and then check that connector P1 on the PMD P.C. board is properly connected.
E410	Communication error with main P. C. board detected. Turn off the power, and then turn it back on again.
E411	Communication error with power supply motor P. C. board detected. Turn off the power, and then turn it back on again.
E412	Communication error with programmer detected. Turn off the power, and then turn it back on again.
E413	Communication error with PMD P. C. board detected. Turn off the power, and then turn it back on again.
E420	No CF card is inserted.
E421	Program contents are incorrect and cannot be used, or no data. Check that the CF card or floppy disk contains data with this program number.
E422	Error occurred while reading the CF card or floppy disk. Check the data on the CF card or floppy disk.
E424	Insufficient free space on CF card. Use a different CF card.
E425	Error occurred while writing to the CF card or floppy disk. Use the specified type of CF card. Check if the floppy disk is write-protected and if it has enough free space.
E426	R/W key has not been pressed. Press the R/W key to load the data.
E427	CF card or floppy disk does not contain any data with this program number. Check the program number. Data that has already been loaded into internal memory can be used without having to press the R/W key again.
E430	Data cannot be backed up to main P.C. board. Turn off the power, and then turn it back on again.
E440	Data memory error on main P.C. board. Turn off the power, and then turn it back on again.
E450	Model selection cannot be read from the machine head memory. Turn off the power and check that connector P3 on the power supply motor P.C. board is properly connected.
E451	Data cannot be backed up to machine head memory. Turn off the power, and then turn it back on again.
E452	Machine head memory is not connected. Turn off the power, and then check that connector P3 on the power supply motor P.C. board is properly connected.
E474	Internal memory is full and copying is not possible. Clear the sewing data.

Data editing-related errors

Code	Cause and remedy
E500	The enlargement ratio setting caused the sewing data to extend outside the sewing area. Set the enlargement ratio again.
E501	Sewing data that exceeds the sewing machine's sewing area was loaded. Check the size of the sewing data.
E502	The enlargement ratio caused the data pitch to exceed the maximum pitch of 12.7 mm. Set the enlargement ratio again.
E510	Invalid code in sewing data. Reload the data from the CF card or floppy disk.
E511	No end code has been input into sewing data. Input an end code, or change the program number.
E512	Number of stitches exceeds allowed maximum.
E520	Extended option output number already exists. Change the extended option output number. If not using the extended option output, initialize the data to clear the extended option output data.
E530	Changing program number is prohibited.

P.C. board-related errors

Code	Cause and remedy
E700	Abnormal rise in power supply voltage. Turn off the power and check the input voltage.
E701	Abnormal rise in sewing machine motor drive voltage. Turn off the power, and then check the voltage.
E705	Abnormal drop in power supply voltage. Turn off the power and check the input voltage.
E710	Abnormal current detected in sewing machine motor. Turn off the power, and then check if there are any problems with the sewing machine.
E711	Abnormal current detected in X-feed motor. Turn off the power, and then check if there are any problems in the X-feed direction.
E712	Abnormal current detected in Y-feed motor. Turn off the power, and then check if there are any problems in the Y-feed direction.
E713	Abnormal current detected in work clamp motor. Turn off the power, and then check if there are any problems with the X-feed mechanism, Y-feed mechanism or work clamp lifter.
E730	External error input (AIRSW) detected. Turn off the power, and then check the air pressure.
E740	Control box cooling fan does not operate. Turn off the power, and then check if the cooling fan is blocked with scraps of thread. Check that connector P22 on the main P.C. board is properly connected.
E741	X-feed motor cooling fan does not operate. Turn off the power, and then check if the cooling fan is blocked with scraps of thread. Check that connector P10 on the main P.C. board is properly connected.
E742	Y-feed motor cooling fan does not operate. Turn off the power, and then check if the cooling fan is blocked with scraps of thread. Check that connector P10 on the main P.C. board is properly connected.

If an error code that is not listed above appears or if carrying out the specified remedy does not solve the problem, contact the place of purchase.

10. Troubleshooting

- Please check the following points before calling for repairs or service.
- If the following remedies do not fix the problem, turn off the power switch and consult a qualified technician or the place of purchase.

CAUTION



Turn off the power switch and disconnect the power cord before carrying out troubleshooting.
If the foot switch is depressed by mistake, the sewing machine might start operating and injury could result.

Problem	Cause	Remedy
Work clamp does not lift.	Work clamp moves stiffly.	Apply a suitable amount of grease to the sliding parts of the work clamp slider.
Work clamp does not drop.	Air tube of presser lifter cylinder is bent or damaged.	Straighten the bend in the tube or replace the tube.
Work clamp lift amount is incorrect.	Work clamp lifter lever position is incorrect.	Adjust the position of the work clamp lifter lever.
Work clamp does not lift to the maximum height.	Cylinder joint position is incorrect.	Adjust the position of the cylinder joint.
Thread wiper does not operate correctly.	The thread wiper is obstructing the needle.	Adjust the height of the thread wiper.
		Adjust the stroke of the thread wiper.
	Thread wiper position is incorrect.	Adjust the stroke of the thread wiper.
Lower thread winds to one side.	Bobbin winder tension assembly height is incorrect.	Adjust the height of the bobbin winder tension assembly.
Lower thread winding amount is incorrect.	Bobbin presser position is incorrect.	Adjust the position of the bobbin presser.
Thread slips out of the needle.	Stitches being skipped at the sewing start.	Refer to "Skipped stitches occur".
	Upper thread trailing length is uneven.	Adjust the sub-tension.
	Position of shuttle race thread guide is incorrect	Adjust the position of the shuttle race thread guide.

Problem	Cause	Remedy
Upper thread breaks.	Upper thread tension is too strong.	Adjust the upper thread tension.
	Needle is incorrectly installed.	Install the needle correctly.
	Thread is too thick for the needle.	Select a thread that matches the needle.
	Thread take-up spring tension and height are incorrect.	Adjust the tension and height of the thread take-up spring.
	Damage or burring of the rotary hook, needle hole plate or needle.	Repair or replace the problem part.
	Thread breaking from heat (Synthetic thread)	Use a cooling tank.
	Thread is threaded incorrectly.	Thread the thread correctly.
Lower thread breaks.	Lower thread tension is too strong.	Adjust the lower thread tension.
	Damage to corners of needle hole plate or bobbin case.	Repair or replace the problem part.
Skipped stitches occur.	Clearance between needle and rotary hook tip is too great.	Adjust the needle clearance.
	Needle and rotary hook timing is incorrect.	Adjust the needle bar lift amount.
	The driver is covering the needle more than necessary.	Adjust the driver needle guard.
	Needle is bent.	Replace the needle.
	Needle is incorrectly installed.	Install the needle correctly.
Needle is broken.	Clearance between needle and rotary hook tip is too great.	Adjust the needle clearance.
		Adjust the needle bar lift amount.
	Needle is bent.	Replace the needle.
	Needle deflection	Select a needle that is suitable for the sewing conditions. Reduce the sewing speed.
	Needle is too thin.	Select a needle that is suitable for the sewing conditions.
Thread jamming.	Thread take-up spring tension and height are incorrect.	Adjust the tension and height of the thread take-up spring.
	Needle and rotary hook timing is incorrect.	Adjust the needle bar lift amount.
	Shuttle race thread guide is not separating the threads.	Adjust the position of the shuttle race thread guide.

Problem	Cause	Remedy
Upper thread is not trimmed.	Movable knife is not cutting cleanly.	Replace with a new one.
	Fixed knife is not cutting cleanly.	Sharpen the fixed knife or replace it with a new one.
	Movable knife is not picking up the upper thread.	Adjust the position of the shuttle race thread guide.
		Adjust the needle bar lift amount.
	Movable knife is not picking up the upper thread because the last stitch is being skipped.	Refer to "Skipped stitches occur".
	Movable knife position is incorrect.	Adjust the position of the movable knife.
Sub-tension is too weak.	Turn the sub-tension nut to adjust the tension.	
Poor stitch finish on underside of material.	Shuttle race thread guide is not separating the threads enough.	Adjust the position of the shuttle race thread guide.
	Incorrect tightening of the upper thread	Adjust the upper thread tension.
	Upper thread trailing length is uneven.	Adjust the sub-tension.
Incorrect tightening of the thread	Upper thread tension is too weak.	Adjust the upper thread tension.
	Lower thread tension is too weak.	Adjust the lower thread tension.
	Thread take-up spring tension and height are incorrect.	Adjust the tension and height of the thread take-up spring.
	Position of arm thread guide R is incorrect.	Adjust the position of arm thread guide R.
Upper thread trailing length is uneven.	Thread take-up spring tension and height are incorrect.	Adjust the tension and height of the thread take-up spring.
	Sub-tension is too weak.	Turn the sub-tension nut to adjust the tension.
	Fixed knife is not cutting cleanly.	Sharpen the fixed knife or replace it with a new one.
Sewing machine does not operate when the power is turned on and the foot switch is depressed.	Safety switch does not work.	Check if the safety switch cord is disconnected.
		Adjust the position of the safety switch.
		If the safety switch is malfunctioning, replace it with a new one.

TC6040

ELECTRONIC PATTERN SEWING MACHINE



This machine may only be operated by adequately trained operators only after having completely read and understood the instruction manual.

Parts are subject to changes in design without prior notice.



VETRON TYPICAL EUROPE GmbH
Clara-Immerwahr-Str. 6
67661 Kaiserslautern, Germany
Tel.: +49 6301 320 75-0
Fax: +49 6301 320 75-11

info@vetrontypical.com
www.vetrontypical.com

TY-TC6040- EN-07/2021