

TC-12080

OPERATION MANUAL & PARTS LIST



FULLY AUTOMATIC SEWING CONTROL SYSTEM
GENERATION-II



TYPICAL



SAFETY INSTRUCTIONS

[1] Safety indications and their meanings

This instruction manual and the indications and symbols that are used on the machine itself are provided in order to ensure safe operation of this machine and to prevent accidents and injury to yourself or other people.

The meanings of these indications and symbols are given below.

Indications

 DANGER	The instructions which follow this term indicate situations where failure to follow the instructions will result in death or serious injury.
 CAUTION	The instructions which follow this term indicate situations where failure to follow the instructions could cause injury when using the machine or physical damage to equipment and surroundings.

Symbols



..... This symbol () indicates something that you should be careful of. The picture inside the triangle indicates the nature of the caution that must be taken.
(For example, the symbol at left means “beware of injury”.)



..... This symbol () indicates something that you must not do.



..... This symbol () indicates something that you must do. The picture inside the circle indicates the nature of the thing that must be done.
(For example, the symbol at left means “you must make the ground connection”.)

[2] Notes on safety

DANGER



Wait at least 5 minutes after turning off the power switch and disconnecting the power cord from the wall outlet before opening the cover of the control box. Touching areas where high voltages are present can result in severe injury.

CAUTION

Environmental requirements



Use the sewing machine in an area which is free from sources of strong electrical noise such as electrical line noise or static electric noise. Sources of strong electrical noise may cause problems with correct operation.



Any fluctuations in the power supply voltage should be within $\pm 10\%$ of the rated voltage for the machine. Voltage fluctuations which are greater than this may cause problems with correct operation.



The power supply capacity should be greater than the requirements for the sewing machine's power consumption. Insufficient power supply capacity may cause problems with correct operation.



The pneumatic delivery capability should be greater than the requirements for the sewing machine's total air consumption. Insufficient pneumatic delivery capability may cause problems with correct operation.



The ambient temperature should be within the range of 5°C to 35°C during use. Temperatures which are lower or higher than this may cause problems with correct operation.



The relative humidity should be within the range of 45% to 85% during use, and no dew formation should occur in any devices. Excessively dry or humid environments and dew formation may cause problems with correct operation.



In the event of an electrical storm, turn off the power and disconnect the power cord from the wall outlet. Lightning may cause problems with correct operation.

Installation



Machine installation should only be carried out by a qualified technician.



Contact your Brother dealer or a qualified electrician for any electrical work that may need to be done.



The sewing machine weighs approximately 540 kg. Use equipment such as a crane or hoist when installing the machine head and adjusting the height of the table. If you try to lift the machine head yourself, it may cause injuries such as back injury.



Do not connect the power cord until installation is complete. If the foot switch is depressed by mistake, the sewing machine might start operating and injury could result.



Hold the machine head with both hands when tilting it back or returning it to its original position. In addition, do not subject the machine head to extra force while it is tilted back. If this is not observed, the machine head may become unbalanced and fall down, and serious injury or damage to the sewing machine may result.



Be sure to connect the ground. If the ground connection is not secure, you run a high risk of receiving a serious electric shock, and problems with correct operation may also occur.



All cords should be secured at least 25 mm away from any moving parts. Furthermore, do not excessively bend the cords or secure them too firmly with staples, otherwise there is the danger that fire or electric shocks could occur.



Install the safety covers to the machine head and motor.



If using a work table which has casters, the casters should be secured in such a way so that they cannot move.











Use a table with a height of 84 cm or less. If the table is too high, the machine head may become unbalanced and fall down, and serious injury or damage to the sewing machine may result.





Be sure to wear protective goggles and gloves when handling the lubricating oil and grease, so that they do not get into your eyes or onto your skin. If the oil and grease get into your eyes or onto your skin, inflammation can result. Furthermore, do not drink or eat the lubricating oil or grease. They may cause diarrhea or vomiting. Keep the oil out of the reach of children.

CAUTION









Sewing

-  This sewing machine should only be used by operators who have received the necessary training in safe use beforehand.
-  The sewing machine should not be used for any applications other than sewing.
-  Be sure to wear protective goggles when using the machine.
If goggles are not worn, there is the danger that if a needle breaks, parts of the broken needle may enter your eyes and injury may result.
-  Turn off the power switch at the following times. If the foot switch is depressed by mistake, the sewing machine might start operating and injury could result.
 - When threading the needle
 - When replacing the bobbin and needle
 - When not using the machine and when leaving the machine unattended
-  If using a work table which has casters, the casters should be secured in such a way so that they cannot move.
-  Attach all safety devices before using the sewing machine. If the machine is used without these devices attached, injury may result.
-  Do not touch any of the moving parts or press any objects against the machine while sewing, as this may result in personal injury or damage to the machine.
-  If an error occurs in machine operation, or if abnormal noises or smells are noticed, immediately turn off the power switch. Then contact your nearest Brother dealer or a qualified technician.
-  If the machine develops a problem, contact your nearest Brother dealer or a qualified technician.

Cleaning

-  Turn off the power switch before carrying out cleaning. If the foot switch is depressed by mistake, the sewing machine might start operating and injury could result.
-  Be sure to wear protective goggles and gloves when handling the lubricating oil and grease, so that they do not get into your eyes or onto your skin. If the oil and grease get into your eyes or onto your skin, inflammation can result.
Furthermore, do not drink or eat the lubricating oil or grease. They may cause diarrhea or vomiting.
Keep the oil out of the reach of children.

Maintenance and inspection

-  Maintenance and inspection of the sewing machine should only be carried out by a qualified technician.
-  Ask your Brother dealer or a qualified electrician to carry out any maintenance and inspection of the electrical system.
-  Turn off the power switch and disconnect the power cord before carrying out the following operations. If the foot switch is depressed by mistake, the sewing machine might start operating and injury could result.
 - Inspection, adjustment and maintenance
 - Replacing consumable parts such as the rotary hook
-  Disconnect the air hoses from the air supply and wait for the needle on the pressure gauge to drop to "0" before carrying out inspection, adjustment and repair of any parts which use the pneumatic equipment.
-  Hold the machine head with both hands when tilting it back or returning it to its original position.
In addition, do not subject the machine head to extra force while it is tilted back. If this is not observed, the machine head may become unbalanced and fall down, and serious injury or damage to the sewing machine may result.
-  If the power switch and air need to be left on when carrying out some adjustment, be extremely careful to observe all safety precautions.
-  Use only the proper replacement parts as specified.
-  If any safety devices have been removed, be absolutely sure to re-install them to their original positions and check that they operate correctly before using the machine.
-  Any problems in machine operation which result from unauthorized modifications to the machine will not be covered by the warranty.

[3] Warning labels

The following warning labels appear on the sewing machine.

Please follow the instructions on the labels at all times when using the machine. If the labels have been removed or are difficult to read, please contact your nearest dealer.

1

	⚠ 危険		⚠ 危険		
	高電圧部分にふれて、大けがをすることがある。電源を切り、5分たってからカバーをはずすこと。		触摸高压电部分，会导致受伤。在切断电源5分钟后，再开启盖罩。		
⚠ DANGER		⚠ GEFAHR		⚠ DANGER	
Hazardous voltage will cause injury. Turn off main switch and wait 5 minutes before opening this cover.		Hochspannung verletzungsgefahr! Bitte schalten sie den Hauptschalter aus und warten sie 5 minuten, bevor sie diese abdeckung öffnen.		Un voltage non adapte provoque ces blessures. Eteindre l'interrupteur et attendre 5 minutes avant d'ouvrir le capot.	
		⚠ PELIGRO		Un voltaje inadecuado puede provocar las heridas. Apagar el interruptor principal y esperar 5 minutos antes de abrir esta cubierta.	

2

	⚠ 注意	
	触摸运动部分，易造成受伤。所以在装上安全保护装置后，再进行缝纫操作。在切断电源后，进行穿线，更换梭芯，机针和做清扫，调整工作。	
⚠ CAUTION		
Moving parts may cause injury. Operate with safety devices. Turn off main switch before threading, changing bobbin and needle, cleaning etc.		

3  Be careful to avoid getting hands caught in sliding parts.

4  Be sure to connect the ground. If the ground connection is not secure, you run a high risk of receiving a serious electric shock, and problems with correct operation may also occur.

5  Direction of operation

Safety devices:

Devices such as eye guard, finger guard, thread take-up cover, motor cover, X motor cover, tension release solenoid cover, inside cover, outside cover, middle cover, fixed cover and rear cover

Contents

CHAPTER I SPECIFICATIONS.....	1
1.1 PARAMETERS OF PRODUCT.....	1
1.2 SPECIFICATIONS OF TEMPLATE.....	2
CHAPTER II NAMES OF MAJOR PARTS.....	3
CHAPTER III INSTALLATION.....	4
3.1 ADJUSTING CASTERS.....	4
3.2 ASSEMBLY OF BEDPLATES.....	4
3.3 LUBRICATION.....	5
CHAPTER IV PREPARATION BEFORE SEWING.....	7
4.1.INSTALLING THE NEEDLE.....	7
4.2.INSTALLING AND INSERTING BOBBIN CASE.....	7
4.3.THREADING THE UPPER THREAD.....	8
4.4.THREAD TENSION.....	9
4.5.ADJUSTING THE THREAD TAKE-UP SPRING.....	9
4.6.ADJUSTING ARM THREAD GUIDE R.....	10
4.7.ADJUSTMENT OF LINE SWEEPING DEVICE.....	10
CHAPTER V ADJUSTING THE MACHINE HEAD.....	11
5.1.ADJUSTING THE PRESSER FOOT MECHANISM.....	11
5.2.ADJUSTING THE NEEDLE BAR HEIGHT.....	13
5.3.ADJUSTING POSITIONS OF THE NEEDLE AND THE ROTARY HOOK.....	13
5.4.ADJUSTING POSITION OF THE FIXING ROD FOR INTERNAL SHUTTLE RACE	14
5.5.ADJUSTING SCISSOR ENGAGEMENT.....	15
CHAPTER VI INTRODUCTION TO CONTROL SYSTEM.....	17
6.1 OVERVIEW.....	17
6.2 FUNCTIONAL DESCRIPTION.....	17
6.3 NOTES.....	18
6.3.1 Safety Instruction.....	18
6.3.2 Work Environment.....	19
6.3.3 Power Supply Requirement.....	19
6.3.4 Grounding Requirement.....	19
CHAPTER VII DESCRIPTION OF MAIN INTERFACE.....	21
7.1 SYSTEM POWER-UP.....	21
7.2 MAIN INTERFACE OF PROCESSING.....	21
7.2.1 Display Instruction for Main Interface of Processing.....	21
7.2.2 Test Interface Display Description.....	24

7.2.3 Display Instruction for Manual Frame Movement Interface.....	26
7.2.4 Display Instruction for Reference Setup Interface.....	28
7.2.5 Process Statistics Interface Display Instruction.....	30
7.3 MAIN MENU INTERFACE.....	31
CHAPTER VIII FILE MANAGEMENT.....	33
8.1 MEMORY FILE MANAGEMENT.....	33
8.2 MANAGEMENT OF FILES IN USB FLASH DISK.....	34
CHAPTER IX FILE EDITING.....	36
9.1 MAIN INTERFACE OF FILE EDITING.....	36
9.2 CAPTURING GRAPHS.....	36
9.3 IDLE CAPTURE.....	39
9.4 SINGLE NEEDLE ACQUISITION.....	40
9.5 STRAIGHT LINE CAPTURE.....	40
9.6 RECTANGLE CAPTURE.....	41
9.7 POLYLINE SEGMENT CAPTURE.....	41
9.8 ARC CAPTURE.....	42
9.9 CIRCLE CAPTURE.....	43
9.10 CURVE CAPTURE.....	44
9.11 MULTIPLE CURVES.....	44
9.12 REINFORCEMENT PRESET.....	46
9.13 FUNCTION CODE.....	48
9.14 GRAPH EDITING.....	51
CHAPTER X PARAMETER FILE.....	61
CHAPTER XI USER PARAMETERS.....	63
11.1 USER PARAMETERS INTERFACE.....	63
11.2 INTRODUCTION TO USER SETTING PARAMETERS.....	65
CHAPTER XII MACHINE PARAM.....	77
12.1 MACHINE PARAM INTERFACE.....	77
12.2 INTRODUCTION TO SETTING UP MECHANICAL PARAMETERS.....	79
CHAPTER XIII ASSIST SETTING.....	88
13.1 ASSIST SETTING INTERFACE.....	88
13.2 INPUT TEST.....	89
13.3 OUTPUT TEST.....	89
13.4 NETWORK SETTINGS.....	91
13.5 DATE SETTINGS.....	92
13.6 LOCK SETTINGS.....	93
13.7 SYSTEM LANGUAGE.....	94
13.8 SYSTEM UPGRADE.....	95
13.9 DRIVER PREVIEW.....	96

13.10 TEST TRANSFER.....	97
CHAPTER XIV MACHINE STATE.....	99
CHAPTER XV Maintenance.....	100
15.1 CLEANING.....	100
15.2 DRAINING WASTE OIL.....	100
15.3 APPLICATION OF LUBRICATING GREASE ONTO METAL PARTS UNDER NEEDLE BAR	101
APPENDIX I: INFORMATION PROMPT AND SOLUTIONS.....	102
APPENDIX II: QUICK START GUIDE.....	107

Chapter I Specifications

1.1. Parameters of product

Model	C913-M/YK
Scope of sewing	Max.1300X850mm
Hook	Double hook
Stitch	0.1-12.7mm
Line	Sing-needle flat seam
Maximum sewing speed	3000rpm
Wiper device	Standard equipment
Presser foot	Auxiliary medium pressure foot + middle pressure foot.
Height of presser foot	22.5mm
Intermediate pressure foot	7mm
Needle	DP*5 9#
Needle height	23mm
Threaad breakage detector	Standard facility
Template recognition	Standard facility
Work assist	Optional
Storage pattern	999 kinds of sewing patterns
File format	DXF
Product specification	2115mmx2000mmx1350mm
Weight	550kg
Motor	AC servomotor 550W
Power	Single phase200-240V
Air pressure	0.5Mpa 、 1.8L/min

1.2.Specifications of template

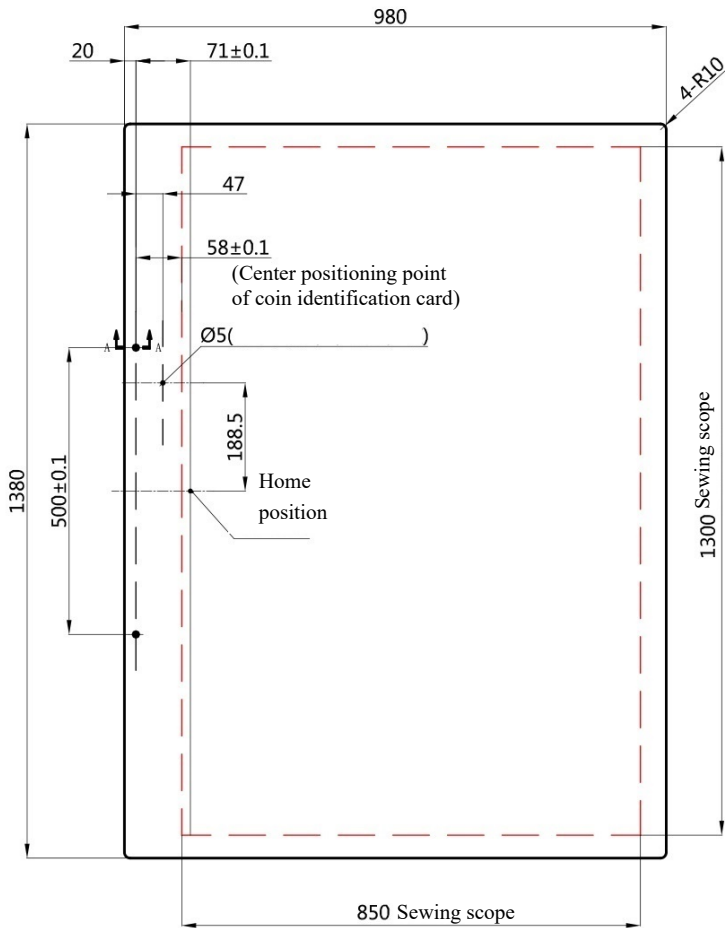

When using the clamp template, after aligning the middle notch with the positioning shaft on the module and push it to the finish. The notches on both sides will contact the corresponding touch sensors to control the pressing of the clamp.

Template for clamp module

Chapter II Names of major parts

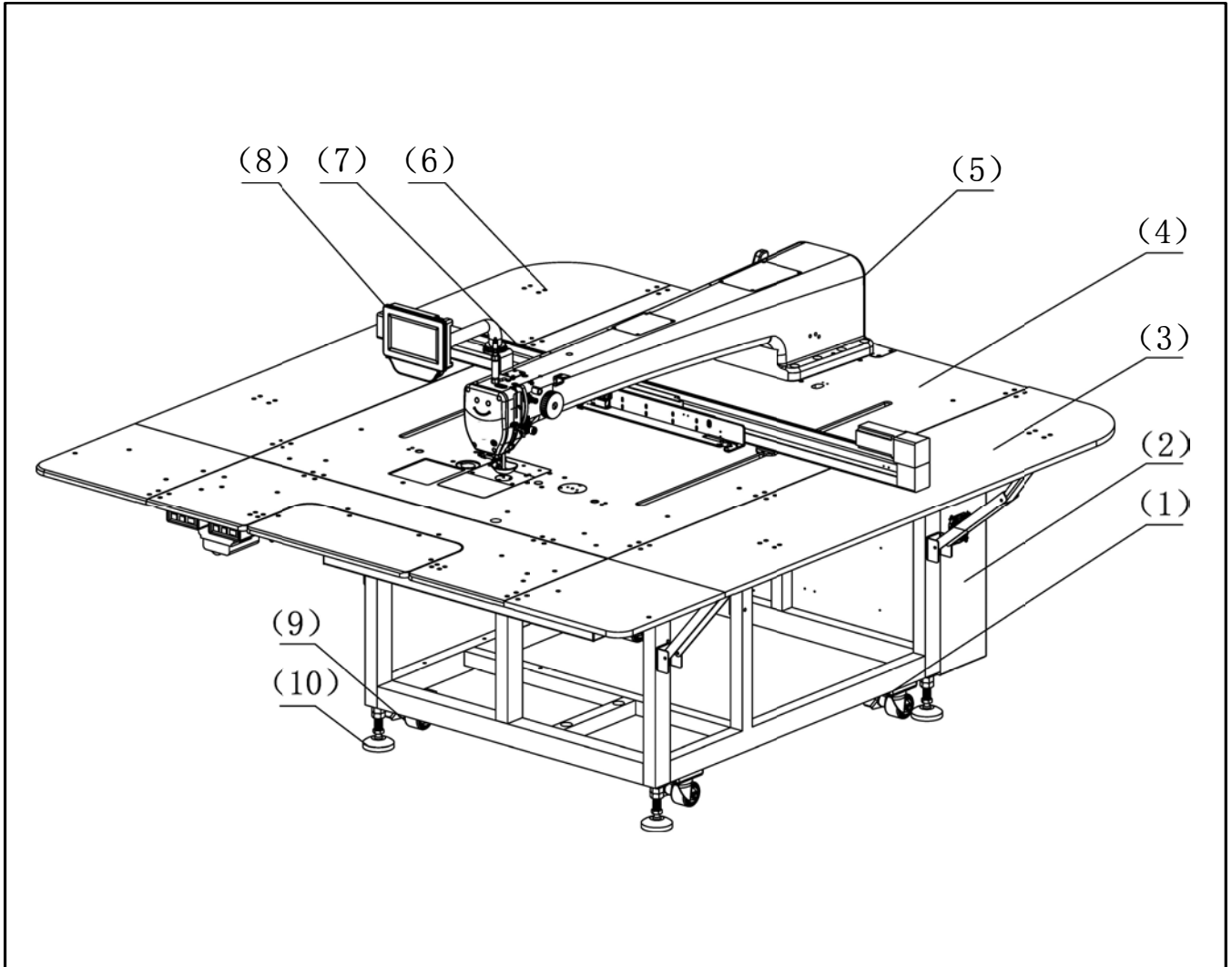

- (1) Frame
- (2) Electric control box
- (3) Right platen
- (4) Main table
- (5) Nose
- (6) Left platen
- (7) X module
- (8) Operation panel
- (9) Casters
- (10) Foot

Chapter III Installation

3.1 Adjusting casters

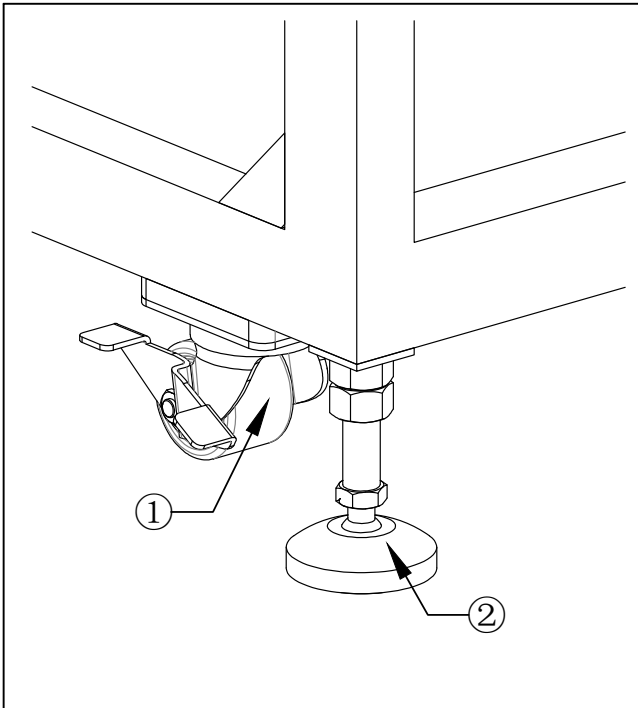

- 1.The initial state is ①The casters are on the ground, and the equipment can be pushed at will.
- 2.After the equipment is in place, turn the foot ② clockwise to make the foot contact with the ground.
- 3.After the four feet are in full contact with the ground, you can use a wrench to turn the adjusting nut clockwise to fix the position of the equipment, and control the four adjusting nuts to keep the equipment in balance.

Note:Before operating the equipment, firstly lay down supporting blocks②on the casters and try to make the casters suspend in the air to ensure speedy and stable running of the equipment .

3.2.Assembly of bedplates

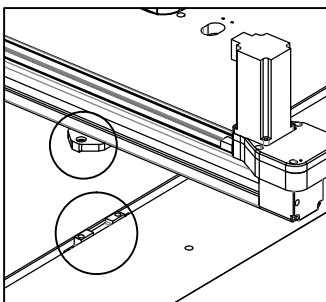
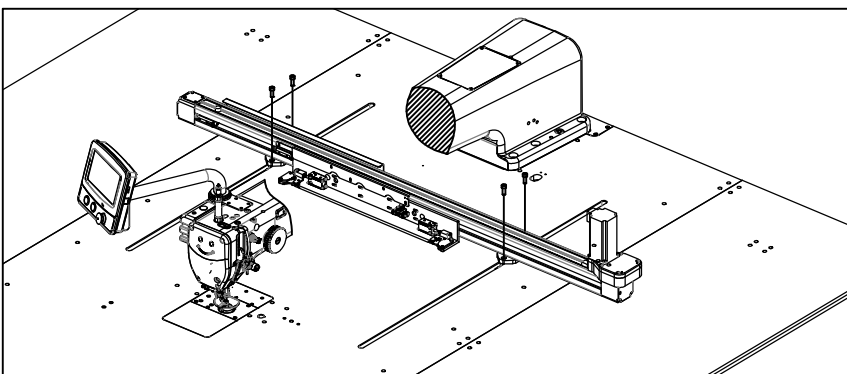

Adjust the position of the slider and install the X-axis module on the beam (the joint is provided with a slot, and the module can be clamped on the beam slider, and then tighten the screw to ensure accuracy).

3.3. Lubrication



warning

1. To avoid any accident resulting from the sudden starting of the sewing machine, don't connect power plug before completing oiling.
2. To avoid inflammation or maculae, please immediately wash your eyes or any part of your body upon their exposure to oil.
3. Oil drinking may result in diarrhea or vomiting. Keep the oil out of the reach of children.

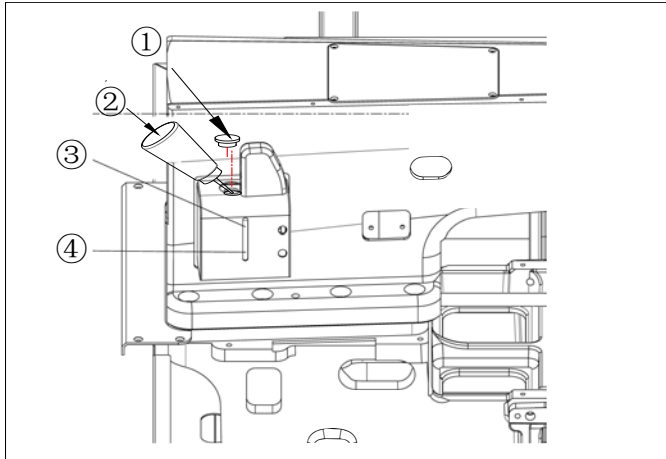

Note: Before running the sewing machine, fill oil into the oil tank.

1、 Remove oil filler cap ①, and add engine oil by using the oiler ②.

2、 There are two indicating lines on the oil tank. Stop filling when the oil level reaches the indicating line ③.

In daily use, when the oil level is lower than the indicating line ④, oil needs to be filled immediately.

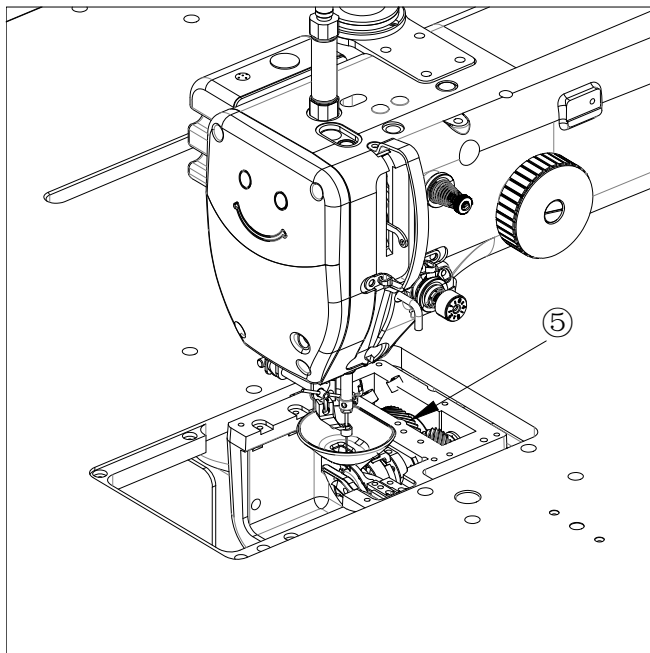

Exchange the oil in the gearbox oil groove once every three months.



1. Don't use new template sewing machines or sewing machines left unused for a long time without a prior run-in implemented below 2000RPM.
2. Be sure to add clean engine oil by using oiler.
3. Don't run the sewing machine whose oil filler cap ① is removed. Remove the oil filler cap ① only for oiling. Besides, don't lose the oil filler cap ①.

Addition of lead screw and guide rail lubricating oil

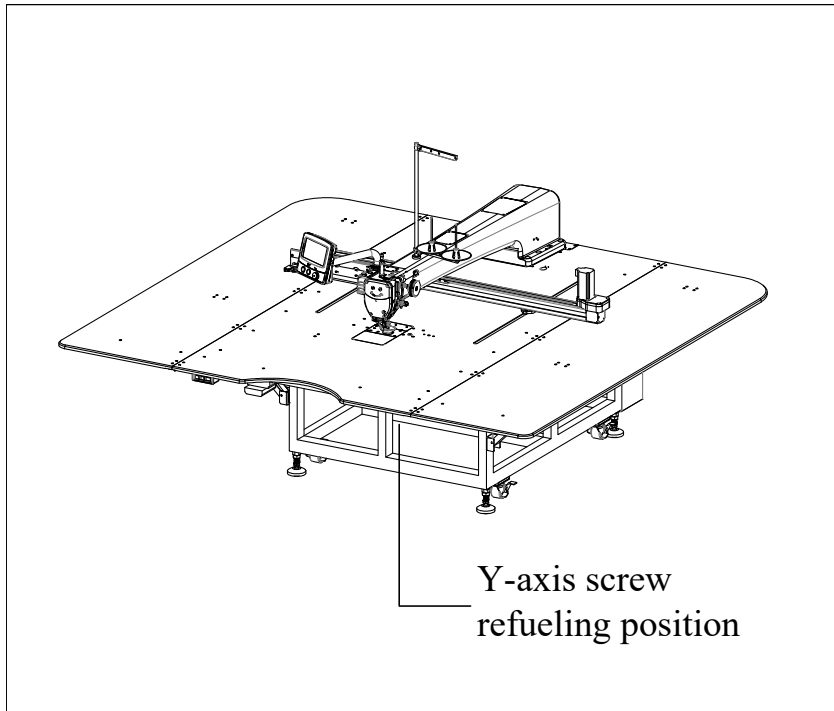

When the Y-axis screw moves to position ⑥, oil it from the bottom.

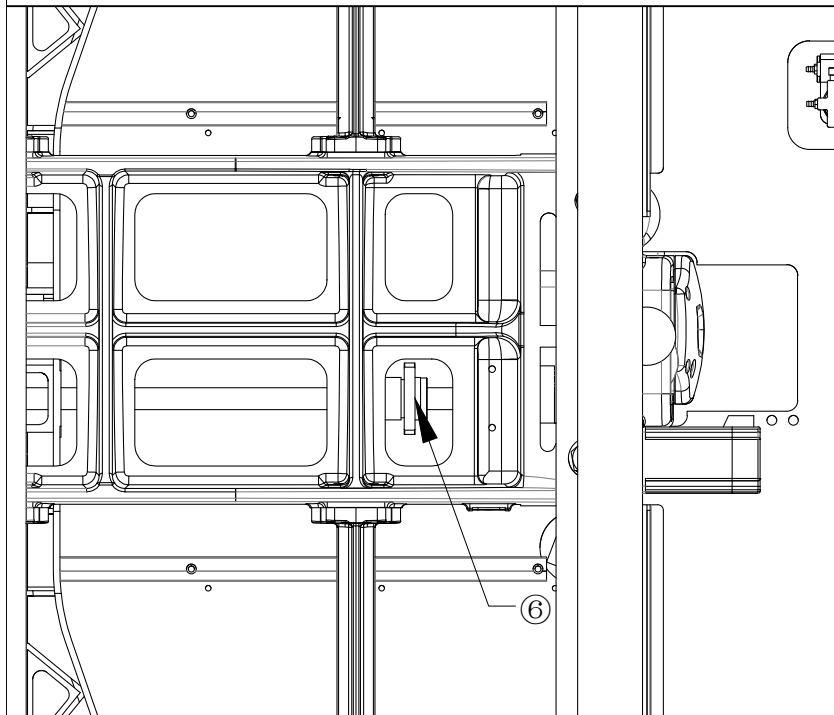

Chapter IV Preparation before sewing

4.1. Installing the needle



Warning:

In order to prevent the personal injuries caused by accidental start-up, please turn off the power and make sure the motor stops before operating.

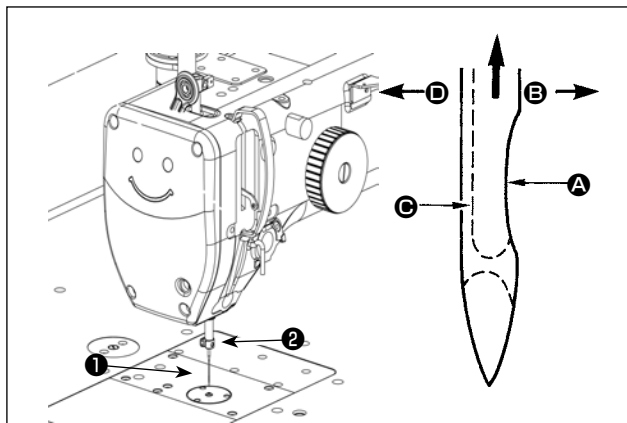

Please use only needles designed for sewing machines with different specifications. Meanwhile, please select proper sewing machine needles according to the thickness of sewing threads and the types of cloth materials.

- 1) Rotate the flywheel to lift the needle bar to the highest point;
- 2) Unscrew needle fixing screw ②, hold the needle ① in hand, and horizontally shift its recess A to direction B;
- 3) Have the needle inserted deep into needle bar hole until reaching the designated position;
- 4) Tighten needle fixing screw ②;
- 5) Ensure that the long hole C of the needle is in the left horizontal direction D.

4.2. Installing and inserting bobbin case



Warning:

In order to prevent the personal injuries caused by accidental start-up, please turn off the power and make sure the motor stops before operating.

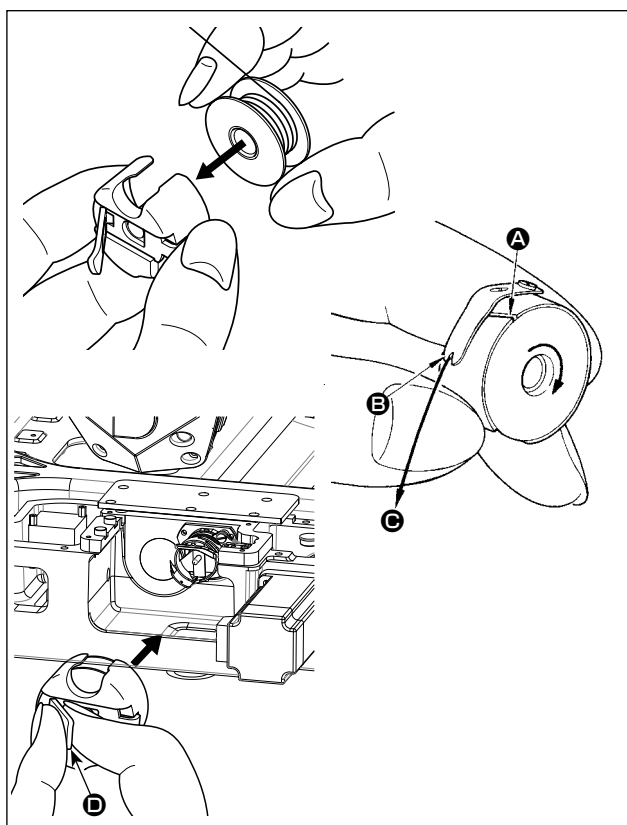

- 1) Rotate the flywheel to lift the needle from the needle plate;
- 2) Hold the bobbin and roll the thread roll rightward into the bobbin case;
- 3) Have the thread passed through the threading hole A of bobbin case, pull the thread toward direction C, and then pull it out from the threading hole B under the thread tension spring;
- 4) Pull the lower line to confirm whether the bobbin rotates in the direction indicated by the arrow;
- 5) Hold the gripper D of bobbin case and put the bobbin case into the rotary hook.

4.3. Threading the upper thread



Warning:

In order to prevent the personal injuries caused by accidental start-up, please turn off the power and make sure the motor stops before operating.

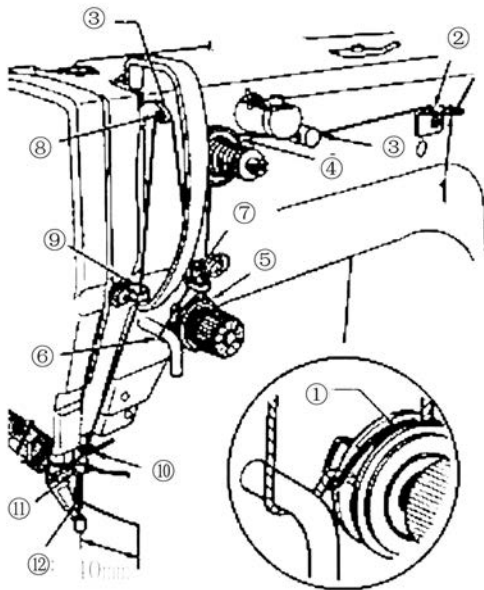

1) Perform threading work only in the threading mode or when the power is turned off;

2) Correctly implement upper threading according to the numbering sequence shown in the left figure;

3) Turn the machine pulley to its highest position before threading the upper thread;

4.4.Thread tension

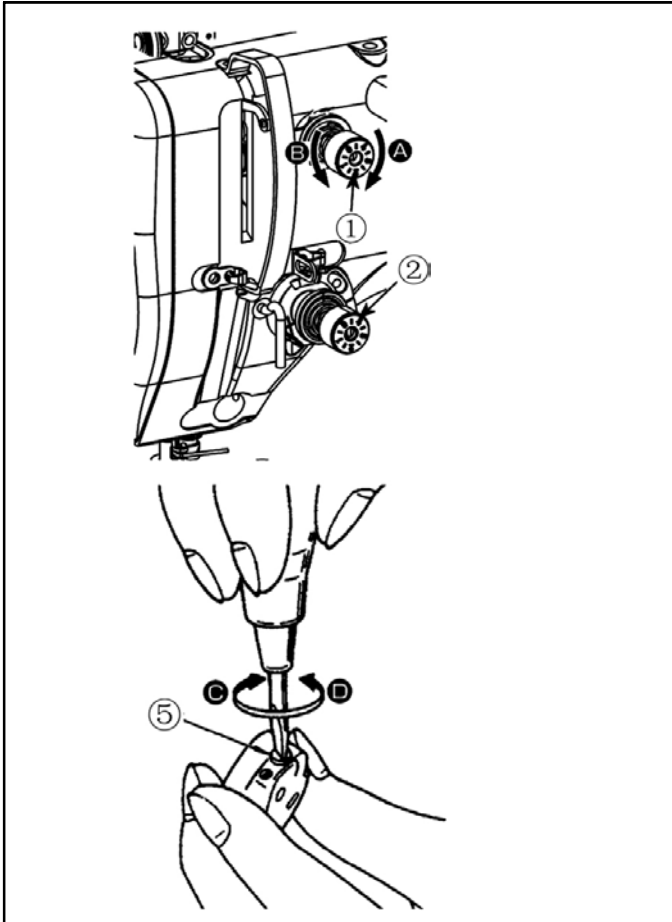

When the first-thread tensioner nut ① is rotated right toward direction ②, the thread remaining on the needle after being trimmed becomes shorter, and when it is rotated left toward direction ③, the remaining thread becomes longer.

- 1) Turn the thread tension screw to the right C direction ⑤, the bobbin thread tension becomes stronger, and when it is turned in the left direction D, the bobbin thread tension becomes weaker.

4.5.Adjusting the thread take-up spring

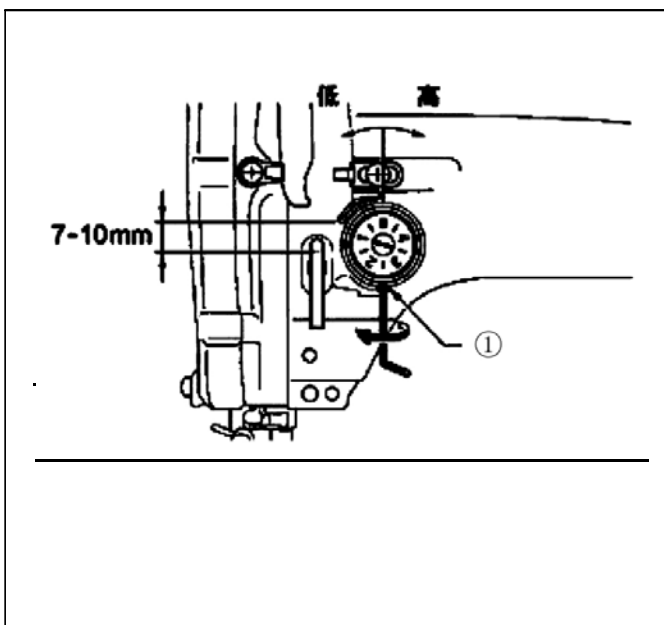

- 1) Loosen the hexagon socket set screw ①,
- 2) Rotate the entire thread loosening device ② for adjustment;
- 3) Tighten the set screw ①.

4.6. Adjusting arm thread guide R

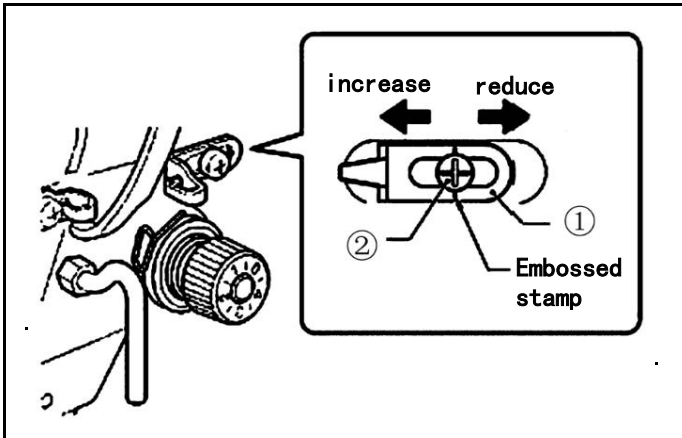

1) The standard position of arm thread guide R (1) is when the screw (2) is aligned with the index mark.

2) Loosen the screw (2) and move arm thread guide R (1) to adjust.

- When sewing heavy material, move arm thread guide R (1) to the left. (The thread take-up amount will become greater.)
- When sewing heavy material, move arm thread guide R (1) to the left. (The thread take-up amount will become greater.)

4.7. Adjustment of line sweeping device

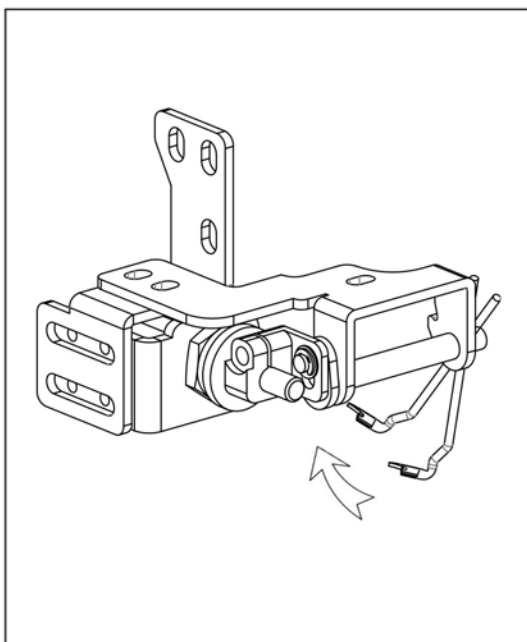
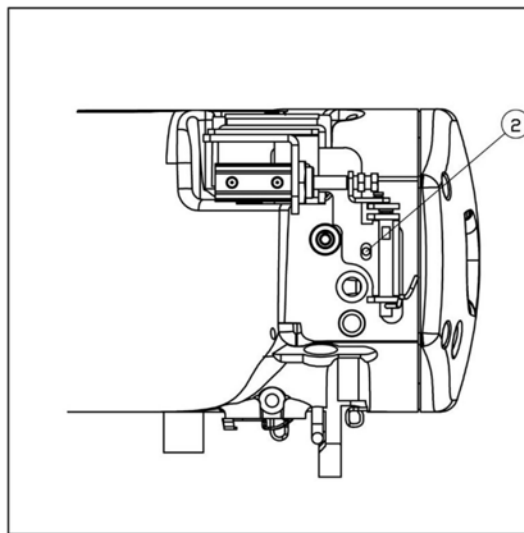
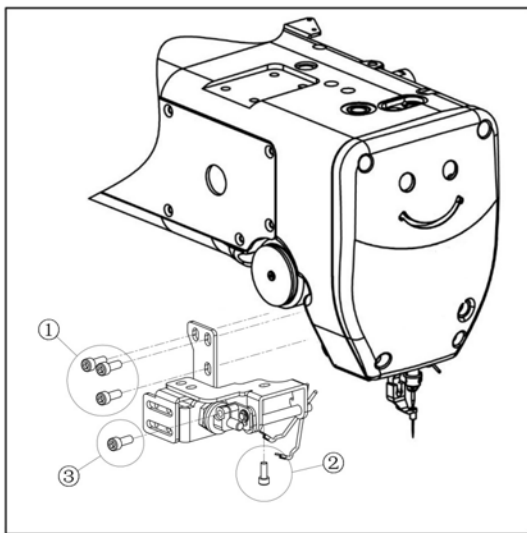

- 1) the above ①, ② position of the screw into the pre-tightening state, reset the sweep line hook position, finally lock the screw ①, ②.
- 2) tighten the screws at ③ to adjust the tightness of the mounting clip. Adjust the initial height of the sweep hook according to the locking position of the mounting clip.
- 3) track of line sweeping device is shown in the left figure.

Chapter V Adjusting the machine head

5.1. Adjusting the presser foot mechanism



Warning

In order to prevent the personal injuries caused by accidental start-up, please turn off the power and make sure the motor stops before operating.

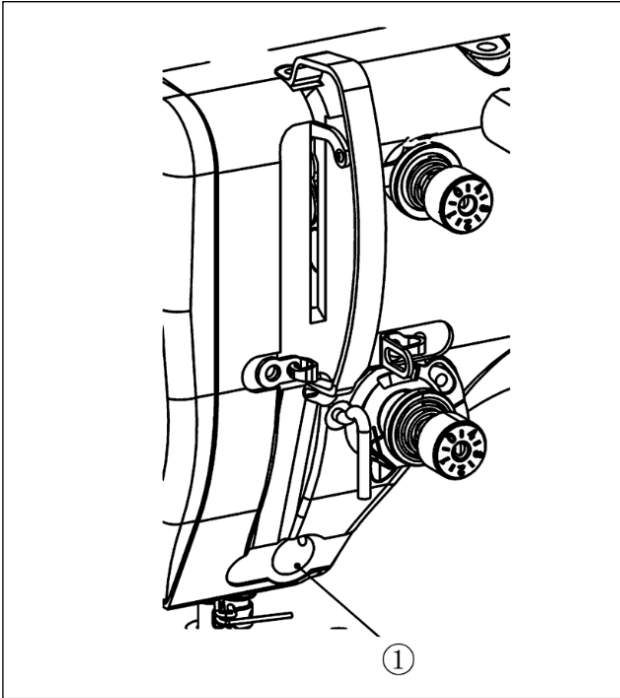

Just like thread wiper in the past, the upper thread can be wound onto the back of the fabric.

[Features]

- Contraction joints can be used together with threading presser device ① to reduce the failure at the back of the fabric, which is generally called the 「bird nest」 ;
- Improved operating efficiency around the needle;
- Easy to use a variety of needle attachments.



When using memory switch 「reversed lift of needle after U056 thread trimming」, considering that the thread needle adopted is quite long, set the threading device as OFF.

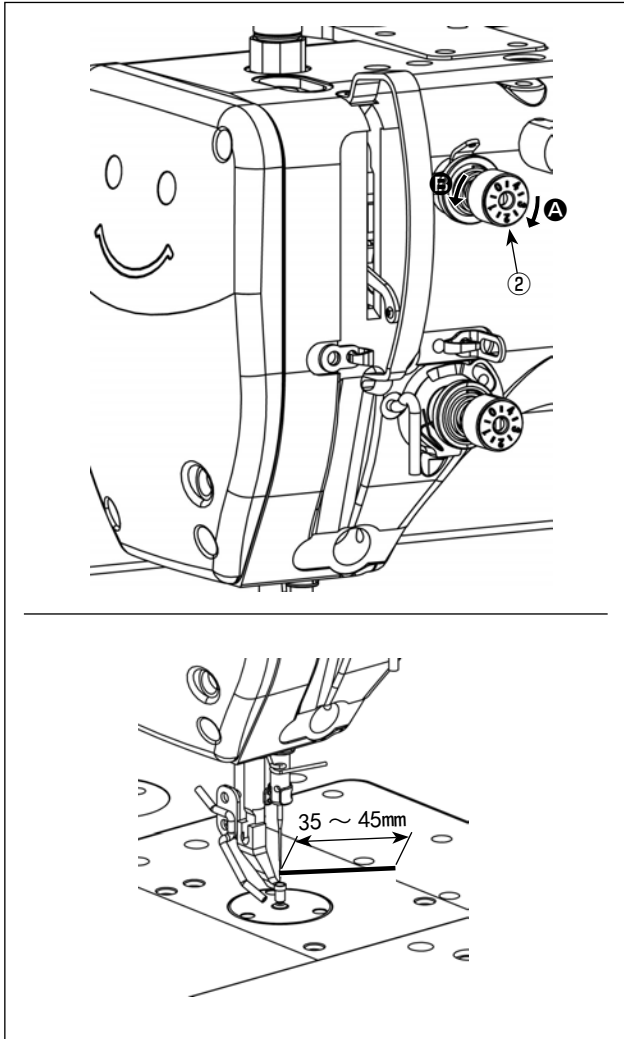

[Adjusting residual length of needle thread]

Please rotate the first-thread tensioner nut ② to adjust the residual length of needle thread as 35-45mm (S specification and H specification are both the same);

- 1) When the first-thread tensioner nut ② is rotated right toward direction A , the thread remaining on the needle after being trimmed becomes shorter, and when it is rotated left toward direction B , the remaining thread becomes longer.

After the residual length of needle thread is shortened, the generally called 「bird nest」 can be relieved to some degree, but the thread is likely to drop from the needle after the sewing starts. At this time, reducing the initial sewing speed can help resolve dropping of needle thread.



[emory switch]

- U286 tension sewing speed; Reduce (ex-factory value: 300sti/min)
- U293 tension sewing speed releasing angle: Postpone (ex-factory value: 340°)



As to the setup value of memory switch, it is recommended to have U286 tension sewing speed set as 250sti/min and U293 tension sewing speed releasing angle set as 720° .

5.2.Adjusting the needle bar height

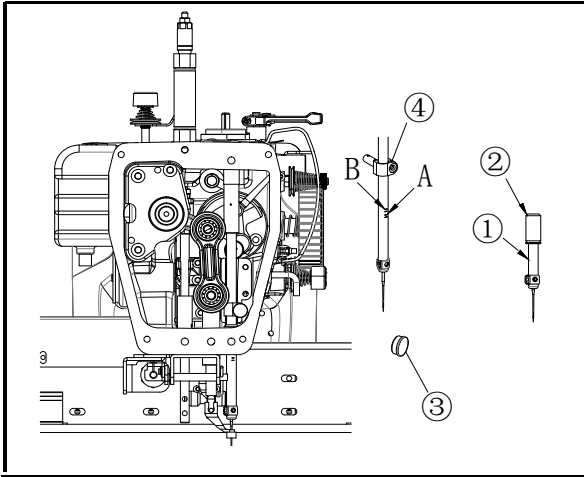

- 1) When the power is OFF, rotate needle bar ① to the lowest point;
- 2) Needle bar timing mark A should be aligned with the lower edge of the needle bar bush ②; (when using DPX17 needle)
- 3) If the alignment just mentioned fails to be achieved, remove the rubber bolt ③, loosen needle bar fixing screw ④ to adjust the height of needle bar;
- 4) When using DPX5 needle, adopt timing mark B for adjustment and alignment.

5.3.Adjusting positions of the needle and the rotary hook

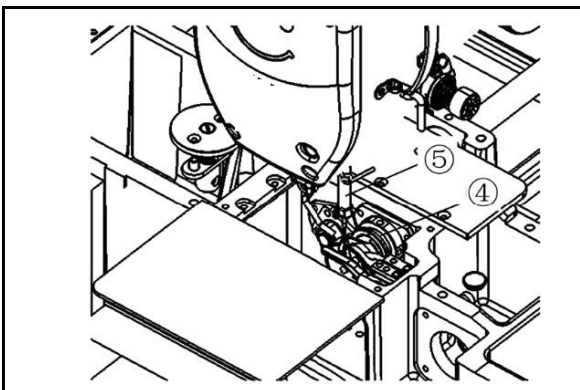
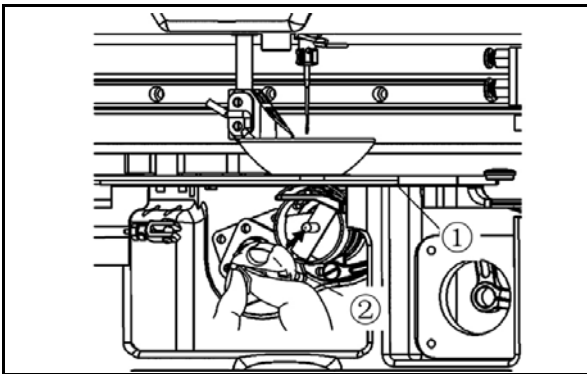

- 1) Turn OFF power switch first;
- 2) Take down the bobbin case ②;
- 3) Remove the sliding plate ①;
- 4) Loosen the 3 fixing screws ④ of shuttle race;
- 5) Rotate the manually handled wheel to lower the needle bar ⑤ to the lowest point before lifting it again, and then continue the rotation till the second check mark of the needle bar is aligned with the lower edge of the needle bar bush ⑥;

Note: When using DPX5 needle, adopt timing mark D for adjustment and alignment.

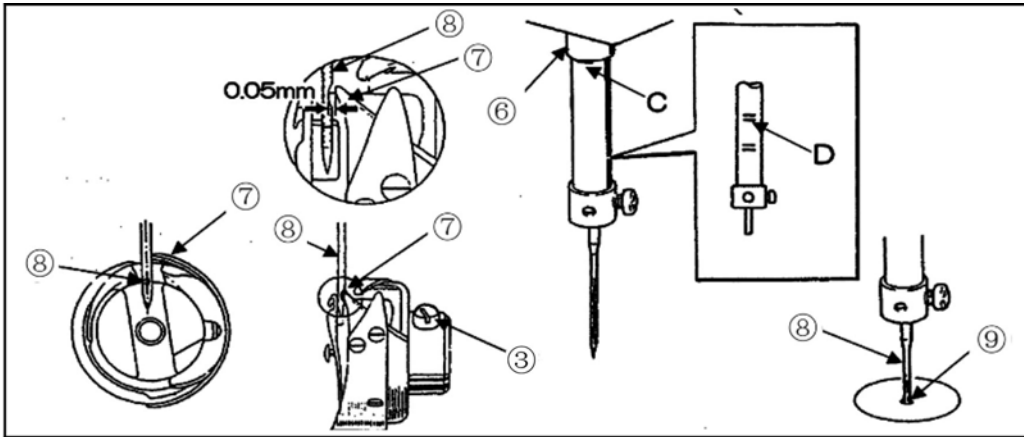

- 6) Manually rotate shuttle race to make the tip ⑦ of the shuttle race be aligned with the center of the needle ⑧;
- 7) The clearance between the above-mentioned tip ⑦ and needle ⑧ should be about 0.05mm (roughly equaling to the diameter of a hair), as shown in the figure. Completing the adjustment;
- 8) Tighten the 3 fixing screws ③ of shuttle race;
- 9) After the adjustment, install the sliding plate ① and the bobbin case ②;

Note: Note that when installing the sliding plate ①, you need to have the dropped needle ⑧ inserted at the center of the needle plate hole ⑨ to determine the position of the sliding plate ①.

5-4. Adjusting position of the fixing rod for internal shuttle race

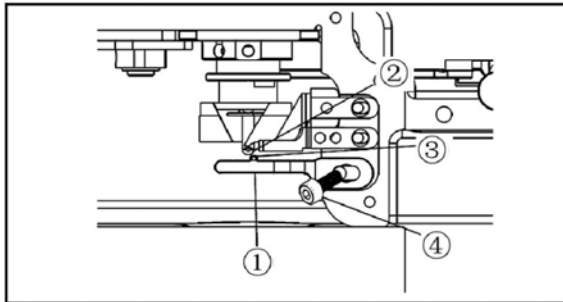

- 1) Remove the sliding plate.
- 2) The standard position of the fixing pole for internal shuttle race is shown in the figure, and the right side ② of the needle should be aligned with the projecting side ③ of the fixing pole, which can be adjusted through loosening the fixing screw ④ to move the fixing pole ①.
- 3) Properly recover and install the sliding plate after completing the adjustment.

Note: Note that when installing the sliding plate, you need to have the dropped needle inserted at the center of the needle plate hole to determine the position of the sliding plate.

5.5.Adjusting scissor engagement

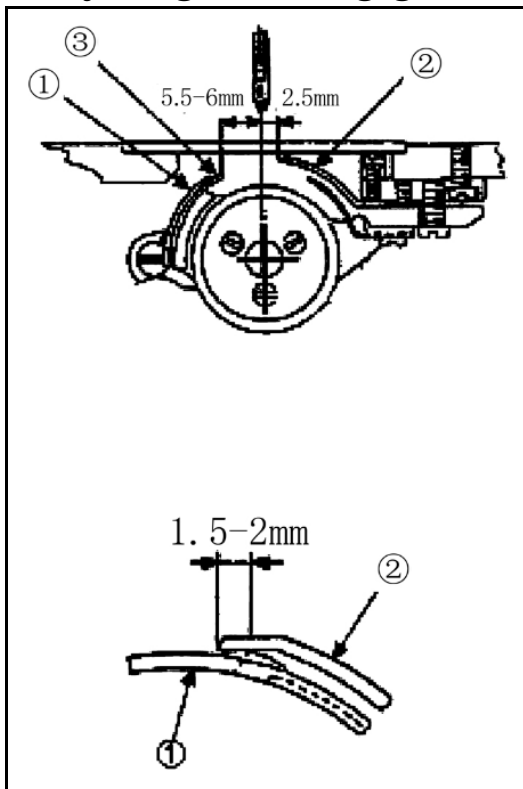

1) Standard positions of moving knife and fixed knife:relevant positions of moving knife ①, fixed knife ② and protective plate ③ should comply with corresponding specifications shown in the figure;

2) Enter the main interface, select menu → detection mode → clamp/ trimming in sequence, and then press the Start key to reset. Press SW key to adjust the state of the knife. When the indication of "highest point" appears, take out rubber plug ⑥, use inner hexagonal wrench ⑤ to adjust the fixing screw and adjust the position of the knife. After that, press SW key again to confirm the position at the "middle point" until the adjustment is completed. After completing the adjustment, press the Start switch to reset for fear of needle collision.

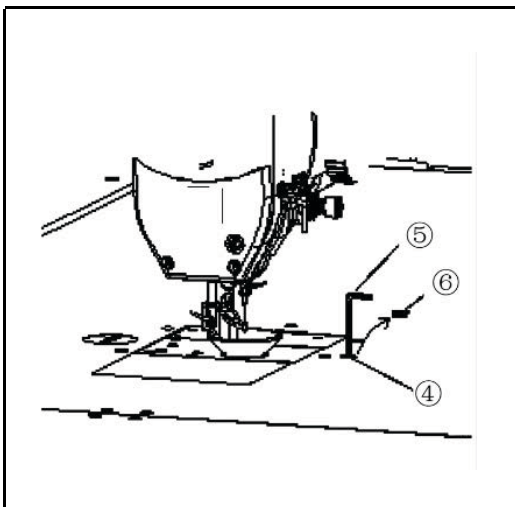

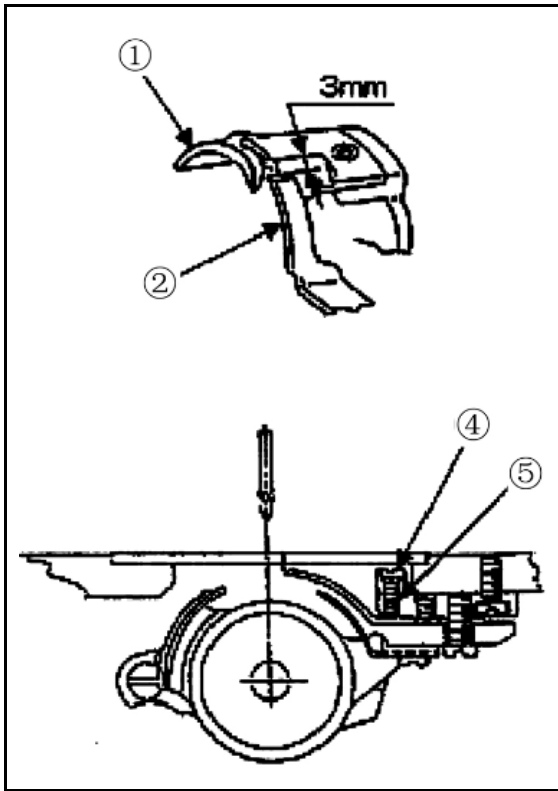

3) Adjustment on scissor engagement pressure:

at the position 3mm ahead of the ridge line of ①.

(a) The adjustment on the engagement pressure of the moving knife ① or the fixed knife ② equals to the adjustment on the height of the fixed knife ②. As shown in the figure, when the moving knife ① moves forward to touch the fixed knife ②.

(b) Make the engagement force slightly stronger when any coarse thread adopted fails to be broken.

(c) The adjustment method is as follows: remove the sliding plate to loosen the fixing screw cap ④, and then rotate the adjustment screw. When rotating tight the adjustment screw ⑤ rightward, the engagement pressure becomes stronger, and when rotating it loose leftward, the biting pressure becomes weaker. After completing the adjustment, tighten the fixing screw cap ④.

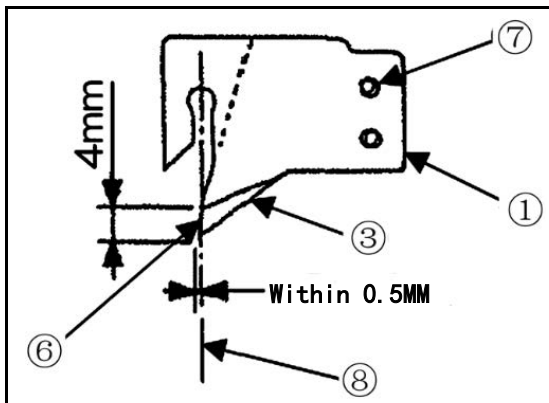

4) Adjusting the protective plate

As shown in the figure, firstly place the protective plate ③ below the moving knife ①, with the tip ⑥ of the protective plate ③ being placed 0.5mm away from the left of needle center while 4mm beyond the tip of the moving knife ①, and then have the moving knife ① and the protective plate ③ fixed together by using the fixing screw ⑦.

Chapter IV Introduction to Control System

6.1 Overview

Thank you very much for using the automatic template sewing machine control system of our company!

This system can match with the various types of template machine, satisfying different sewing requirements with satisfactory sewing effect for all sorts of cloth!

Before using, please read the Instruction carefully to ensure the correct use of this system. Please keep the instruction appropriately in order to check at any time.

In case of discrepancies between actual machine and this Instruction due to different machine configurations and software update, the operating functions shall prevail.

6.2 Functional Description

(1) One machine with multi-purpose, simple operation

- Full automatic template sewing machine can replace many kinds of special machinery such as traditional flat sewing machine, long arm sewing machine, bartack sewing machine, embroidery machine, etc. in certain circumstances to achieve multi-usage
- After placing the template well, the operating personnel only needs to press the start key, automatic processing can be completed, the operation is quite simple
- With standardized operation; the machine can work out amazing effects for a variety of stitches and a variety of fabric!

(2) The man-machine interface is friendly and easy to use

- 7 inches color LCD touch screen, with clear display, easy to touch
- Support display in Chinese, Vietnamese, Korean, Japanese and English
- Up to 256M (or 128M) file storage space, to store and process many files
- Convenient file Collection (template making), modification, management functions

(3) Precise motion control technology with efficient sewing

- Using international advanced DSP chip, fast system run speed, high hardware integration, stable performance

- Support step-by-step, closed loop step-by-step, brushless DC, servo drive, using smooth curve for speed governing, smooth operation
- Compact mechanical structure, good rigidity, high sewing position precision, low noise

(4) The upper computer graphics editing software is easy to use

- Such files in dxf, dst, dsb, ai, plt, edi, tzf format that are generated by software such as Autocad, CoreDraw are easily converted into processing files
- The software has comprehensive graphics editing functions, supports layer editing and adding various kinds of special sewing stitch lines
- With common control instruction set, customizable control instruction (functional code), high dexterity of action
- For each layer, each graphic, each stitch point, a variety of mechanical control commands can be inserted into, to meet the diversified and precise automatic sewing requirement

(5) Rich user parameter settings, comprehensive auxiliary functions

- Detail settings can be carried out for various mechanical actions
- Point position, painting line, automatic mold slot opening function of some equipment can be extended
- Support automatic identification of template, U Disk system updates, broken threads detection, continue sewing in power down, processing statistics, forecast for lack of bobbin thread, system self-test, parameter backup and recovery, encryption lock machine...

6.3 Notes

6.3.1 Safety Instruction

In order to avoid the possible risk and prevent damage to the device, please observe the following safety matters:



Note:

- Please don't carry out maintenance and debugging to electric system by non-specialists, this will reduce the safety performance of equipment, enlarge the fault, and even cause harm to the personnel and property losses.

- Some parts inside the case have high pressure; after the system is powered on, please do not open the case cover, in order to avoid accidental injury.
- Please do not pile up sundry around the control box, and in the process of using; remove dust on the surface of control box and the filter regularly, so as to keep good ventilation for the system, which is good for heat dissipation.
- Without authorization of the company, please do not make any change to the product arbitrarily, and the company shall not hold any responsibility for the consequences!



- **If it really needs to open the case cover, it must be carried out 5 minutes after cutting off power and guided by professionals to contact components inside the electrical cabinet!**



- **When the machine is at work, it is forbidden to contact with any moving part or open the control equipment, plug or pull out motor interface, otherwise it may cause personal injury or the machine not to work!**
- **It is forbidden for electrical equipment to work in places with humidity, dust, corrosive gas, flammable and explosive gas, otherwise it may cause electric shock or fire!**

6.3.2 Work Environment

- Solid, level ground installation
- Good ventilation, healthy environment, less dust
- Temperature in work space: 5 to 40 °C
- Relative humidity in work space: 30% to 90% without condensation

6.3.3 Power Supply Requirement

- Single-phase AC220V/50 to 60 HZ
- It needs to be equipped with the voltage regulation equipment when the power grid voltage fluctuation is more than 10%
- Equipment power is between 1.0 to 2.0KW according to different machine configuration

6.3.4 Grounding Requirement

- In order to prevent electric shock or fire accident of electrical equipment due to causes such

as electric leakage, over voltage, insulation, etc., please make sure the electronic control with reliable grounding

- The grounding resistance should be less than 100 ohms, conductor length within 20 meters, conductor cross-sectional area greater than 1.0 square millimeters

Chapter VII Description of Main Interface

7.1 System Power-up

Upon system power-up, the HMI displays the boot screen, when the spindle will automatically rotate for testing and reset other parts. The reset action is related to power-up reset parameters setup.

7.2 Main Interface of Processing

7.2.1 Display Instruction for Main Interface of Processing

The main interface of processing is automatically activated after the display of boot logo. The main interface of processing is shown below:

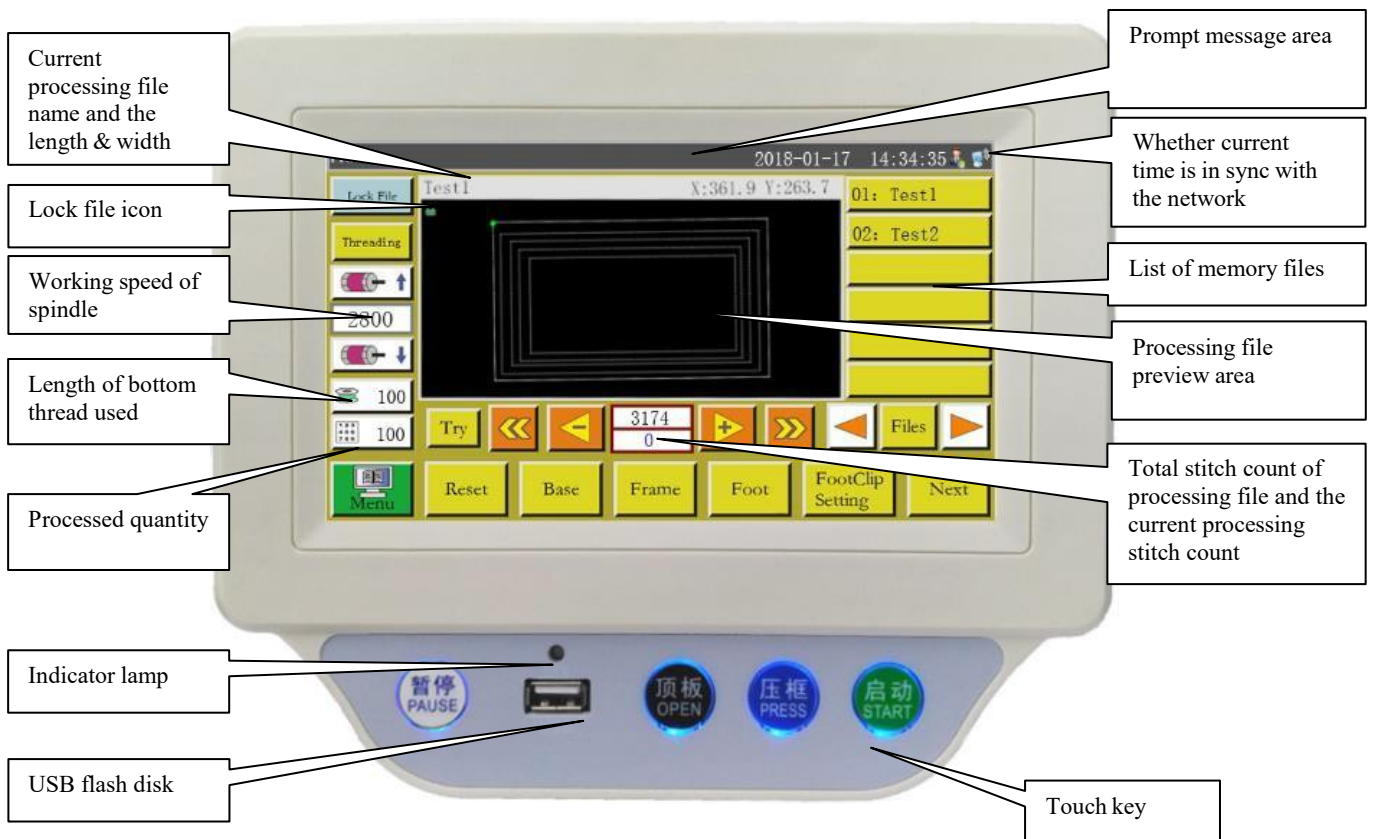



Fig. 2-1 Main interface of processing

Key functions in the main interface of processing are described as follows:

Processing file preview area: Show the currently selected file graph; click to switch between “full graph” (scale for optimal display) and “at ratio” (actual ratio to the processing range). When the processing graph is greater than 8,000 stitches, only “full graph” display mode is available.

List of memory files: Show the list of memory files; click to choose different processing files.

Lock File: "lock file" key: Lock the currently processed file to prevent misoperation. Once a file is

locked up, other processing files can't be chosen, when  icon will appear in the preview area. Click once to lock, and click again to unlock.

Note: Automatic template recognition will work only in the locked state of "lock file". The recognized template is displayed in the "prompt message area", and the corresponding numbered file will be automatically selected. If the "template recognition mode" is set to "by file name", electronic tag (identifier) will be used to match the file name; if it is set to "by serial number of file", the serial number of file will be matched using a code scanner.

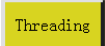
:The needle-threading function. After entering the threading state, the pressing foot is automatically lowered and the starting operation is automatically locked to prevent accidental start-up.

:"Acceleration" key.The rotating speed of spindle increases by 100 rpm. If this key is pressed and held (long-pressed), the speed will increase continuously until the set max speed is reached. Arbitrary change to rotating speed can be prohibited by setting a password.

:"Deceleration" key.The rotating speed of spindle decreases by 100 rpm. If this key is pressed and held, the rotating speed will decrease continuously until the set min. speed is reached. Arbitrary change to rotating speed can be prohibited by setting a password.

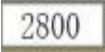
: Display the current spindle speed. Click to pop up the "File Speed" setting interface to set the independent speed of the current file . If set to 0, it means no independent processing speed.

: "Bottom thread statistics" key. Show the used length of bottom thread. Press the key to enter the processing statistics interface.

: "Processing statistics" key. Show the finished quantity. Press the key to enter the processing statistics interface.

: "Main menu" key, Press the key to get into main menu interface.

: "Try" key, It is used to simulate the processing process based on graphical trajectory. When this key is depressed, XY axes rotate while the spindle is stationary.

: "Segment fast reverse" key, Manually move back without load to the starting point of the

previous continuous curve. Return without load means the spindle remains stationary while XY axes move. This key is used to preview the designated needle location or start the processing from the designated needle location.



:"Segment fast forward" key, Manually move forward to the starting point of next continuous curve, when the spindle remains stationary.











:"Single needle return without load" key: Press the key, and one stitch will retract at single step without load; continuous backward movement is activated when this key is pressed and held.



:"Single needle forward without load" key: Press the key, and one stitch will go forward at single step without load; continuous forward movement is activated when this key is pressed and held.



:"Total stitch count setup" key: The number in the upper line indicates the stitch count of processing file, while the number in the lower line indicates the current stitch count. Press the key, when the "Jump stitch" setup window pops up.

Note: "Jump Stitch" window description:  ...  : Number input for set value;  : The set value returns to 0;  : The set value plus 1;  : The set value minus 1;  : Delete a digit from right to left  : Cancel current modification;  : Confirm current modification;



: Connection with wireless network has been established;



: Connection with cloud server has been established



:"Page left" key, Turn the page to the left to view memory files.



:"Page right" key, Turn the page to the right to view memory files.



:"File" key, View all memory files.



:"Reset" key, Press the key, when the shafts start to rotate, while the machine is reset.



:"Reference" key, Press the key to get into XY axes reference point setup page.

Frame : "Manual press frame up/down" key, Press the key to switch between lifting and pressing of press frame.

Foot : "Manual press foot up/down" key, Press the key to switch between lifting and pressing of press foot.

FootClip Setting : "Press foot thread clamp" setup key, Set press foot height or thread clamp strength. Note: This function is not available unless the press foot type is set to motorized press foot in parameter software.

Next : "Next interface" key, Press the key to get into test interface.

7.2.2 Test Interface Display Description

Bottom thread winding and other manual operations can be performed in the processing assist interface.

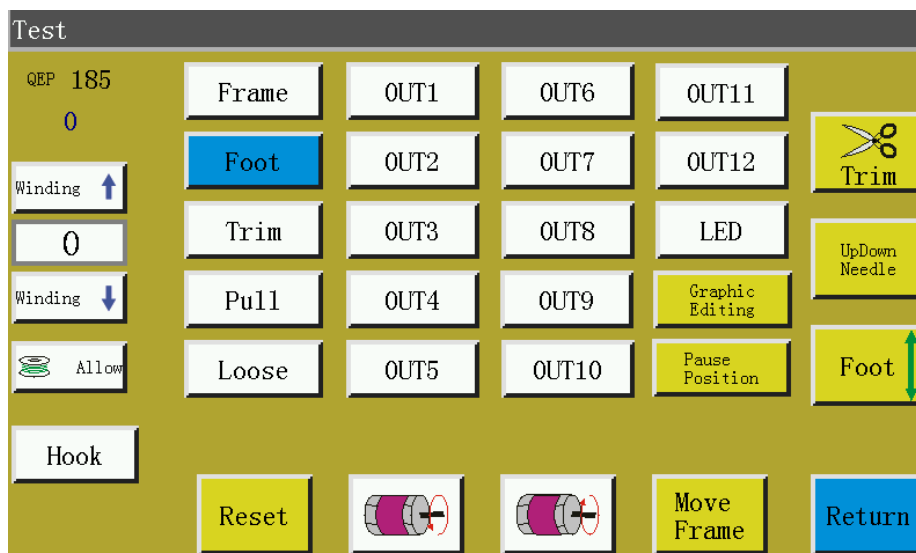

Key functions in the assist interface are described as follows:

Hook : Auto hook change. If the machine is designed with "auto hook change" feature, signal will be output for rotating hook change when the key is depressed.

Allow : "Bottom thread winding on/off" key: Press the key to switch between "allow" and "prohibit". Activate "Allow" and press the "Start" switch to start the winding operation, when the spindle will wind the thread at the speed set in this page. The winding will stop if the start switch or **Return** is depressed again or the set winding time elapses. "Prohibit" means thread winding is

prohibited.

0 : Show current rotational speed of spindle.

QEP 185 : Show current angle of spindle (0-999).

1500 : Set the winding speed of spindle.

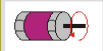
 : “Spindle REV” key: Press the key, when the spindle starts to reverse and move slowly.

 : “Spindle FWD” key: Press the key, when the spindle starts to rotate forward slowly.

UpDown Needle : “Needle rod up/down” key: Press the key to switch between upper position (the highest point of needle) and lower position (the lowest point of need).

Trim : “Trim” key: Press the key, when the machine sews one stitch to realize a complete trim operation.

Frame, **Foot**, **Trim**, **Pull**, **Loose** : Press the key, when the corresponding output is turned on; lift the key, when the output is turned off.

LED, **OUT1**...**OUT12** : Press the key, when the corresponding IO output function is always ON; press again to turn off the output. For some electric control, the LED lamp will be always ON.

Note: Please don't press and hold the electromagnet control output for long (e.g. **Trim **Pull** **Loose**); otherwise, the electromagnet connected with this output may get damaged due to overheating!**

Graphic Editing : Zoom, increase, decrease, and set the stitch length for each line segment of the current drawing. The interface is as follows:

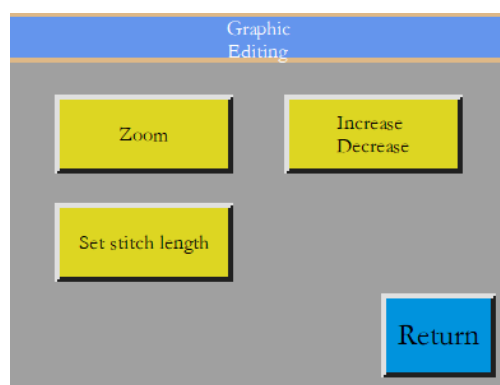

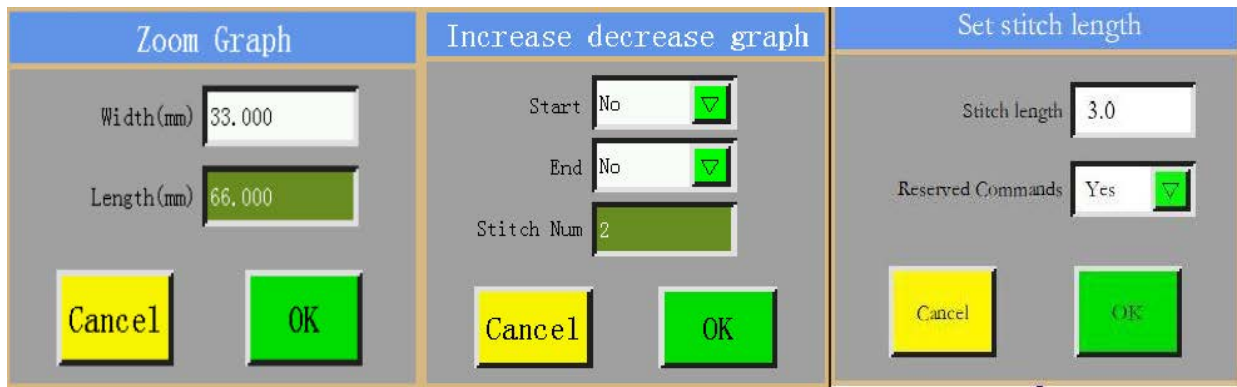

Zoom Graph: To reduce or enlarge the current graphics as a whole, the width and length are the actual width and length of the reduced or enlarged graphics.

Increase decrease graph: For the beginning or end of each line segment of the current figure, the change depends on the stitch length of needles increases or decreases. It means to increase if the value is greater than 0, and vice versa.

Set stitch length: Modify the length of the stitching needle of the current figure. Reserved Commands means that retain some functional code instructions inserted by users after modifying the length of needle spacing

Graphic Editing: Press the key to get into the suspension position interface that is used to set the positions (up to 6) of suspension during sewing operation.

Return: “Previous interface” key, Press the key to go back to the main interface of processing.

Move Frame: “Manual frame movement” key, Press the key to get into the manual frame movement operation interface.

Thread winding: Press touch key “Start” at the bottom of the screen in this interface, and confirm, when the spindle motor will rotate for thread winding at the set speed, while **Stop** key appears at original position of **Return**; click this key to stop winding operation. The winding operation can also be stopped by pressing “Start” and “Emergency stop” buttons. The speed can be regulated through **Winding** ↑ **Winding** ↓ during winding operation.

7.2.3 Display Instruction for Manual Frame Movement Interface

Click on **Next** and **Move Frame** successively in the main interface of processing to get into the manual frame movement interface. In the manual frame movement interface, it’s possible to move the frame manually and control the rotation of each shaft.

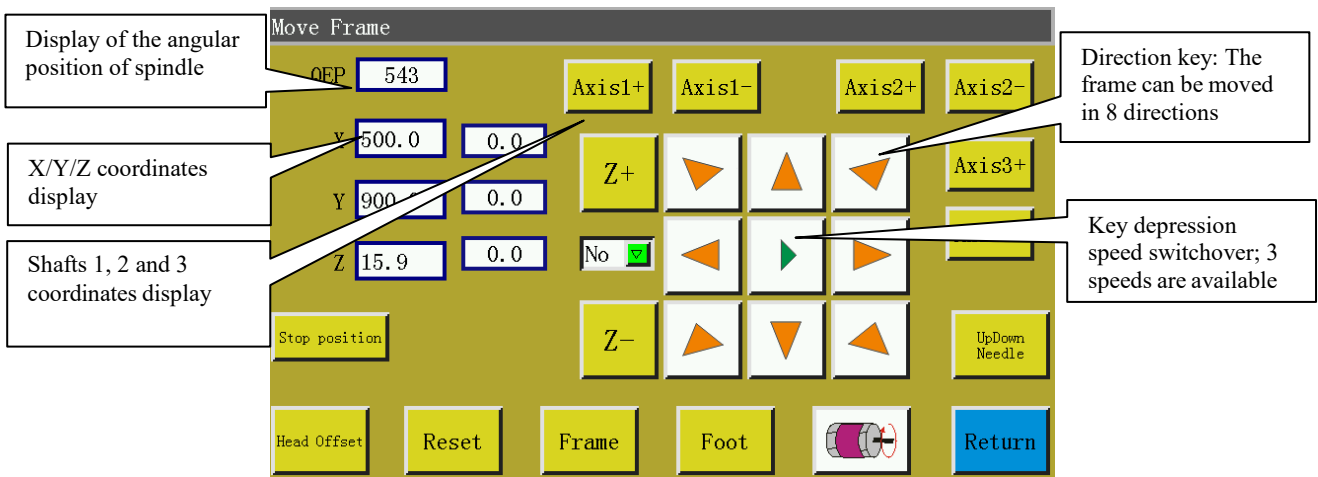



Key functions in the manual frame movement interface are described as follows:

: “Frame movement speed switching” key, Click to switch among low, medium and high speeds. Correspond to patterning speeds 1, 2 and 3 in “user parameters”.

: 8 direction keys, Move in X and Y directions.

“Z+”, “Z-”, “shaft 1+”, ... “shaft 3-”: Rotate corresponding shafts manually; some of the shafts have no effect on certain machines.

: The default is “No”, indicating that the manual frame-shift operation cannot be performed before resetting. You can select “Yes” to perform a temporary manual frame-shift operation before reset. If it has been reset, this function is invalid.

: The current X and Y coordinates are set to the stop coordinates of X and Y axes after resetting.

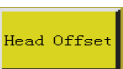
: Enter the head offset interface for setting the offset position of heads 2 and 3 in relation to head 1. Head 1 is a sewing head. Desired functions such as laser cutting head and brush head can be assigned to heads 2 and 3.

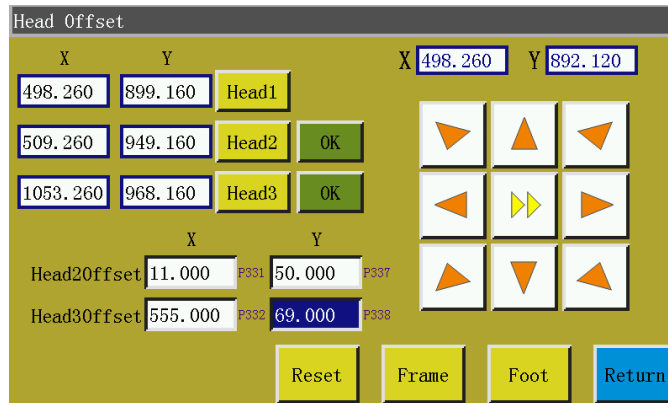

Click **Head1**, when the coordinates of head 1 become the coordinates employed in **X 498.260 Y 892.120**. Set the values of heads 2 and 3 in relation to head 1 below, and

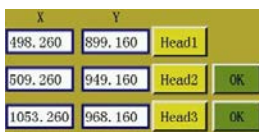

will change correspondingly; click OK to save the settings.



: "Needle rod up/down" key, Press the key to switch between upper position (the highest point of needle) and lower position (the lowest point of need).



:"Return" key, Press the key to return to the previous operation interface.

7.2.4 Display Instruction for Reference Setup Interface

Click **Base** in the main interface of processing to get into the reference point setup interface.

The template reference point can be set in this interface.

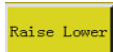
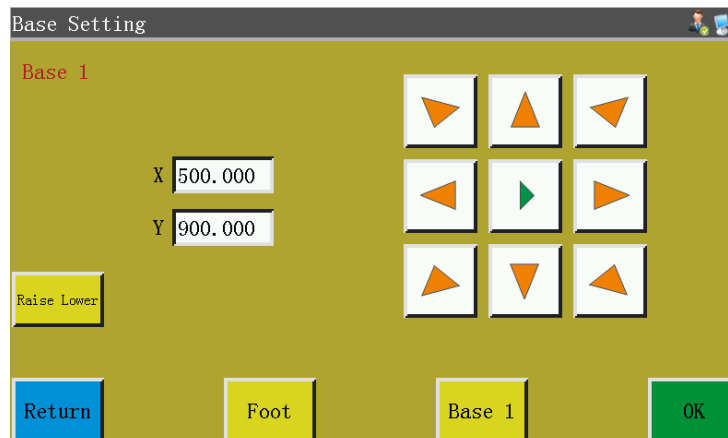

: Lifting function is mainly used for "rotary head" type machine, outputting IO corresponding to the set parameters (P249).High and low level switch each other.



: As mentioned earlier (all foot pressing functions on the interface are the same)

Reason for reference point setup: When the processing file generated through the software in upper computer is imported into the memory and previewed for the first time, the system puts the file at the center of the processing range (click the “Processing file preview area” to switch the display mode), and writes this position information into processing file. As shown in the figure below:

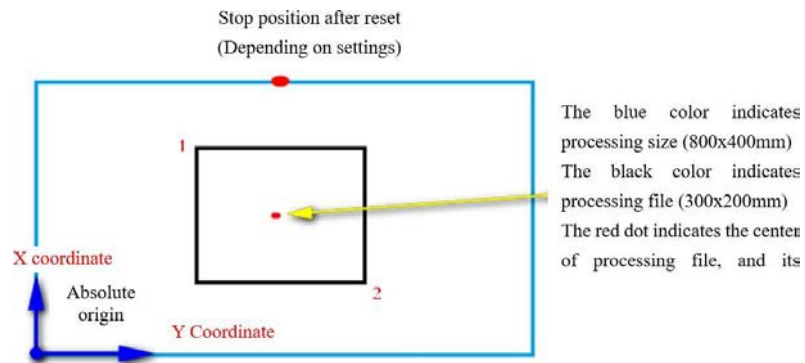

The fabricated template is placed on workbench in the position that may be as shown in the figure below:

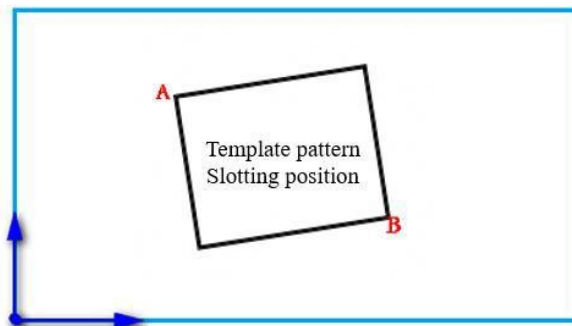

Hence, it's necessary to align reference point 1 with A, and reference point 2 with B. Adjust the position of processing pattern in the system so that it corresponds to the template slotting position.

Detailed steps are as follows:

- 1) Select the file for which the reference point should be set up in the main interface of processing, and place the corresponding template. Click Reset to enter the reference point setup interface, and the system will automatically move the frame to reference point 1.



If dual reference points are set up in upper computer software, the upper left corner of the interface will indicate "set up reference point 1". See whether the reference point 1 is located at template slot A; in the case of offset, click the arrow keys to move the point until they coincide with each other.

- 2) Click OK to finish the setup of reference point 1. The system automatically moves frame

to reference point 2, when the upper left corner of interface indicates "set up the second reference point". Click direction keys to move the frame so that reference point 2 coincides with the position of template B. To return to re-set reference point 1, click  key to switch to reference point 1 for setup.



- 3) Click  to finish the setup of reference point 2, when the system automatically returns to the main interface of processing. The system will write this position into processing file, while the processing preview area pattern will be adjusted to correspond to the position of template. Upon the completion of reference point alignment, additional alignment is not needed as long as you don't modify this file and template. If the upper computer does not set up dual reference points, the sewing start point will be taken as reference point 1 by default, in which case the system will return to main interface of processing after the alignment of reference 1. By setting up system parameters, it is possible that reference alignment is not needed at the first use. Please consult the manufacturer for detailed settings.

7.2.5 Process Statistics Interface Display Instruction

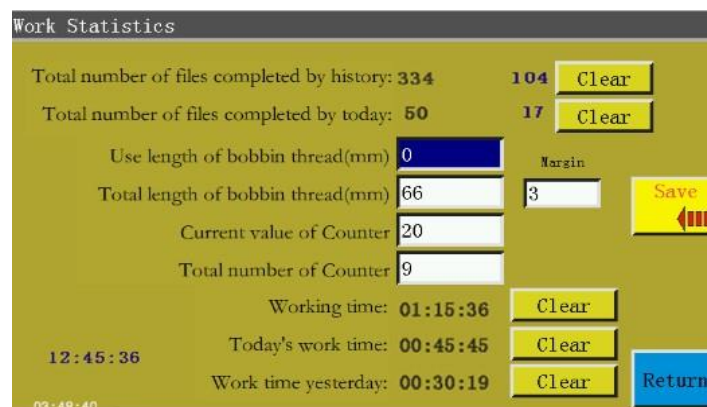
Click  or  in the main interface of processing to enter the processing statistics interface. In this interface, you can view the processing quantity, time, bottom thread length and other information.



The interface is described as follows:

Total number of files completed by history:   The number on the left represents the total number of processing times accumulated; The number on the right represents the total number of processing times in 7 days of the current figure. Click "Clear" to clear the total number of both processing times and 7 days of the current graphics.

Total number of files completed by today: **50** **17** The number on the left indicates the total number of processing times accumulated on that day. The number on the right indicate the cumulative number of processing times on the day of the current figure. Click "Clear" to clear the total number of processing times of the current graphics and the number of file processing times.

Use length of bobbin thread(mm): Refers to the length of the baseline that has been used up. After setting it to the, it will accumulate baseline length of the current file when processing begins.

Total length of bobbin thread(mm): Refers to the total length of the initial bottom line in the spindle. When winding, it can be estimated that the total length is equal to the average circumference of the spindle multiplied by the speed multiplied by the winding time

Current value of Counter: Refers to the total number of processed documents. Each time the processing is completed, it will automatically add 1, which cannot be closed.

Total number of Counter: Refers to the target number of times a processing document has been completed.

Working time: Show the total processing time. Just count "working..." state time.

Today's work time: Show the processing time of the day. Click Clear to clear 0.

Work time yesterday: It shows the processing time yesterday. Click Clear to clear 0.

3: Refers to the error margin of the remaining length of the baseline. (Baseline length detection device for special purpose).

12:45:36: The blue character in the lower left corner indicates the last processing time.

03:48:40: The white words in the lower left corner indicate the total time of starting this time.

7.3 Main Menu Interface

Press  key in main interface of processing to enter the main menu interface, as shown in the figure:

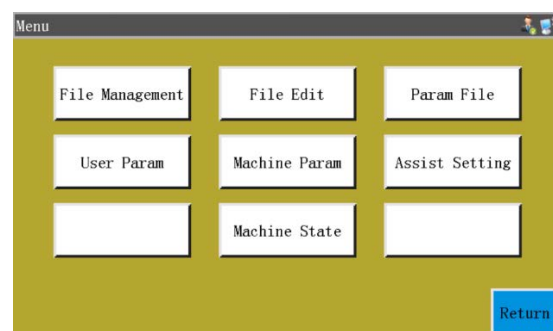

File management: Manage, import and export the files in memory and USB flash disk.

File edition: Create new sewing graphs or edit & modify original graphs.

Parameter file: Write parameters into the system, and export system parameters in the form of file; the transfer of files between memory and USB flash disk, etc.

User parameters: The parameters frequently used by user; parameters are adjusted based on processing requirements to realize convenient processing and improve processing efficiency.

Machine parameters: Only accessible to machine assemblers.

Assist settings: Used for processing assist settings and testing, etc.

Network file: (Temporarily unavailable)

Machine state: For remote administration device to report various status of machine for solutions.

Chapter VIII File Management

File management is performed to import, export and delete files in USB flash disk and memory. The system only recognizes the processing files with extensions .SLW. Processing files are created with PC graph edition software delivered with machine or through file capture.

8.1 Memory File Management

Press  key in main menu interface to enter file management interface as shown in the figure below:



The system memory can store up to 999 processing files, of which the total size shall not exceed 128M. Support file names in Chinese and English (case sensitive); each file name can consist of up to 15 Chinese characters or 30 characters (the displayed number of characters may vary depending on the interface). In the case of wrong format of processing file or file corruption, no preview is displayed here.



Click to select a file, when the selected file turns red; the selected file shall be handled as needed.

Key description:

: Copying file, Copy the currently selected file. File copy can be created by clicking

“Copy” and entering the new file name.

: Deleting selected file, Delete the currently selected one or more files.

: Sorting file, Insert the currently selected one or more files into designated location. For example, select “002:TEST2”, click , enter “1” into the pop-up dialog box, and click "OK". The file ranks first and turns into “001:TEST2”.

: “Electronic tag and barcode write” key, The function is determined by “User parameters” - “Other settings” - “Template recognition mode: By file name/file number”.

If the recognition is by “file number”, it means the processing file is matched by scanning barcode with scanner. Method of binding processing file to barcode: Click this key after selecting the processing file, enter the desired barcode value into the pop-up “Barcode” window, and click OK to return. At this point, the set barcode is displayed on the graph.

If “By file name” is selected, it means the file name in IC card is recognized using electronic tag reader so as to match processing file. Method of binding processing file to electronic tag: Click this key after selecting the processing file, and click “Yes” in the pop-up confirmation window; when the card reader beeps once, it means the file name has been successfully written into electronic tag; at this point, the interface title bar shows that file name.

: Select all files, Select all files under the directory.

: Export file, Copy one or more files from the memory into the root directory of USB flash disk. If a file exists with the same name in the USB flash disk, a message will appear reading “The file already exists. Do you want to overwrite it?”

: The current storage space occupancy ratio, through which you can make clear understanding of the storage occupancy.

:File in USB flash disk,Click to enter the “U-disk file” interface.

8.2 Management of Files in USB Flash Disk

Insert the USB flash disk, and press  key in memory management interface to switch to the USB flash disk file management interface as shown in the figure:



USB flash disk file management supports up to 15 Chinese characters or 30 characters display. If USB flash disk is accessed through file management, the files and folders in .slw formats under root directory of the USB flash disk are displayed by default; if USB flash disk is accessed through

parameter file, the files and folders in .xhp format under root directory of USB flash disk will be displayed by default. Support multi-level folder operation; it is recommended that folders be used for classification management where there are a lot of files.

Click to select a file, when the selected file turns red; the selected file shall be handled as needed.

Key description:



:Import files, Copy the selected one or more files from USB flash disk to the memory space, and replace the file with the same name (if any).



:"Delete" key,Delete one or more selected files.



: Select all the files in the U-disk directory with the full key.



:Memory file, Click to return to the memory file interface.



:"Return" key,Return to the main menu interface or parent folder.



:Click back to the previous directory.

Note: If the processing file in .SLW format can't be recognized or imported, Please upgrade the motherboard program directly to the latest version. See section 8.8.

Chapter IX File Editing

File capture (patterning) is used to create new processing files, or to add sewing paths, etc. to existing processing files. Where it's necessary to create complex and accurate graphs, the included sewing control software is recommended for better results.

9.1 Main Interface of File Editing

Press  key in the main menu interface to enter the main interface of file editing as shown in the figure:

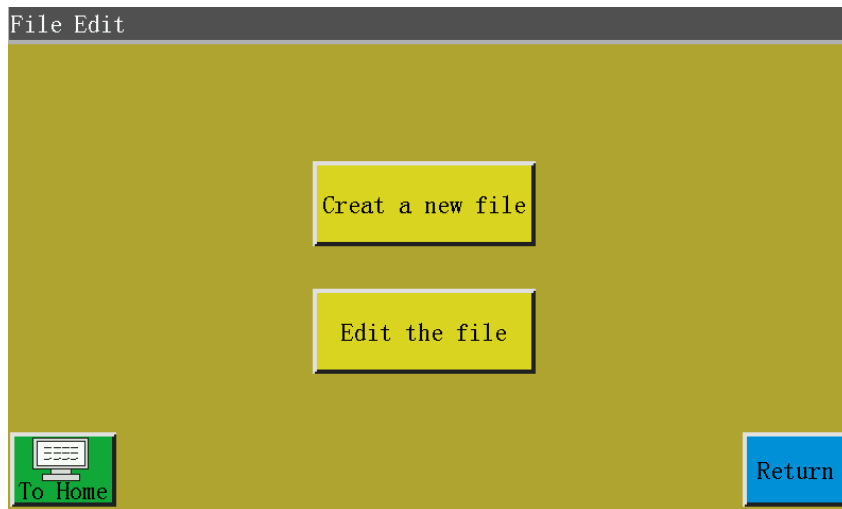

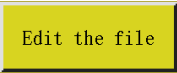

: Create new capture file.

: Make modification or other edits based on the file selected in the main processing interface.

9.2 Capturing Graphs

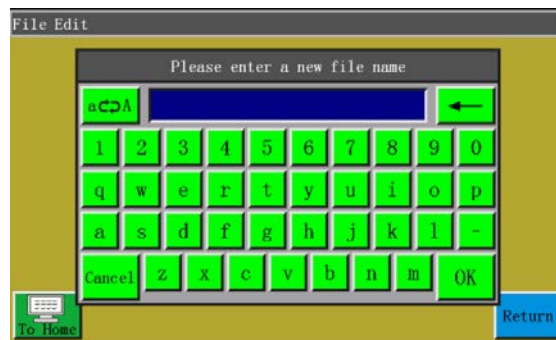
Pressing  in file editing interface pops up a new file naming window. See the figure below:

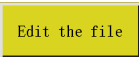

After entering the name, press  or  to enter graph capture interface as shown in the figure below:

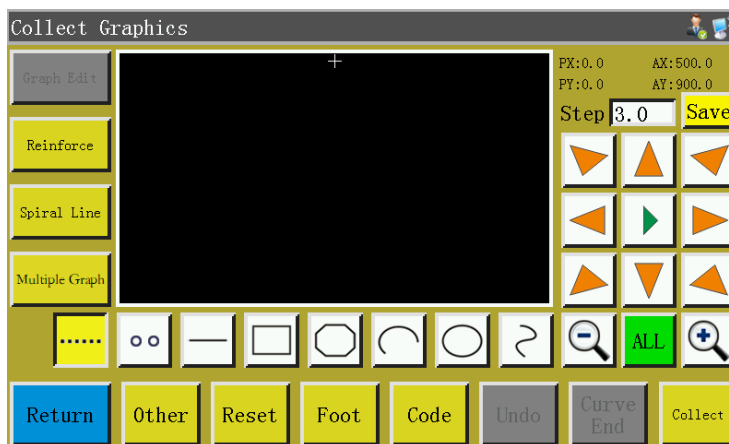



The function keys of capture interface are as follows:

"PX", "PY": Indicate the X and Y coordinates of current cursor point with respect to the previous capture point.

"AX", "AY": Indicate the coordinates of current cursor point with respect to the absolute origin.

: The distance between stitches in sewing settings; the default is 3.0mm, while the range is 1~50mm.

 "Frame movement speed switching" key: Click to switch among low, medium and high speeds.

: "Graph Edit" key. The key will only light up when graph is captured. Press the key to enter the curve editing interface for curve editing.

: Reinforcement preset key, key into reinforcement preset settings, open preset and click "OK", collection page "Reinforcement preset" into blue characters. Close the default and click "Cancel" to change the "Reinforce the default" of the collection page to black, and the default is "Close". When the reinforcement preset is set up, the corresponding reinforcement is automatically carried out for each new line segment collected. If you want to reinforce the edited graphics, you can operate in "Graph Edit".

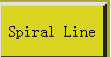
: "Spiral Line" key. The key setup requirements automatically generate helix graph.

: "Multi-Graph "key. Press the key to get into multiple sewing settings.

: Single needle acquisition key, acquisition needle length, the maximum length is not more than 12.7 mm.

: "Idle capture" key. Press the key once; when the background turns yellow, the current capture segment is idle. It is displayed with dotted line.

: Press the key once, when the background turns yellow, the current capture segment is straight line.

: Press the key once, when the background turns yellow, the current capture segment is rectangle (determined with 2 points).

: Press the key once, when the background turns yellow, the current capture segment is polyline segment.

: Press the key once, when the background turns yellow, the current capture segment is arc (arc determined with 3 points).

: Press the key once, when the background turns yellow, the current capture segment is circle (circle determined with 3 points).

: Press the key once, when the background turns yellow, the current capture segment is curve (curve determined with more than 3 points).

: "Zoom-out" key. Press the key to zoom out of the captured file graph. Click on the graph preview area to move the graph.

: "Zoom-in" key. Press the key to zoom into the captured file graph.

: "Display switch" key. Press the key to switch between full-scale display and proportional display.

: "Insert function" key. Press the key to access function code inserting operation.

: "Cancel capture" key. Press the key once to cancel the capture of previous step.



: "Curve generation" key. When polyline segment and curve are captured, press the key to finish the capture of current segment.



: "Capture" key. Press the key to determine the current cursor location or finish the capture of current segment. If some areas of the generated graphs go beyond the processing range, they can't be generated.



: "Save file" key. Press the key to save the current capture file. The saved file can be displayed directly in the preview area of main interface.

9.3 Idle Capture

Press  key in "capture graph interface, when the key background turns yellow (idle mode is activated automatically when the capture interface is activated for the first time), which means the current segment of capture is in idle mode (idle: Only frame is moved, while the spindle is not sewn) as shown in the figure below:

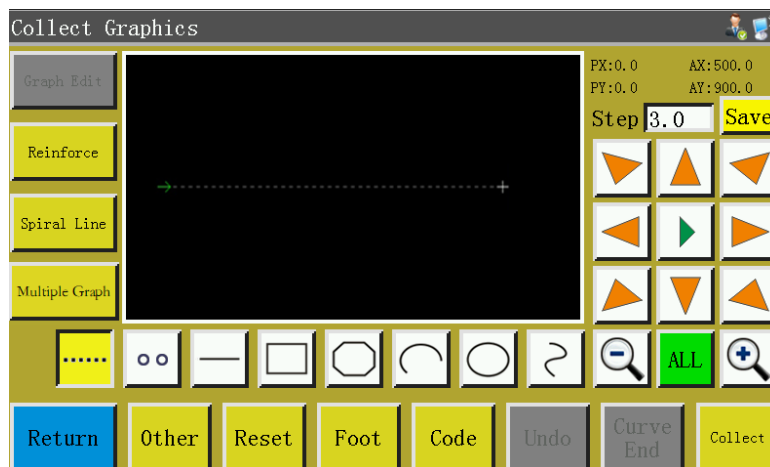

In the case of idle capture, two points generate an idle segment.



The absolute origin or the end point of previous capture segment is the first point of idle capture and displayed as red cursor. Press the key to move cross cursor to desired position, and press  key to generate idle segment.

If it's necessary to insert function code at the end of this segment, please refer to the operation procedure for function code setup. This operation can be performed at any time before the generation of graph.

9.4 Single needle acquisition

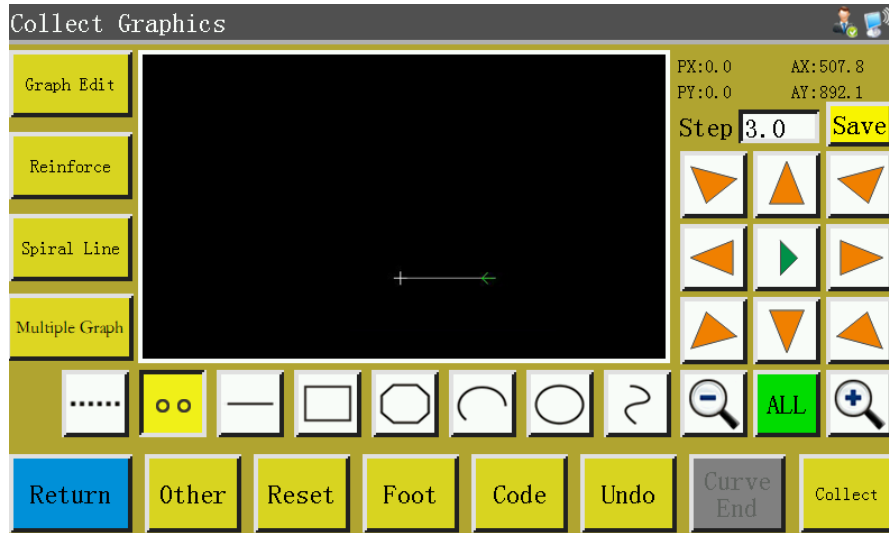
Depress the  key in main interface of file capture, when the key background turns yellow, which means the capture of current segment is in line segment mode as shown in the figure:



Taking the length of one needle per acquisition as a line segment, the maximum length is 12.7 mm, and the acquisition of more than 12.7 mm is invalid. Please refer to PX, PY value operation in the upper right corner. Click on the  key to create a needle length, press the  key to enlarge it, you can clearly see the collected line segment.

9.5 Straight Line Capture

Depress the  key in main interface of file capture, when the key background turns yellow, which means the capture of current segment is in straight line mode as shown in the figure:

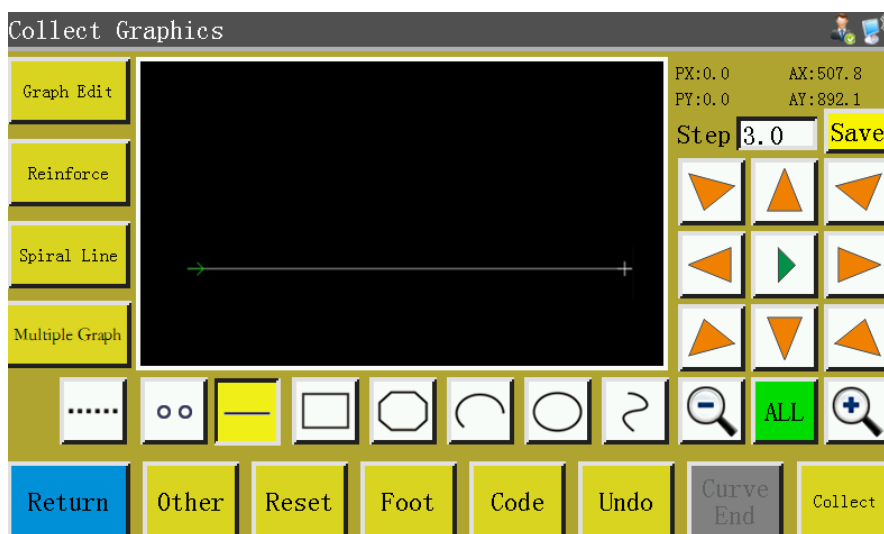

In the case of straight line capture, two points generate a segment of straight line.

The absolute origin or the end point of previous capture segment is the first point of straight line capture. Press the key to move cursor to desired position, and press  key to generate straight line.

9.6 Rectangle Capture

Press  key in main interface of file capture, when the key background turns yellow, which means the current segment capture is in rectangle mode as shown in the figure:

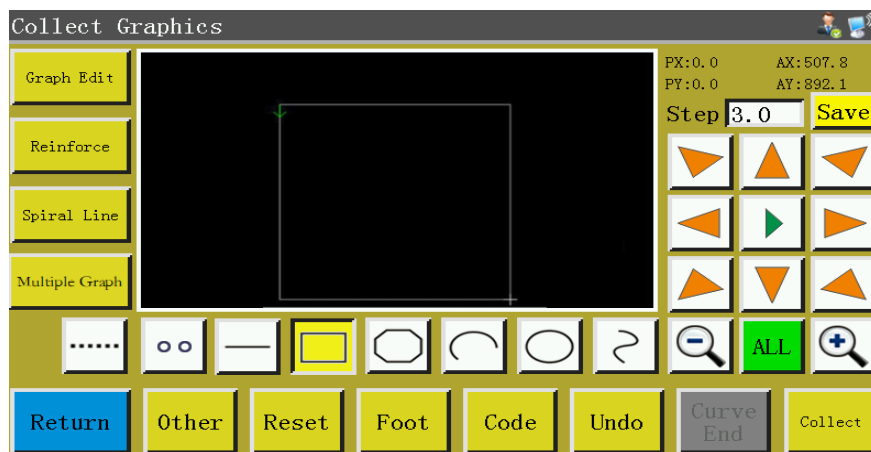

In the case of rectangle capture, two points with different X and Y coordinates generate a rectangle.



The absolute origin or the end point of previous capture segment is the first point of rectangle capture. Press the key to move cursor to desired position, and press  key to generate rectangle.

9.7 Polyline Segment Capture

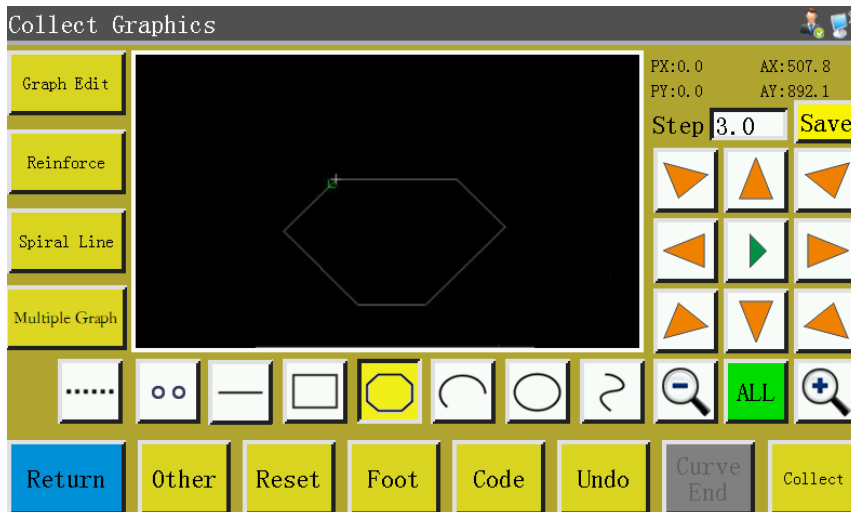
Press  key in main interface of file capture, when the key background turns yellow, which means the current segment capture is in polyline segment mode as shown in the figure:



In the case of polyline segment capture, up to 127 consecutive points can be handled, and the line segment will be generated by two points determining straight line.

The absolute origin or the end point of previous capture segment is the first point of polyline segment capture. Press the key to move cursor to desired position, press  key to identify the capture point, and move for several times to determine capture points; upon completion, press  key to generate the polyline segment linking the points up.

9.8 Arc Capture

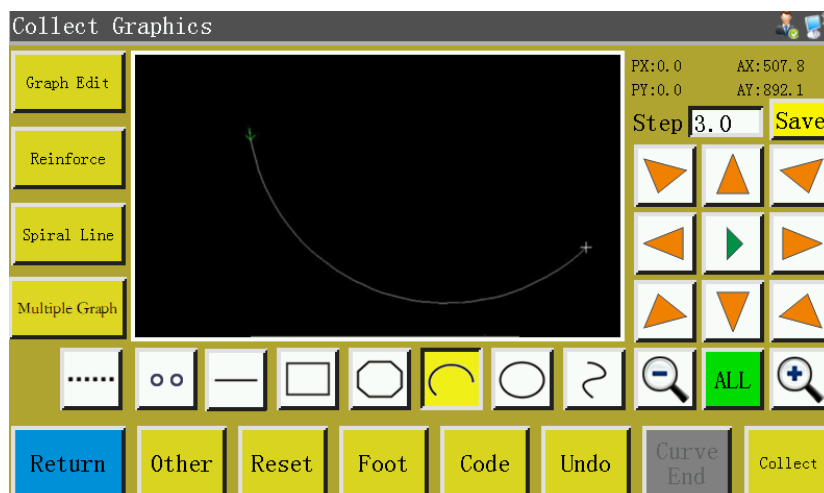

Press  key in main interface of file capture, when the key background turns yellow, which means the current segment capture is in arc mode as shown in the figure:



In the case of arc capture, any 3 points that are not in the same straight line generate an arc: The first point is the start point of arc, the second point being the height reference point of arc, and the third

point being the end point of arc.

The absolute origin or the end point of previous capture segment is the first point of arc capture.

Press the key to move cursor to desired position, and press  key to identify the arc height reference point; press key to move to the desired position, and press  key to determine the end point of arc to generate the arc.



To draw accurate arc, reference coordinate values are needed, and it's necessary to make the height reference point in the perpendicular bisector of line between start point and end point.

9.9 Circle Capture

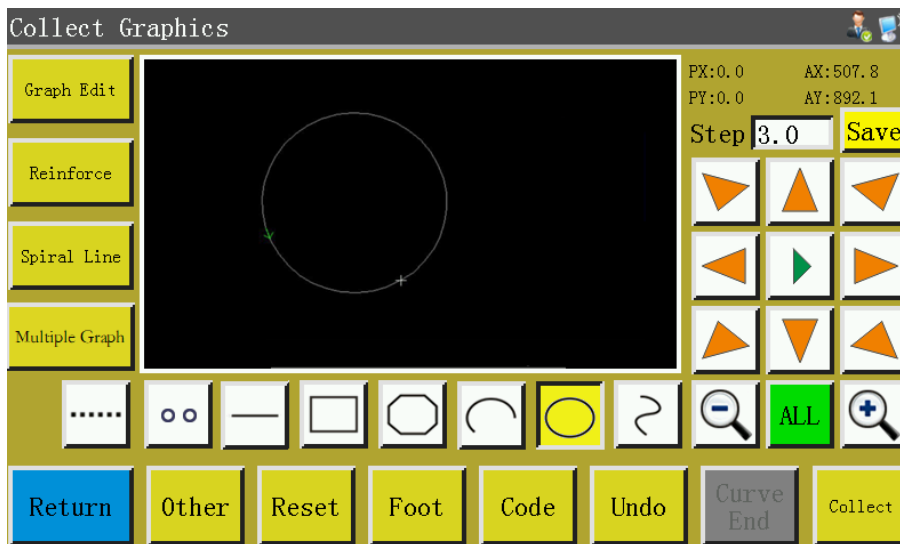
Press  key in main interface of file capture, when the key background turns yellow, which means the current segment capture is in circle mode as shown in the figure:



In the case of circle capture, any 3 points that are not in the same straight line generate a circle. The processing sequence: The first point (start point) > The second point > The third point > The first point (end point).

The absolute origin or the end point of previous capture segment is the first point of circle capture (the start point and end point of circle). Press the key to move cursor to desired position, and press  to identify the second reference point; press the key to move to the desired position, and press  key to determine the third reference point to generate the circle automatically. In the meantime, the press frame moves to the start point of circle.

Where accurate circle is needed, it is recommended that the distance between the first and second points should be the diameter of circle; the third point should be in the perpendicular bisector of the diameter line determined by the first and second points, and its distance from the diameter line should be the radius of circle.

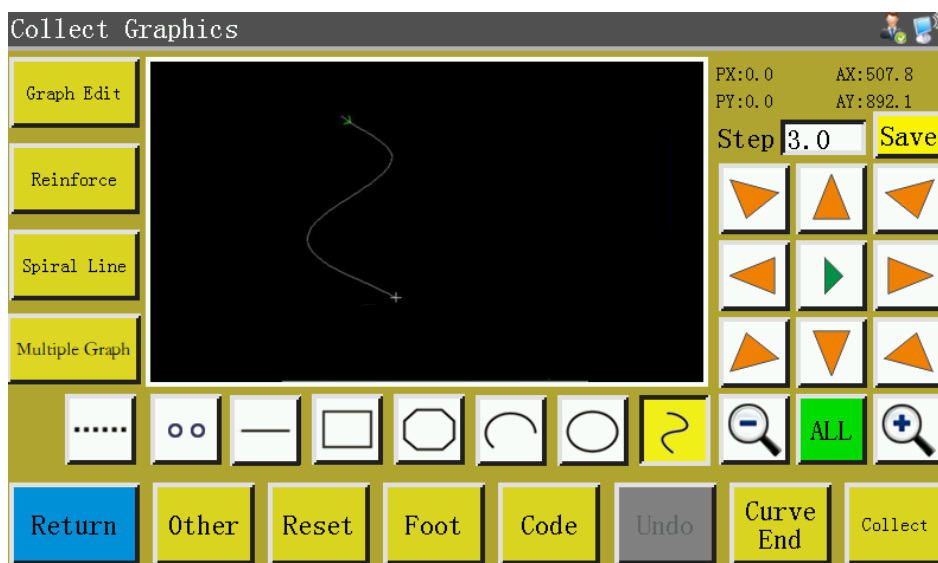

9.10 Curve Capture

Press  key in main interface of file capture, when the key background turns yellow, which means the current segment capture is in curve mode as shown in the figure:



In the case of curve capture, up to 127 consecutive points can be handled, and the Bezier is generated by the degree of arc of the neighboring 4 points. The capture point shall be as dense as possible at the turning so as to achieve optimal curve effect. The capture of less than 3 points can generate curve.

The absolute origin or the end point of previous capture segment is the first point of curve capture.

Press the key to move to desired position, press  key to identify the capture point, and move for several times to determine capture points; upon completion, press  key to generate the curve.

9.11 Multiple Curves

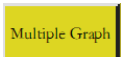
In the case of file capture, if the current capture curve (except idle and straight line capture) requires multiple sewing, it's necessary press  key to get into multi-curve setup interface as shown in the figure:

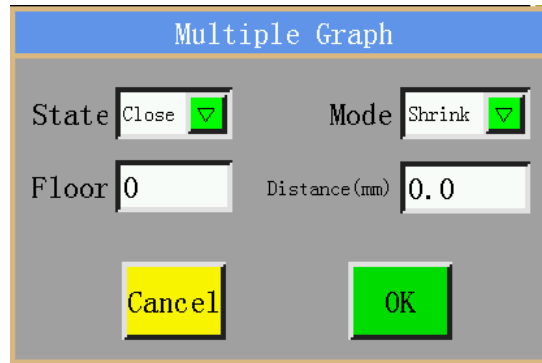

State  : State ON/OFF. Determine whether multi-curve sewing is employed or not for next capture.

Mode  : Mode selection. There are two modes available for selection, i.e. internal shrinkage and external expansion. Internal shrinkage means the offset shrinkage at designated spacing based on capture graph; external expansion refers to the offset expansion at designated spacing based on capture graph.

Floors : Indicate the increased number of curves; the range of entry: 1~20.



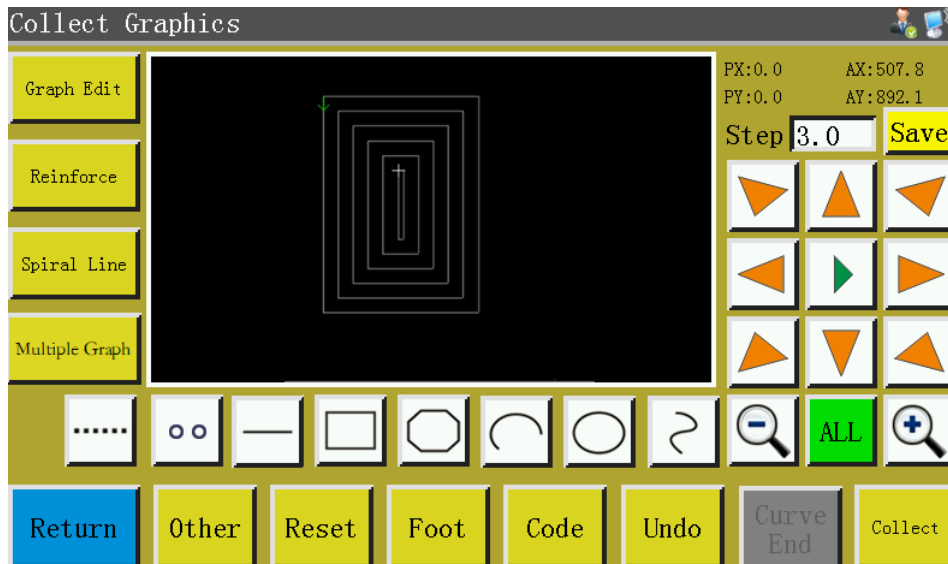

Distance(mm) : Indicate the distance between stitch threads; the range of entry: 0.1~20.0mm.

Select multiple sewing as needed, and set the offset distance and the number of offset layers. Upon completion of the setup, press  key to save current settings and go back to the main interface of capture graph.

For instance: Set the state to "ON", the mode to "internal shrinkage", the number of layers to "5", and the spacing to "3.0"; click "OK" and perform a "rectangle capture" to get the curve as shown below; all the 5 rectangles inside are generated on a multi-curve basis.



9.12 Reinforcement Preset

If current file capture segment requires start & end or overlap reinforcement sewing, press  key to enter reinforcement setup interface as shown in the figure below. Upon completion of setup, the  key must be depressed to put the settings into force. If the subsequent graphs require no reinforcement, you can click  or set the value to 0, and press .

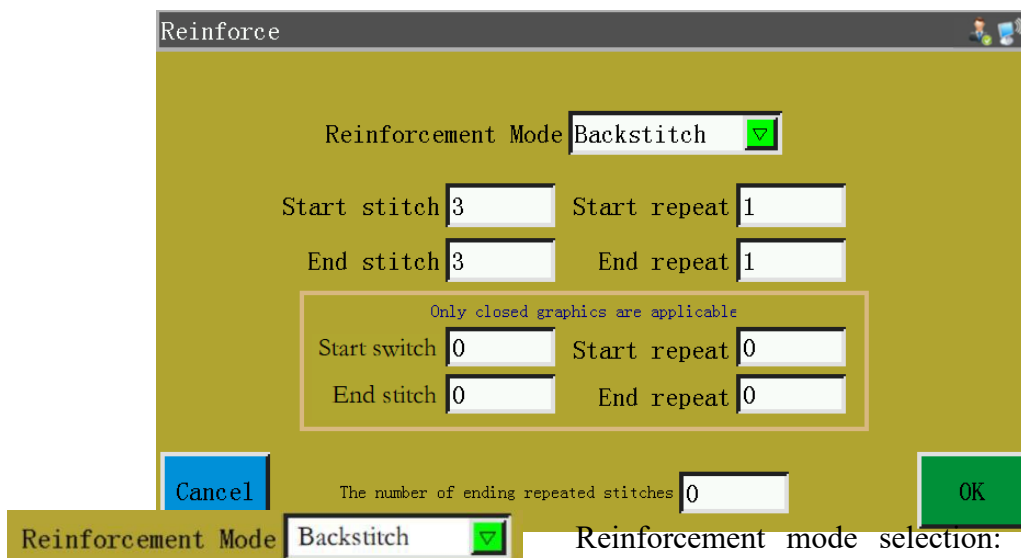

Reinforcement mode selection: There are three reinforcement modes available, i.e. backstitch, shrinkage suture, and lambdoidal suture.

Backstitch: Perform overhanding near the start point or end point of sewing curve for reinforcement. Set the backstitch count and stitch count as needed. If the set value is 0, no backstitch will be performed. Upon completion of the setup, press  key to save current settings.

Closed graph reinforcement means to sew designated number of stitches forward after the end point (i.e. stitch start point) is reached, and then return to the stitch start point; overlapping reinforcement is performed between these two points. Closed graphs refer to enclosed graphs composed of circle, rectangle, and polygon whose start points are completely coincident with end points.

Shrinkage suture: The stitch length is reduced based on the default stitch length for bar tacking sewing. If the default stitch length is 3mm, the parameters set as shown in the figure below mean all stitch lengths within the distance of 9mm from start point of curve are 1.5mm, while the stitch length in other parts is 3mm by default.

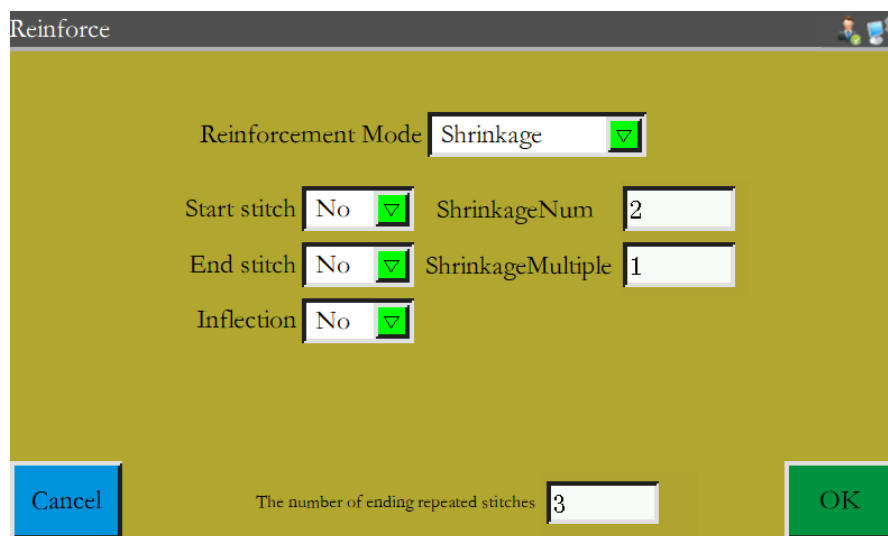

The number of ending repeated stitches 3: Repeated stitches are required at the end of the line segment.

Lambdoidal suture: V or N-shaped bar tacking sewing. The parameters set as shown in the left figure below bring about the reinforcement effect shown in the right figure.

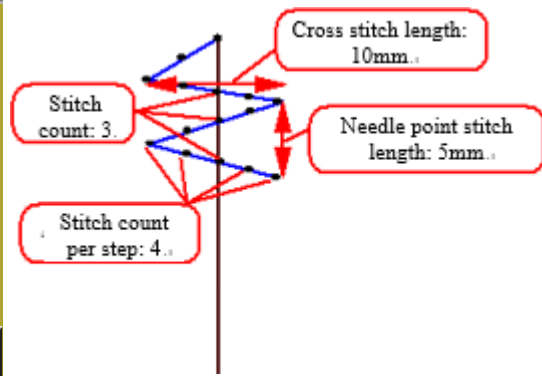
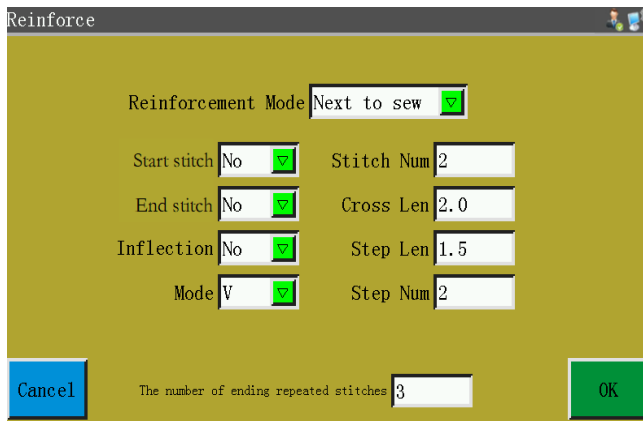

9.13 Function Code

If it's necessary to add function code the latest completed capture segment during file capture, you can press **Code** key to enter function code setup interface as shown in the figure:

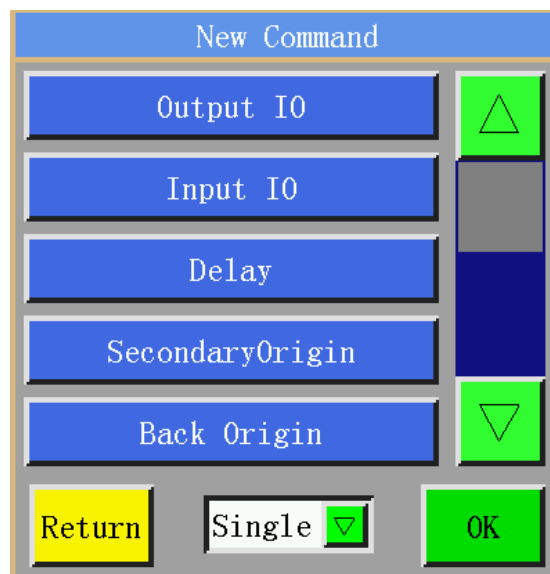
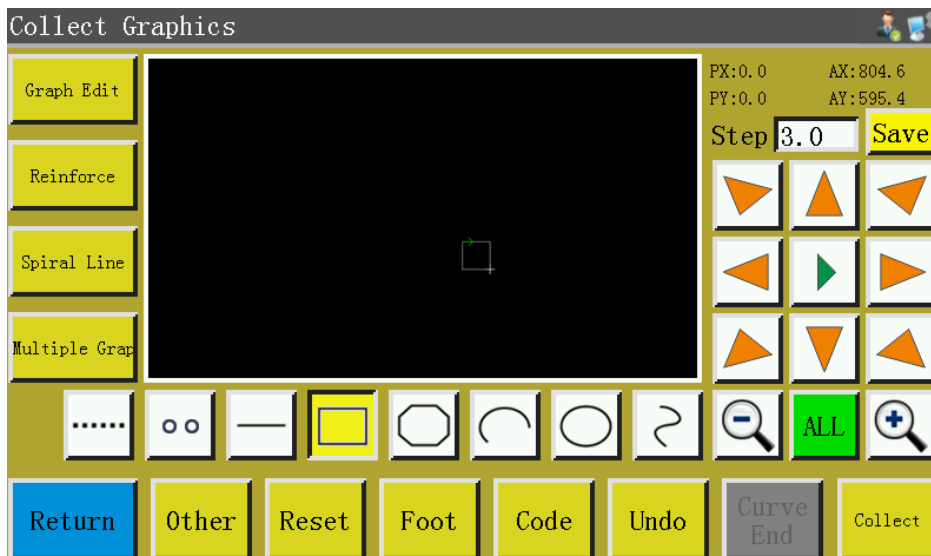

There are 25 function codes:

Output IO : Set the IO number to be output and its high and low levels; when the function code is encountered, the corresponding IO outputs corresponding level.

Input IO : Set the level for which the entered IO number should be detected. If the function code is encountered, subsequent operations shall be performed when the corresponding IO is at high or low level.

Delay : Set the delay time. The delay time that corresponds to the "single point" or "all points" function code.

SecondaryOrigin : Move directly to the set sub-origin position.

Back Origin : Return to the stop position after reset.

Up Pause : Upper pause function code; when this function code is encountered, the spindle stops at upper stop position.

Down Pause : Lower pause function code; when this function code is encountered, the spindle stops at lower stop position.

Main Speed : "spindle speed" instruction. It changes the current working sewing speed temporarily.

Move Speed : The "idle speed" command temporarily changes the current working idle speed.

Reset Speed : The "Recovery Speed" instruction restores the speed at which the preamble is modified by the "Spindle Speed" instruction to the working speed set by the interface.



Cut : Trim function code; when this function code is encountered, the thread is cut without stopping the spindle.

Up Table : when this function code is encountered, the press frame goes up, while the spindle stops at upper part.

Down Table : when this function code is encountered, the press frame goes down without spindle stopping at upper part.

- Z Axes Speed** : The "Z Axes speed" instruction temporarily changes the speed of Z axis.
- Rotate** : "Rotate along the trajectory" command, "Cutting trajectory" is used for rotary cutting of cutter, and "Sewing trajectory" is used for rotary sewing of machine head.
- RotateEnable** : The "Rotation Enabler" command temporarily closes or turns on the "Rotation along the Track" function.
- Frame Pause** : Detection of the current frame pressing state, when the frame pressing is lifting state, stop working and error "frame pressing is not pressed down".
- XY ABS Move** : Absolute motion function code; when this function code is encountered, XY move absolute to each other.
- Foot Height** : "Pressure foot height" command, temporarily changes the pressure foot height.
- Cancel Cut** : Cancel the next trimming operation.
- ClipLine 1** : Motor thread clamp function code; the thread clamp strength when the function code is encountered.
- ClipLine 2** : Motor thread clamp function code; the thread clamp strength when the function code is encountered.
- Turn Start** : Knee start function code; when this function code is encountered, knee is started
- Turn Speed** : Knee speed function code; when this function code is encountered, the spindle rotates at the function code speed.
- Turn End** : Knee end function code; when this function code is encountered, knee sewing comes to an end while the sewing speed is restored.

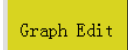
Press the key to add function code as needed; choose "single point" or "all points" for adding function code; select necessary instructions; set the corresponding requirements; click "Save" to add.

Alternatively, you can edit the graphs in capture graph interface, click  to enter graph editing interface, use  to choose the graphs to be handled (the graphs turn blue when chosen),

and click  to get into the following interface:

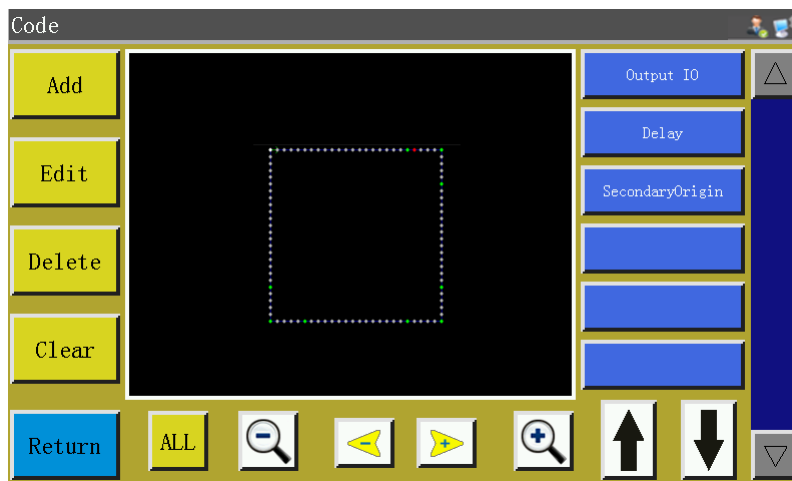

The graph is displayed in the form of needle points in this interface; select the position you want to edit (when a certain needle point turns red), when function codes can be added, edited, deleted and removed at the location of that needle point. When a function code is assigned to a certain point, that point will turn green. Click on this point, when the set function code appears on the right.

9.14 Graph Editing

"Curve editing" means to edit the captured graphs more comprehensively.

light up  after the graph is edited, which indicates the editing is available. Click

 to enter the following interface:

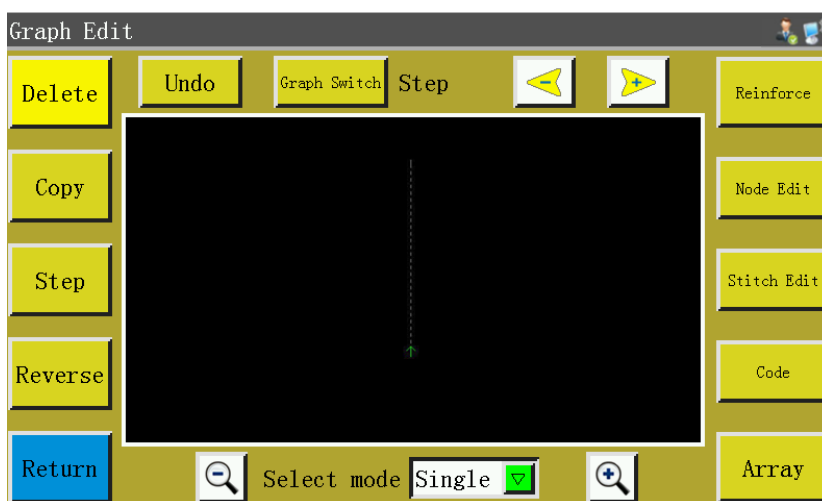

The function keys can't be edited unless the graphs to be handled are selected (turn blue if chosen)

using .

Undo : Revoke key, back to the state before the last modification.

Delete : Delete the currently selected graph

Step :Set the stitch length of graph to be handled (the stitch length ranges from 1 to 50)

Reverse :Reverse the sewing process of the selected graph, that is to say, the stitching is performed in reverse order.

Copy : Select the image to be copied and set its offset, that is, determine the location of the replicated image, as follows:

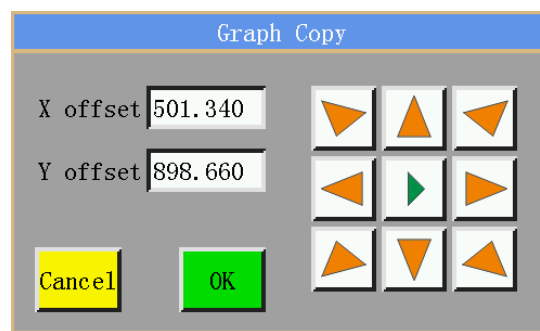

The effect before and after copying is as follows:

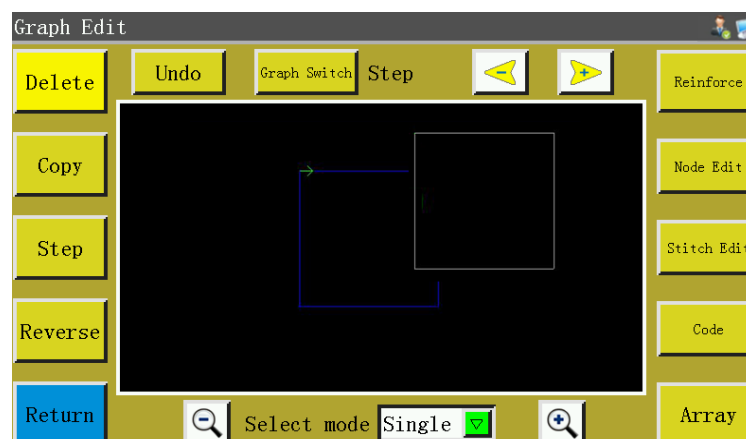
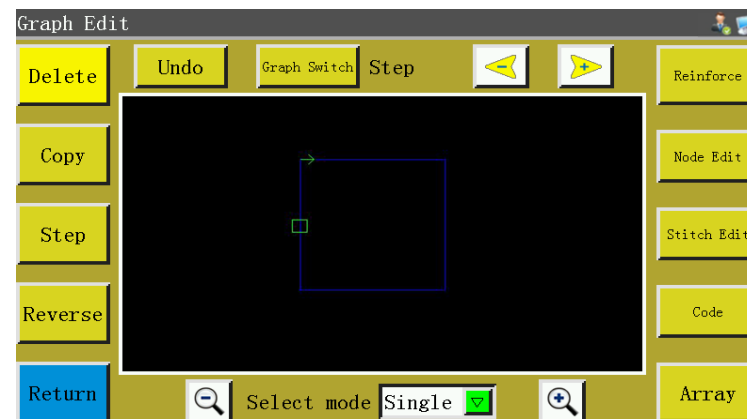

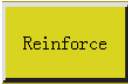

: There are three reinforcing modes: inverted joint, shrinkage joint and herringbone joint. See 4.12 for details.

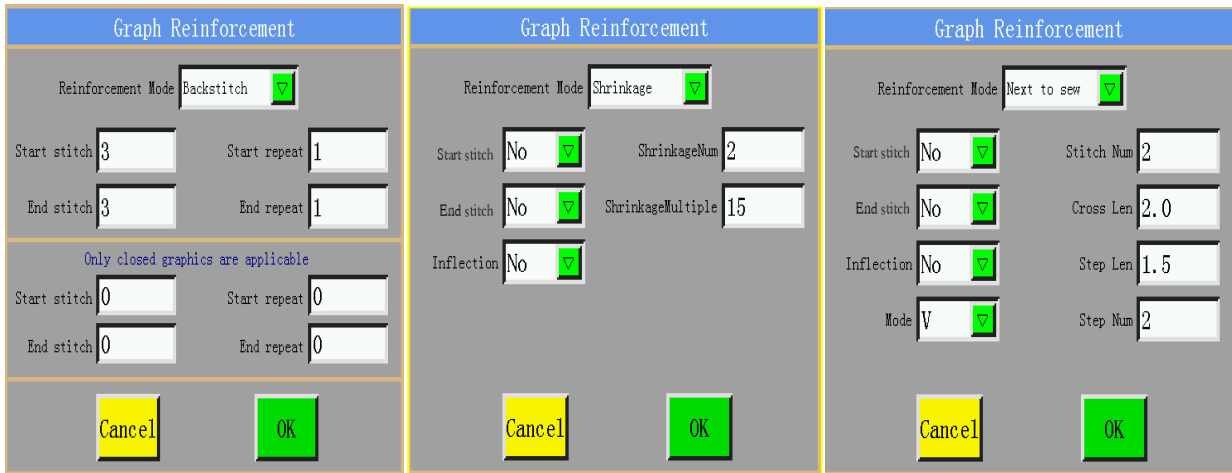

: Key to insert function code . See 4.13 for details.



: According to the set number of rows and columns and spacing, the alignment graph is automatically copied.



Represents the direction and arrangement of array graphics.

In mode 1, the graph matrix is generated according to the set number of rows, row spacing, column number and column spacing. The first point (X1, Y1) represents the offset of the initial position of the array.

In mode 2, according to the number of rows, columns and array area, the row spacing and column spacing are automatically calculated and the graph matrix is arrayed. The array region is the starting position of the first (X1, Y1) array and the height and width of the second (X2, Y2) array. The two points are diagonal vertices of the positive rectangle, and then the array region of the positive rectangle is calculated.

In mode 3, according to the set number of rows, columns and array area, automatically calculate row spacing and column spacing and array graphics matrix. The array region is the starting position of the first (X1, Y1) array, the width and tilt angle of the second (X2, Y2) array, and the height of the third (X3, Y3) rectangular region. The rectangular (rectangular or non-rectangular) array region is calculated from the three points.

Note: Click 2 to switch different modes

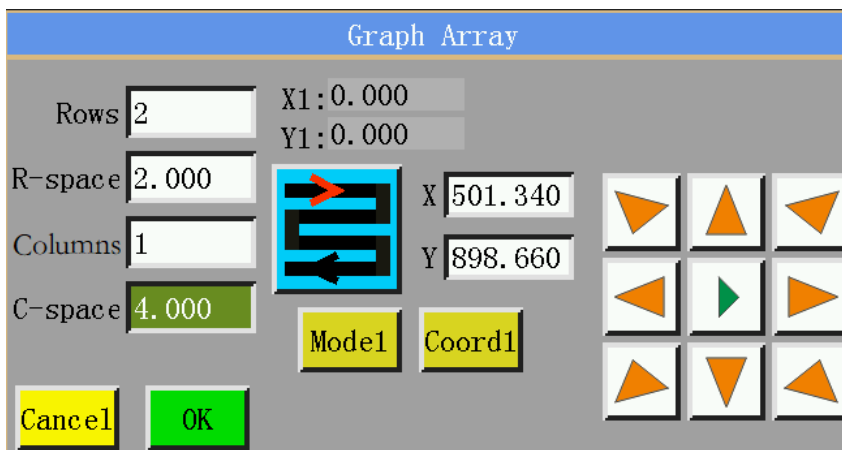

Stitch Edit: Click this key after selecting the graph, when all needle points are displayed on the graph; the interface is as follows:

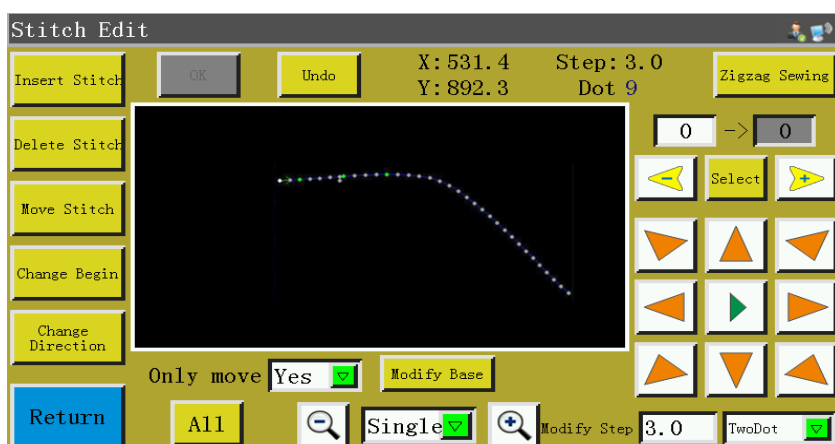

A certain needle point can be added, deleted, translated or changed. (When a point turns green, it means the function code has been assigned to that point)

Add needle point and translation needle point: Select this function, then select a point through , the selected needle point becomes red, move the cursor to the position where needle point needs to be added or translation needle point through the direction key, and then click the "OK" key to complete the corresponding operation. (Note: **Insert Stitch** and **Move Node** buttons indicate that the function is on when it is in embedded state or the background is brown. The function can be turned off by adding needle points or translating needle points continuously, and then clicking to restore to the yellow background again.)

Delete needle point: Turn a point into a red one, and click on "Delete needle point" to delete that point.

Change start point: Turn a point into a red one, and click "Change start point" to set that point to

the start point. (Closed graphics only)

Change direction: Change the sewing direction of graph.

Modify Base page as follows:

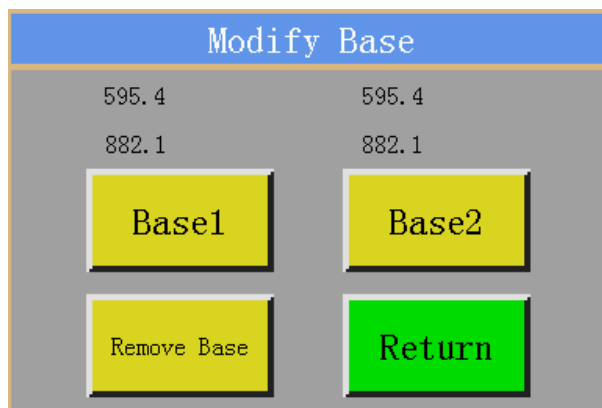

Modify Base: Set the current selected pin point as the reference point of the graph, the reference point 1 as the reference point 1, the reference point 2 as the reference point 2, and the clearance reference point to clear all the reference points that have been set.

Zigzag Sewing: Select "multiple choices" in , select more than two neighboring points that should be subjected to zigzag stitching. Select all options to indicate that the entire line segment is modified to a zigzag sewing. (Tip: When you can't see the needle point clearly, you can enlarge the image to the appropriate size by enlarging key.)



Set up the parameters of zigzag stitch,  zigzag patterns are in V shape or N shape.

Click , when the result is as follows:

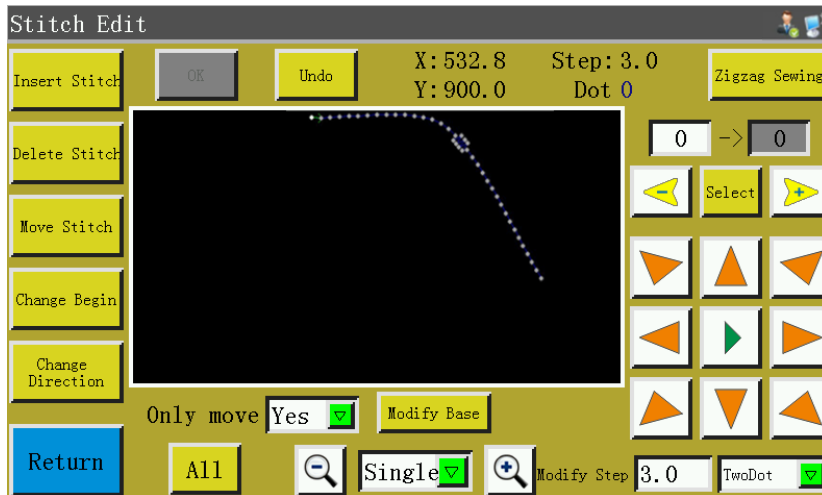

Node Edit

: The entire curve is presented in the form of many nodes so that the curve can be changed by adding, deleting and translating the nodes. Moreover, even the start point and the direction of the entire curve can be changed (the key operation mode is the same as needle point editing). The interface is as follows:

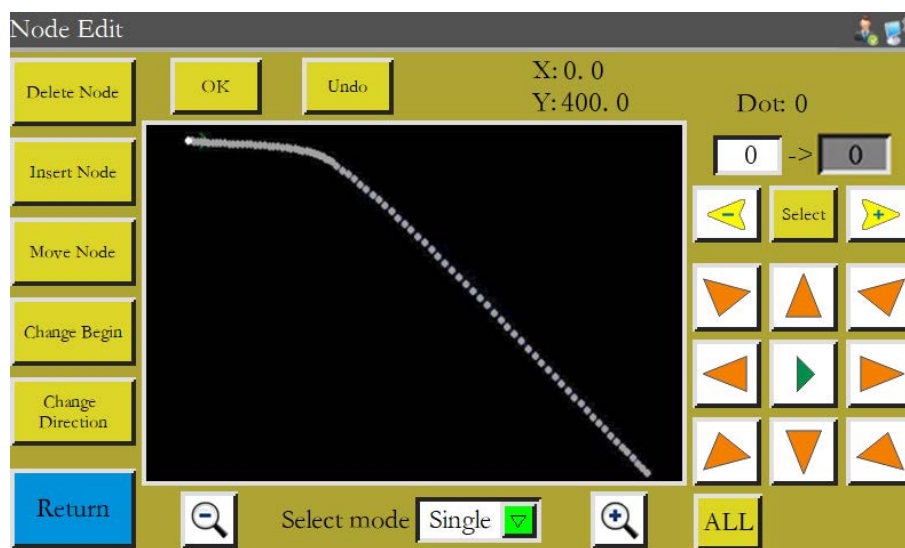

Copy



: Copy the same curve with certain X and Y offset from the original curve.

Graph Switch

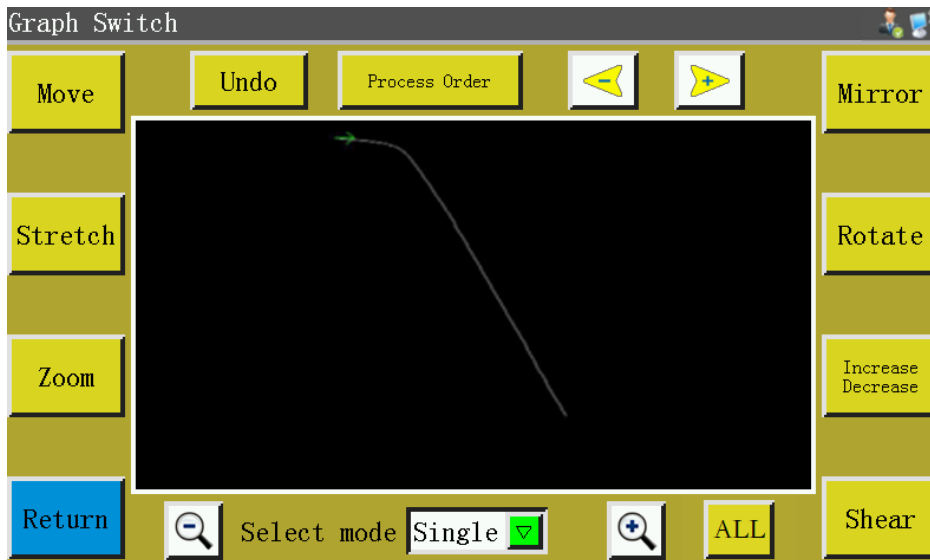
: Graph transformation. Enter the curve transformation interface as follows:



This graph can be changed or edited by setting up parameters such as pan, stretch, scale, rotation, mirroring, increase/decrease, and shear.

Select mode :Select the method and select the curve you want to edit through  .

Undo :Undo the edition of the previous step.

Process Order :Enter the processing sequence interface to view the processing sequence of graph.

Move :Set the position of X and Y of the graph that will be selected for translation, and move the curve to that position. (Note: It can only be seen when zoomed out)

Before translation:



After translation:

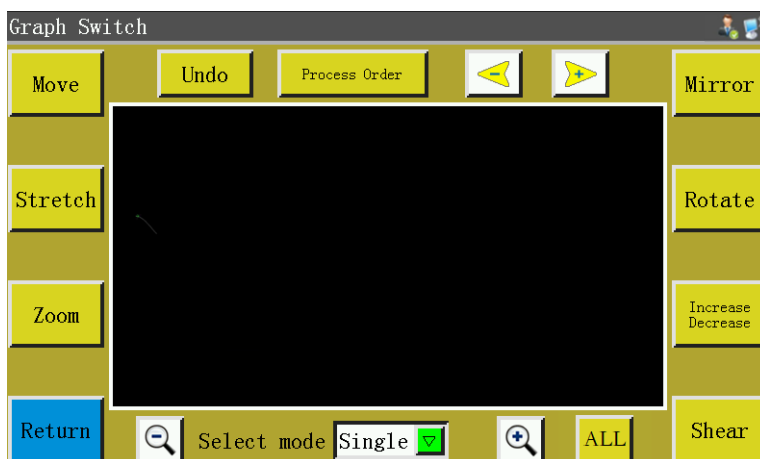

Stretch: Select the graph to be handled, set the horizontal-to-vertical ratio of the curve, and click “OK”, when the graph will be stretched based on the set parameters.

Zoom: The selected graph is scaled by the set graph ratio.

Mirror: Make horizontal and vertical mirroring changes to the selected graph. As follows:

Before the change:

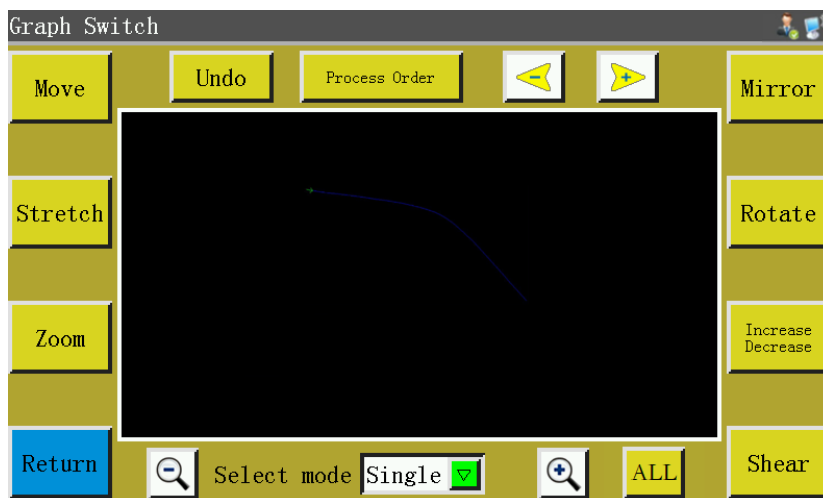

After horizontal mirroring change:

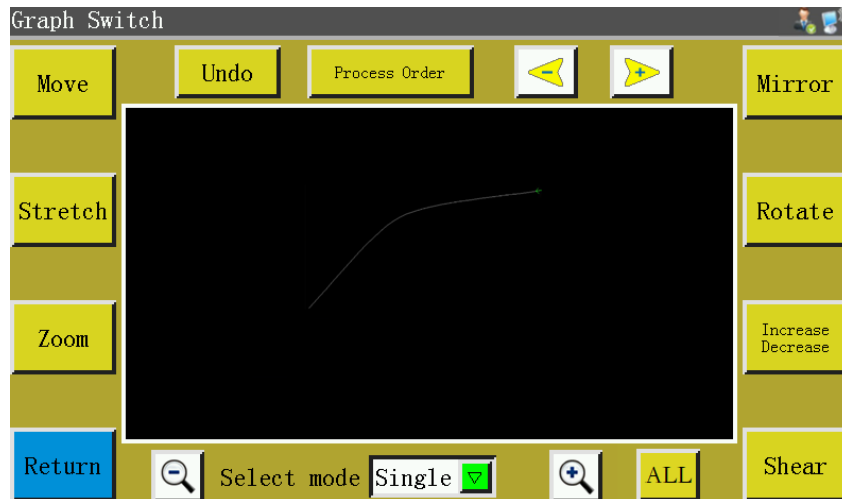

Shear

: Cut the selected graph at a set angle as shown below:

Before cutting:

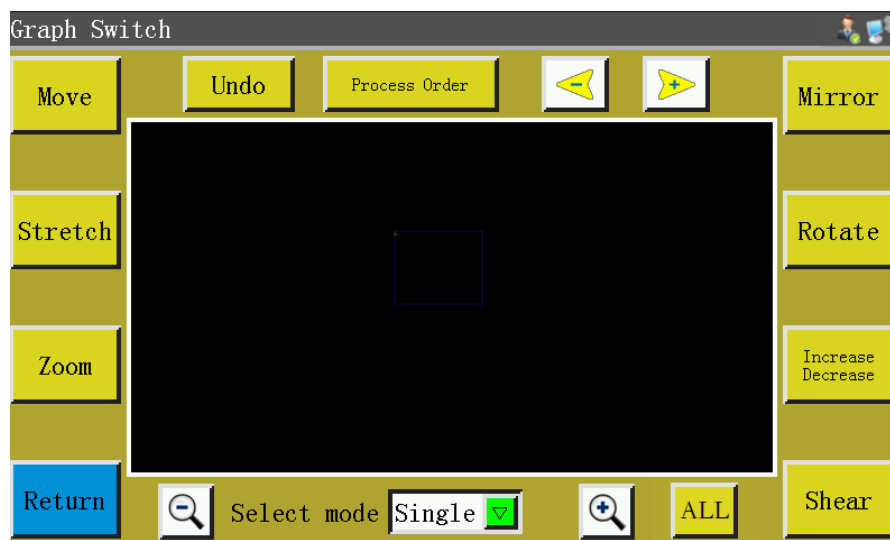

The graph vertically sheared by 5 degrees:

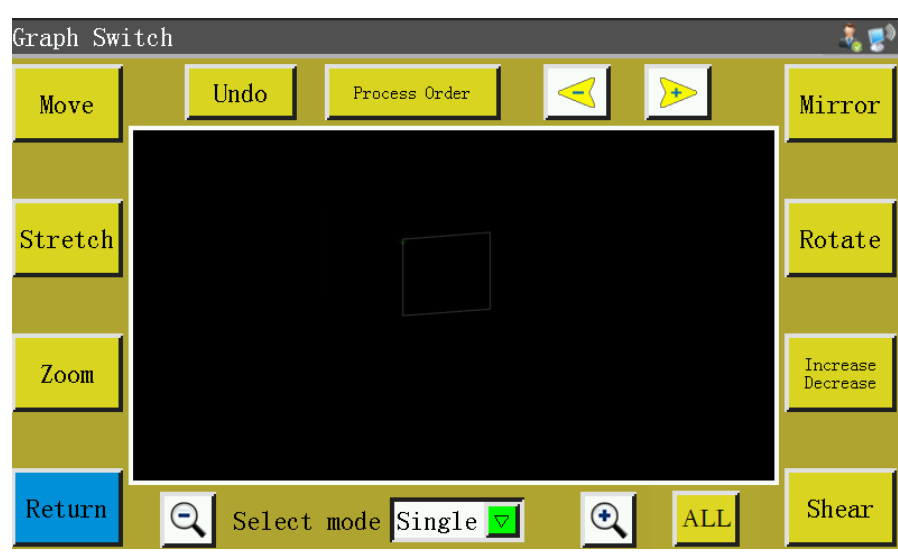

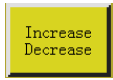

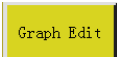

: Choose to increase or decrease the graph by a number of millimeters at the start or end of the selected graph. Refer to  in [2.2.2](#).

Chapter X Parameter File

Parameters may vary depending on usage scenarios. The parameter file management interface is used to import and export parameter files, manage multiple parameter files, and select one of the parameters in memory as the parameter actually used in the system.

Press  key in the main menu interface to enter the memory parameter file interface as shown in the figure:





The interface displays parameters files stored in the system. Click on the file name to make it red, and then click , when a prompt message pops up reading "In progress, please wait..." and then reading "Operation succeeded"; then, the system returns to the main interface, which means the selected parameters have taken effect. All the set values and other hidden parameters in "User parameters" and "Mechanical parameters" will be modified by this parameter file.

The key functions are described as follows:

: Write the selected parameter file into control board as a parameter actually used. The parameter file imported to the system from USB flash disk can't take effect unless "Write" is clicked on.

: Delete one or more selected parameter files.

: Export all the parameters used by the current system to USB flash disk. Click "Export" to enter the new file name, when the specified file name will be generated in USB flash disk with extension .xhp.

: Return to the menu page.





: Return to the main page.



: Copy one or more files from the memory into the root directory of USB flash disk. If a file exists with the same name in the USB flash disk, a message will appear reading “The file already exists, overwrite ?” Make the choice at the end.



: Click to enter the “parameter file in USB flash disk” interface. The system will list the files and folders with extension .xhp, and support multi-level folder operations.

Select the name of the parameter file to be imported into the machine in the USB flash disk parameter file interface, and click  to copy the file to the memory space. Select the file in the way as mentioned above, and click  to make the parameter take effect.

Note: The parameter file varies depending on equipment model. Mixing is prohibited. Even the equipment of the same model may have different optimal factory parameter configurations due to slight differences in their mechanical structures. Hence, it is recommended, after the purchase of machines, to export factory parameters for each machine and save them with different file names for future use.

The detailed steps for exporting parameters:

- a) Insert USB flash disk;
- b) Enter the "Parameter file" interface, and click "Export";
- c) In the pop-up dialog box, enter numbers or letters as the file name of exported parameter, and click OK to save it to the USB flash disk.

Chapter XI User Parameters

User parameters are principally used by users. Parameters are adjusted based on processing requirements so as to realize convenient processing and improve processing efficiency.

11.1 User Parameters Interface

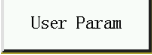
Press  key in main menu interface to enter the user parameters interface as shown in the figure:

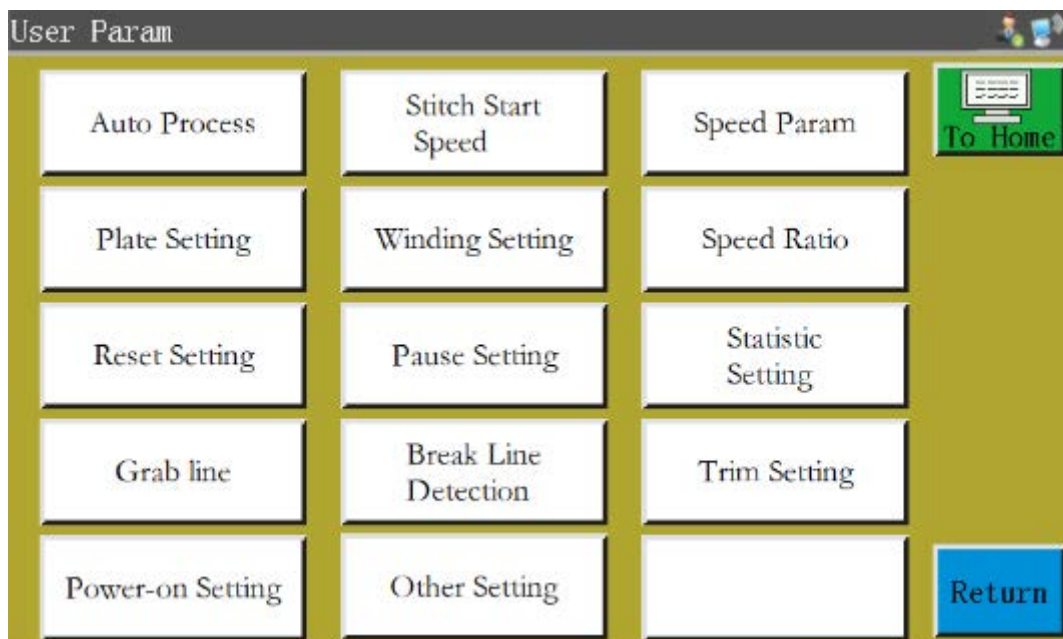

Parameter classification description:

Auto Process: Set the parameters of sheet pressing, thread cutting and foot pressing, etc. during automatic processing.

Stitch Start Speed: Set the start speed of the first stitches, and whether stitching should be started slowly or not.

Speed Para: Set the running speed of spindle and XY axes.

Plate Setting: Set relevant parameters for sheet pressing.

Winding Setting: Set winding parameters.

Speed Ratio: Set the spindle processing speed override.

Reset Setting: Set relevant parameters such as the speed at the time of reset, and whether the pressure plate is put down or not.

Pause Setting: Set the parameters used when pausing.

Statistics setting: Set related parameters of processing statistics.

Grab line: Set the thread trimming and stitching start thread grab position parameters.

Break Line detection: Set relevant parameters for break detection.

Trim Setting: Set relevant parameters for trimming.

Power-on Setting: Set the parameters that need to be initialized when the machine is powered on.

Other Setting: Set parameters relating to cycle processing and interface display.

Take automatic processing as an example, where the interface is as follows:

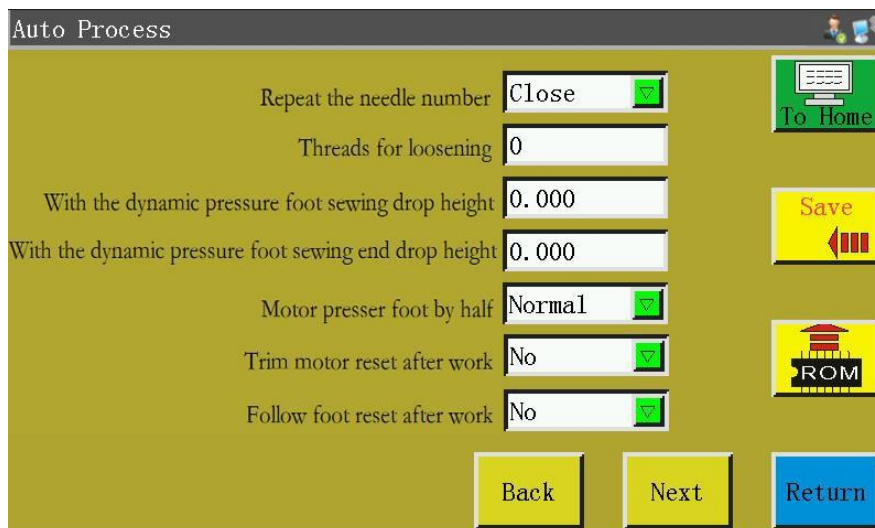
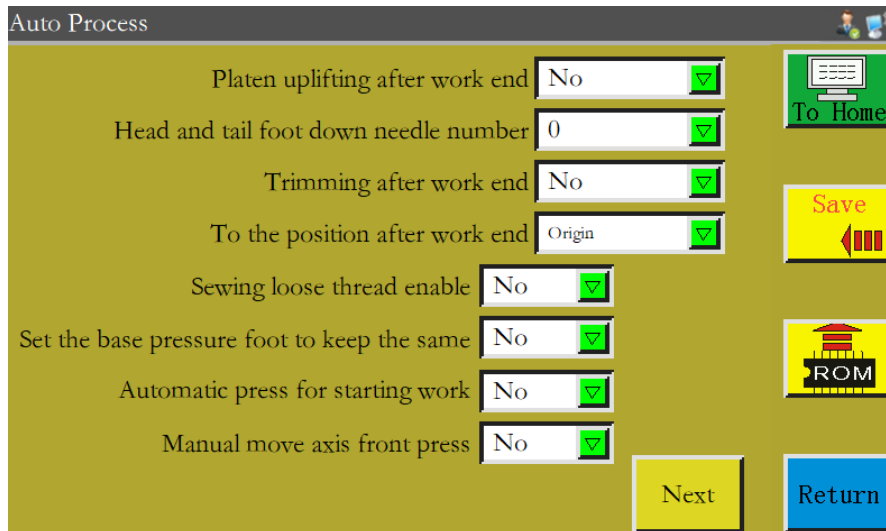

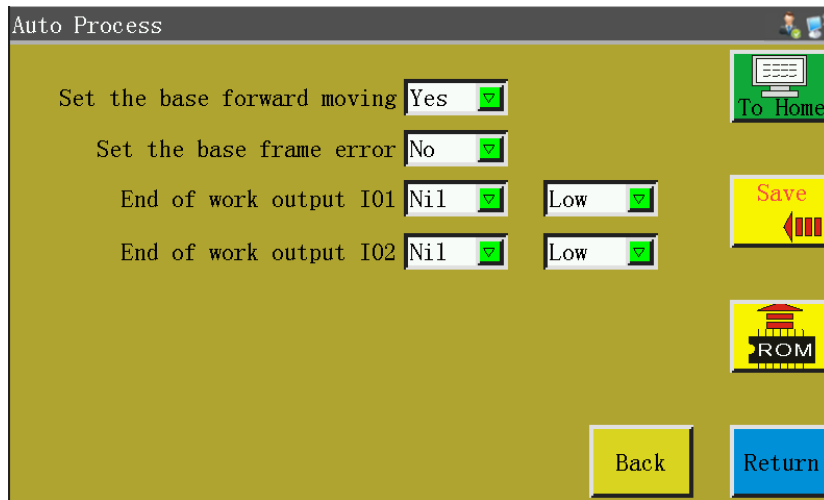



The "Restore" key can be used to restore the pre-modification parameters before the set parameters are saved.

11.2 Introduction to User Setting Parameters

Parameter classification	Parameter name	Range	Default	Parameter meaning and remarks
Auto Process	Platen uplifting after work end	Yes/No	Yes	
Auto Process	Head and tail foot down needle number	0-8	0	
	Trimming after work end	Yes/No	Yes	
	To the position after work end	Origin/Secondary origin	Secondary origin	The "origin" means absolute coordinate origin; "Secondary origin" refers to the secondary origin (offset point) added to the file
	Sewing loose thread enable	Yes/No	No	
	Sewing loose thread enable	Yes/No	No	

	Automatic press for starting work	Yes/No	Yes	
	Manual move axis front press	Yes/No	No	
	Repeat the needle number	Close/1/2/3	Close	"1"/"2" means that when the stitching is started, the first needle position is sewn for 1/2 additional times before the sewing of next needle position. "Close" means the sewing is not repeated.
	Threads for loosening	0~255	0	
	With the dynamic pressure foot sewing drop height	0.000-4.000	0.000	
	With the dynamic pressure foot sewing end drop height	0.000-4.000	0.000	
	Motor presser foot by half	Normal/Halve /Enlarge	Normal	
Auto Process	Trim motor reset after work	Yes/No	Yes	
	Follow foot reset after work	Yes/No	Yes	
	Set the base forward moving	Yes/No	Yes	
	Set the base frame error	Yes/No	Yes	
	End of work output IO1	Nil/ OUT1— OUT12;Low/ High	OUT1;Low	
	End of work output IO2	Nil/ OUT1— OUT12;Low/ High	OUT1;Low	
Stitch	Speed of the first stitches	100-3000	300	(Adjusted as needed)

Start Speed	(rpm)			Acceleration from standstill to maximum sewing speed requires up to 5 stages. Excessively high acceleration may cause the initial stitches to be smaller.
	Speed of the second stitches (rpm)	100-3000	600	
	Speed of the third stitches (rpm)	100-3000	1000	
	Speed of the fourth stitches (rpm)	100-3000	1600	
	Speed of the fifth stitches (rpm)	100-3000	2000	
	Back needle speed (rpm)	100-3000	1500	
	Slow speed start	Yes/No	No	
	Start 2 needle is low speed	Yes/No	No	Slow: Increased at fixed rate; above-noted acceleration settings are invalid
	End 2 needle is low speed	Yes/No	No	
Speed Param	The highest speed of the spindle (rpm)	100-4500	2800	Limit the max. working speed in the main interface of processing.
	Frame moving speed (mm/min)	100~100000	15000	The moving speed of press frame in idling segment during normal sewing operation
Speed Param	Frame inching speed (mm/min)	100-20000	5000	Preview stitching press frame's moving speed when capturing or modifying files
	Simulation speed(mm/min)	100-60000	8000	Moving speed of test sewing track
	Button of speed 1 (mm/min)	100-20000	500	The speed that corresponds to  icon among the 8 direction keys during manual frame shift

				or file capture.
	Button of speed 2 (mm/min)	100-20000	1200	The speed that corresponds to  icon among the 8 direction keys.
	Button of speed 3 (mm/min)	100-20000	2600	The speed that corresponds to  icon among the 8 direction keys.
	Head 2 speed (mm/s)	0.000-2000.000	0.000	XY moving speed of head 2 (e.g., for laser cutting)
	Head 3 speed(mm/s)	0.000-2000.000	0.000	XY moving speed of head 3 (e.g., for laser cutting)
	Continuous inching speed	Reduce/Lowest/Normal	Reduce	
	Rverse speed(rmp)	0--3000	0	Working speed of reverse sewing
	The last few needle speed limit	0--30	0	
	No pull line blowing output IO	OUT1—OUT8/无	无	
	The last needle speed	100--1800	0	
Plate Setting	Prohibit sewing when uplified	Yes/No	Yes	
	The frame must be pressed when moving	Yes/No	Yes	When the frame is lifted, the axis cannot be moved manually.
	Double frame lifting delay(ms)	0--10000	0	Interval time between main and auxiliary frame lifting
	Double frame pressing delay(ms)	0--10000	0	Interval time between main and auxiliary pressure frames when

				they are pressed down
	Pedal operating sequence	Normal/Speci al	Normal	
	Pedal operating mode	1STA/1STB/1 STC/2ST/3ST	2ST	There are different operation modes for pedal switches of different mechanical structures (with or without self-locking, etc.).
	Sewing clip line start angle	1-990	1	
	Sewing clip line end angle	1-990	1	
	Trim clip line start angle	1-990	1	
	Trim clip line end angle	1-990	1	
Winding Setting	Winder machine status	Allow/Prohibi t	Allow	Set the  允许 default state of processing assist interface
	Winding speed	100-4500	1200	Set the default rotation speed for winding in the processing assist interface
	Winding timer (s)	1-63000	70	Set the time from start to automatic stop of winding in processing assist interface
Speed Radio	High speed radio (%)	1-100	100	Actual speed of spindle in main interface = Set speed * High speed override
	Med-high speed radio (%)	1-100	90	
	Med-low speed radio (%)	1-100	70	
	Low speed radio (%)	1-100	60	
Reset Setting	Reset when the clamp down	Yes/No	Yes	
	Manual reset after lifting	Yes/No	Yes	

	clamp			
	Return origin mode	XY /X priority/Y priority	XY	"XY " means to return to the origin simultaneously; : "X priority" means X axis returns to the origin first, and then Y axis returns thereto.
	Back to the origin of speed(mm/min)	100-20000	100	X and Y axes speed when returning to the origin
	XY axis cushion during reset	X Axis/XY Axis/Y Axis/No	X Axis	
	Extension axis reset speed (mm/s)	1.000- 2000.000	1.000	
	Press reset alarm prompt	Yes/No	Yes	
	Output IO before reset	OUT1-- OUT10/Nil	Nil	Output IO
		Low/High	Low	Level
	Output IO after reset	OUT1-- OUT10/Nil	Nil	Output IO
		Low/High	Low	Level
Pause Setting	Trimming threads in pause	Yes/No	Yes	"Yes": Automatic thread trimming. "No": No automatic thread trimming
	Stitches position in pause	Down position/Up position	Up position	
	Uplifting the plate in pause	Yes/No	Yes	
	Pause switch type	Self	Self lock	"Self lock" means the switch

		lock/Ordinary		cannot automatically bounce when depressed; "Ordinary" means the switch can automatically bounce when depressed.
	The foot does not lift when paused	Yes/No	Yes	
Statistic Setting	Bobbin line reset when power on	Yes/No	No	"Yes" means the "used length of bottom thread" is cleared after power-up
	Stopping working after the Bobbin line	Yes/No	Yes	"Yes" means the operation is stopped when the used length of bottom thread reaches the total length
	Effective of the Bobbin line alarm	Yes/No	Yes	"Yes" means automatic statistics of the used length of bottom thread during operation
	Piecework reset when power on	Yes/No	Yes	"Yes" means "current value of count by piece" is zero-cleared after power-up
	To continue after work piece	Yes/No	Yes	"No" means the operation stops when "current value of count by piece" reaches the "total count by piece".
	Effective of the piece alarm settings	Yes/No	Yes	
	Work time statistics	Yes/No	Yes	"Yes" means the processing time

				statistics feature is enabled.
	Bobbin counting mode	IN1—IN7/ Default	Default	Non-default bottom line detection device can select an input IO as the detection trigger signal.
	Bottom line margin adjustment(mm)	0--600000	0	For special bottom line detection device, the error residual length of the bottom line residual length is set.
Grab line	Trim catching position	0.0-200.0	0.0	
	Sewing start catching position	0.0-200.0	0.0	
	Laser output IO	OUT1- OUT12/Nil	Nil	Used to specify the output IO state for a laser line segment.
	Coord position 1--4	0.000— 6000.000	0.000	Used for "self-programming" functional mode, coordinate position of relevant axis-shifting instructions, dynamic modification and invocation.
	Attach param 1--4	0--100000	0	For the "self-programming" functional mode, some instructions need to be set and invoked dynamically.
Break Line Detection	Automatic break detection	Yes/No	Yes	"Yes" means to stop the operation and give a prompt when thread break is detected
	Cutting for the break line	Yes/No	Yes	"Yes" means the thread is automatically cut upon detection of break
	Ignore the pin number when	1-255	3	No break detection is performed

	sewing			for the initial set stitch number
	Check threads of the broken in effect	1-255	2	Thread break is confirmed by continuous detection of break at the set stitch number
	Delay when broken threads (s)	0.01-255.00	0.20	Set the delay time and take actions against break after confirming thread break
	Broken line output IO	OUT1-OUT12/Nil	Nil	After the disconnection occurs, the corresponding output IO maintains a high level output for 1 second.
	QEP2 as bobbin thread detection	Yes/No	No	Some machines employ B encoder for bottom thread detection
Trim Setting	Speed of the spindle trimming (rpm)	10-500	10	
	Starting delay of trimming (s)	0.01-6.55	0.1	
	Duration of drawing threads (s)	0.01-6.55	0.1	
	Dial line of delay presser foot (s)	0.01-6.55	0.1	
	Delay for loosening threads(s)	0.01-6.55	0.01	
	Whether to trim threads after moving empty	Yes/No	Yes	
	Whether to use the pull thread	Yes/No	Yes	"No" means the wiper is turned off
Trim	Motor trim thread mode	Back and	Back and forth	

Setting		forth/single		
	Trim thread travel motor	1.0-100.0	1.0	
	Flat knife grip delay (ms)	1-350	1	
	Back a knife speed ratio	10-100	100	
	Loose line start mode	Angle/Delay	Angle	
	Loose line angle	0-999	850	
	Knife section speed	Yes/No	No	
	The first knife length	0.000- 100.000	0.000	
	The knife first speed(mm/s)	0.000- 100.000	0.000	
	The knife second speed(mm/s)	0.000- 100.000	0.000	
Power-on Settings	Stitches to the up position when powered on	Yes/No	Yes	
	Frame automatic back to the origin	Yes/No	No	
	Motor lock when powered on	Yes/No	Yes	
	Presser foot lift when powered on	Yes/No	Yes	
Other Setting	Air-pressure detection	Yes/No	No	"Yes" means stoping and alarming if the air pressure is low when working.
	Whether to circular processing	Yes/No	No	"Yes" means the same file is processed in a cyclic manner after startup

	Circular work time (min)	1-1440	1440	Total cycle time; cycle processing is stopped when time is up
	Circular work gap(s)	0-20	2	The interval between the completion of processing and the restart of processing during processing cycle
	Work end position	Origin/Right/ Sewing POS/Default	Origin	Origin: The point where the XY axis coordinates are both 0 Right: Rightmost point of the processing range Sewing POS: The first sewing point of processing file Default: Stop after processing
	Template recognition mode	Barcode/RFI D	RFID	File Number: Barcode recognition mode File Name: Electronic tag recognition mode
	Interface style	Classic/ Simplicity	Classic	Classic: Three-dimensional keys Simplicity: Flat keys
	Motion mode before starting work	XY /X priority/Y priority	XY	
	Empty movement mode in working process	XY /X priority/Y priority	XY	
	The needle back	0-160	0	
	Connect extension screen	1/2/No	No	"Yes" means the display screen can be connected to extension

				screen to display working files and other information
	Voice prompt	Middle/High/ Low/Close	Close	
	Enable Blackout Memory	Yes/No	Yes	After restarting the electricity, continue sewing progress before power failure, continue sewing.
	The file is valid when the RFID label leaves	Yes/No	No	

Chapter XII Machine Param

Mechanical parameters can meet the more complex requirements of users. Users can set mechanical motion attributes according to their own needs, but the premise is that it must be operated by mechanical assemblers.

12.1 Machine Param Interface

Press  key in main menu interface to enter the machine param interface as shown in the figure:

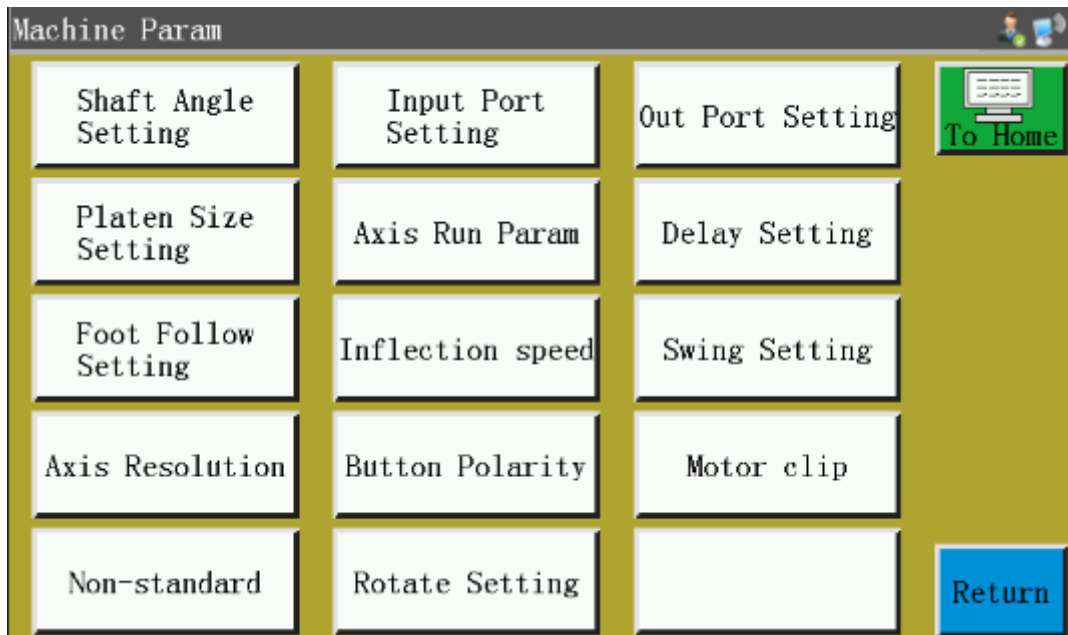

Description of parameter classification:

Shaft Angle Setting: The setting of angle values of feeding, thread cutting and machine needle.

Input Port Setting: Enter IO polarity settings.

Out Port Setting: Setting of duty cycle and duration of output IO.

Platen Size Setting: Size of working breadth and setting of datum-free.

Axis Run Param: Setting of direction and polarity of spindle, XY axis, foot press, etc.

Delay Setting: Settings of delay or time for foot pressing, plate pressing and shutdown.

Foot Follow Setting: Set the working angle and height of the servo foot.

Inflection speed: Set the working speed at inflection point.

Swing Setting: The setting of the stroke of the swing needle rod and the extended shaft.

Axis Resolution: Set the resolution of the XYZ axis.

Button Polarity: XYZ axis key polarity, graphics mirror and spindle oil supply settings.

Motor clip: Set up double motor clamping wire.

Non-standard: Non-standard special purpose related settings.

Rotate Setting: Settings of machine head rotation type.

Taking the setting of shaft angle and pressing plate size as examples, the interface is as follows:

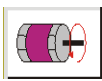

: Spindle inversion key, the key spindle began to invert slowly.

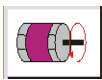

: Spindle forward key, the key spindle began to rotate slowly.



: Manual foot-pressing lifting key, every time a foot-pressing switch between lifting and pressing.



: According to the angle value of the current machine updown needle positioning, other angle values can be calculated automatically according to the proportion of the conventional setting values.



: Needle bar up and down keys, each button once the needle bar up positioning (the highest point of the machine needle) and down positioning (the lowest point of the machine needle) switching.



: Manual line cutting operation.

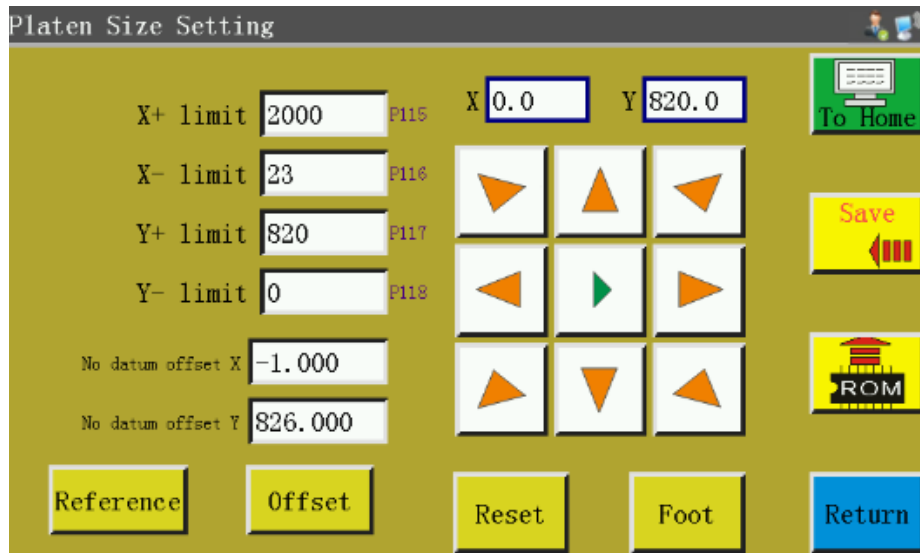

Reference : When adjusting the offset-free reference point, the offset reference point should be set first.

Offset : According to the reference position, the reference-free offset position is automatically calculated and set.

ROM : Restore key, the parameters set can be restored by the restore key before they are saved.

12.2 Introduction to Setting up Mechanical Parameters

Parameter classification	Parameter name	Range	Default	Parameter meaning and remarks
Shaft Angle Setting	Feeding start angle	0-999	0	
	Feeding end angle	0-999	0	
	Trimming start angle	0-999	0	
	Trimming end angle	0-999	0	
	Surface line dial angle	0-999	0	

	Needle up position	0-999	0	
	Needle down position	0-999	0	
	Main axis stop time	0-20	10	Spindle backoff delay 0-20 milliseconds, inversion delay
Input Port Setting	Input 01--07	Open/Closure	Open	Input 10 polarity settings are currently only used for input 03 (pause), other standby.
Out Port Setting	Output duty ratio-Frame	25%; 50%; 75%; 100%	25%	
	Output duty ratio -Foot			
	Output duty ratio -Trim			
	Output duty ratio -Pull			
	Output duty ratio -Loose			
	Output duty ratio -LED			
	Output mode	Ordinary/Program	Ordinary	
	Start to continue(ms)	0-500	0	
	Thread-holding mode	Thread-loose/Thread-holding	Thread-loose	
Platen Size	X+ limit	10-15000	10	Size in Negative Direction of Working Range X
	X- limit	0-15000	0	Size in Negative Direction of Working Range X.

Setting	Y+ limit	10-10000	10	Size in Negative Direction of Working Range Y
	Y- limit	0-10000	0	Size in Negative Direction of Working Range Y.
	No datum offset X	- 5000.000 —	0.000	
	No datum offset Y	5000.000		
Axis Run Param	Spindle motor DIR	Positive/ Negative	Positiv e	
	Spindle encoder			
	X-Axis motor DIR			
	Y-Axis motor DIR			
	X polarity			
	Y polarity			
	Spdrate	ALL; 95%; 90%; 85%; 80%; 75%; 70%	ALL	
	Main motor type	1/2/3	1	
	Foot Travel	0-10000	0	
	Foot resolution	0-60000	0	

	Foot polarity	Positive/ Negative	Positive e	
	Foot Dir polarity	Positive/ Negative	Positive e	
	M	200-500	200	
	N			
	X-Axis rigid	-6---6	0	
	Y-Axis rigid			
Delay Setting	Automatic processing delay (ms)	0-5000	0	
	Foot down lifting delay (ms)			
	Foot uplifting delay (ms)			
	Plate operating delay (ms)			
	Electromagnet foot dormancy time(s) (s)	0--300	0	When the solenoid foot is idle, it will automatically enter the dormant state after exceeding the set time (corresponding to the low level of IO output) and turn off this function when the value is 0.
	Timeout stop time(ms)	0-- 1800000	0	After the last work, if the work does not continue beyond the set time, the alarm will be prompted. Turn off this function when the value is 0.
	Work enable input IO	0--7	0	If the input IO is set at high level, it can work normally. Otherwise, it can not start or stop working. Turn this off when the value is 0.

	Start input detection			Only when the input IO is set at high level can the work be started. Turn this off when the value is 0.
Foot Follow Setting	Rise start angle	5-995	10	
	Rise end angle			
	Drop start angle			
	Drop end angle			
	Foot follow height(mm)	0.200- 100.000	0.026	
	Y-Axis rise start angle reply	- 300~ 300	0	
	Y-Axis rise end angle reply			
	Y-Axis drop start angle reply			
	Y-Axis drop end angle reply			
	The descent start angle can be set to a limited extent.	Yes/No	No	
Inflection speed	Inflection slow speed	Yes/No	Yes	
	Inflection speed	10--5000	0	
	Speed of the first inflection	10-5000	1200	
	Speed of the second inflection		1300	

	Speed of the third inflection		1400	
	Speed of the forth inflection		1500	
	Speed of the fifth inflection		1600	
Swing Setting	Swing start angle	0-999	0	
	Return start angle	0-999	0	
	Swing distance	0.00-360.00	0.00	
	Swing needle bar X polarity	正/反	正	
	Swing needle bar Y polarity			
	Axis 2 maximum travel(mm)	0.000-10000.000	0.000	
	Axis 3 maximum travel(mm)			
	Add a special needle at the end of sewing(mm)	0.0-1.0	0.0	At the end of sewing, sew one more stitch.
Axis Resolution	Realiti length	1.0--99999.9	1.0	Distance from the actual movement of the corresponding axis
	Theory length			The distance that the corresponding axis should theoretically move
	X Axis resolution	1.0000000	1.0000	According to the actual and theoretical input length values, the resolution can be calculated automatically by pressing  keys.
	Y Axis resolution	-	000	

	Z Axis resolution	200.00000 00		
	X Axis position	0.000—	0.000	Current absolute coordinate position of X-axis
	Y Axis position	10000.000		Current absolute coordinate position of Y-axis
Button Polarity	Button X polarity	Positive/ Negative	Positive	
	Button Y polarity			
	Button Z polarity			
	Graphic X direction mirror	Yes/No	No	X-Direction Mirror Display When Displaying Graphics
	Graphic Y direction mirror			Y-Direction Mirror Display When Displaying Graphics
	Main axis number of oil supply	100- 90000000	100	After how many turns of the spindle are rotated, the oil supply operation is performed. That is, the corresponding output IO is high level.
	Oil supply duration(s)	0.00- 650.00	0.00	The duration of oil supply to the spindle is the time when the output IO maintains a high level.
Motor clip	Clip zero 1	0.000-	0.000	
	Clip zero 2	100.000		
	Clip line 1 maximum travel	1.000—	1.000	
	Clip line 2 maximum travel	100.000		
Non-standard	Head 3 mode	Ordinary/ Punching	Ordinary	Change the use of Head 3, generally for laser cutting.
	Output IO	OUT1— OUT6/Nil	Nil	When the first three modes are the punching modes, they are effective and correspond to the output IO of the punching device.

	Input IO			When the head 3 modes are punching modes, the parameters are valid, and the IO of the input detection of the punching device corresponds to the IO of the punching device.
	Delay (ms)	0.000- 100.000	0.000	When the head 3 modes are punching modes, the delay time is the interval between "output IO" and "input IO".
	Start the output IO ahead of time(mm)	0.000- 8.000	0.000	The parameter "head 3 mode" is valid when the punching mode is used. Before reaching the punching position, the "output IO" is turned on as many distances as possible in advance.
	Length of punching bottom feed(mm)	0.000- 50.000	0.000	The head 3 mode is effective when the punching mode is used, and the length of the punching base material is currently used.
	Total length of punching bottoms	0.000- 2000000.0 00	0.000	When the head 3 mode is the punching mode, it is effective, and the total length of the punching base material.
	The Z axis is used as a shift line	Yes/No	Yes	Special settings for sewing electric blankets
	Shift line position	0.000- 80.000	0.000	The parameter "Z axis is used as cycloid" is valid when it is opened, and the magnitude of the cycloid's oscillation is large.
	Right angle compensation length X(mm)	0.00-1.50	0.00	When the inflection point is right angle, the inflection point moves along the length of X direction.
	Right angle compensation length Y(mm)			When the inflection point is right angle, the inflection point moves along the length of Y direction.
	Frame to Other	Yes/No	No	The head 3 mode is effective when the parameter is punching mode, and the "pressing frame" operation of the main page is automatically changed to

				manual "punching" operation.
Rotate Setting	Rotate along the graph	Yes/No	No	Automatically insert the instruction "rotate along the graphic track" and rotate when sewing.
	Rotary up and down IO	OUT1— OUT12/ Nil	Nil	Control the output IO of the rotating nose when rise or fall.
	Rotary up and down delay	0.0-3000.0	0.0	The duration of IO high level used for "spinning up and down IO".
	Rising and falling only at the beginning and at the end	Yes/No	No	The lifting action is performed only at the beginning and end of the work.
	Rotation offset initial angle	0--360	0	Rotation-assisted migration starting angle.
	Rotation offset radius(mm)	0.000— 0.500	0.000	Rotation-assisted migration radius.

Chapter XIII Assist Setting

Auxiliary settings are used to test hardware input & output, network, time and system upgrade, etc.

13.1 Assist Setting Interface

Press  key in main menu interface to enter the assist operation interface as shown in the figure:

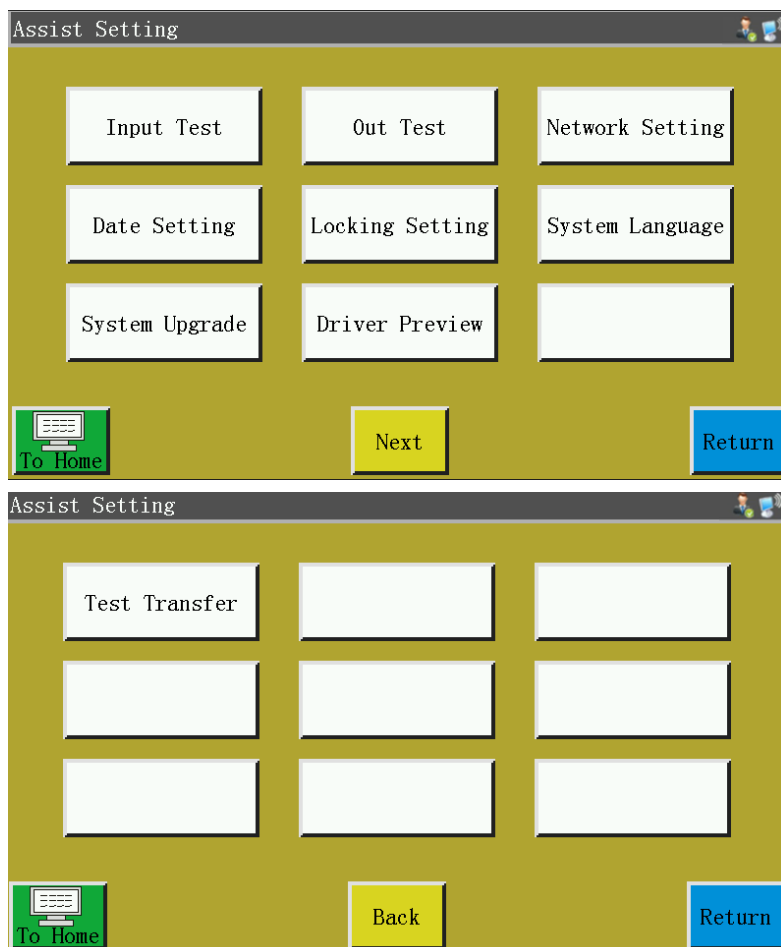

The key functions are described as follows:

Input Test: Test if input port is normal.

Out Test: Test if output port is normal.

Network Setting: Set up wireless network and remote control, etc.

Date Setting: Set the system time.

Locking Setting: Set the administration password, use restrictions, staged unlocking and so on.

System Language: Set the system language of screen. There are three languages, i.e. Simplified

Chinese, Traditional Chinese, and English to be chosen from.

System Upgrade: Used to upgrade the firmware version of motherboard and display screen.

Drive Preview: Preview current, subdivision and other parameters of drive for each shaft.

(Modification is not available on screen)

Test Transfer: Used to test whether the communication between display screen and motherboard, and to view logs, etc.

13.2 Input Test

Used to test if the external input circuit is in good condition.

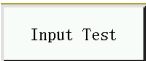
Press  key in the assist operation interface to enter the input test interface as shown in the figure:

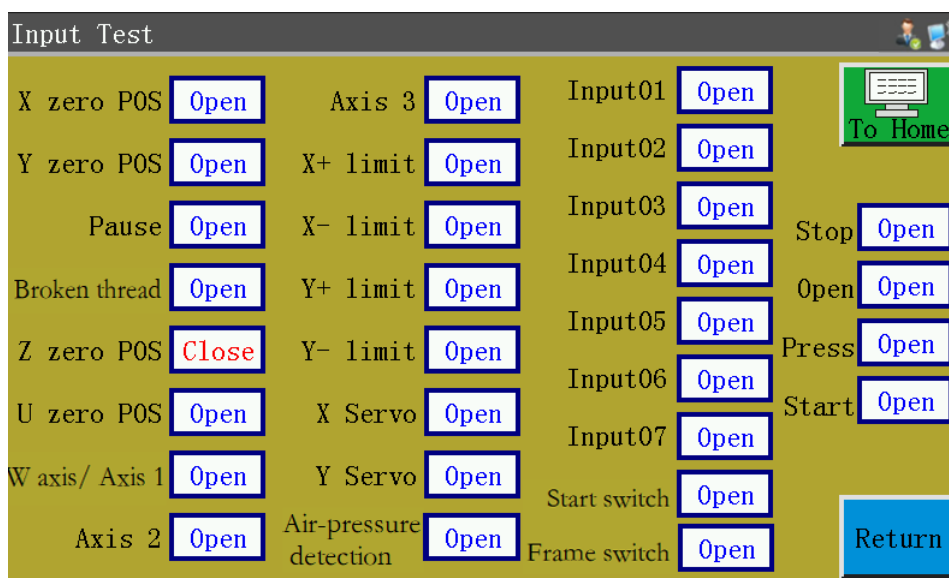

You can manually trigger relevant sensors and check whether the input status has changed, and determine if the sensor or hardware is in good condition.

13.3 Output Test

Used to test whether output control is in good condition.

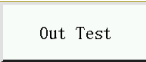
Press  key in assist operation interface to get into output test interface as shown in the figure:

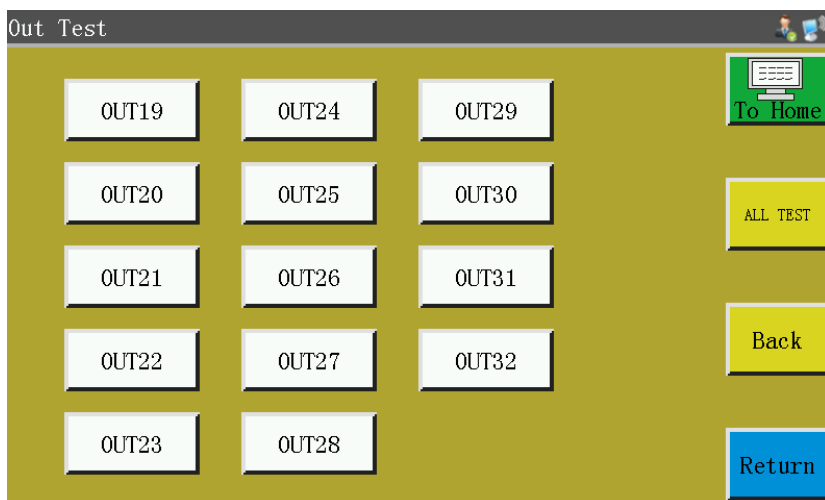
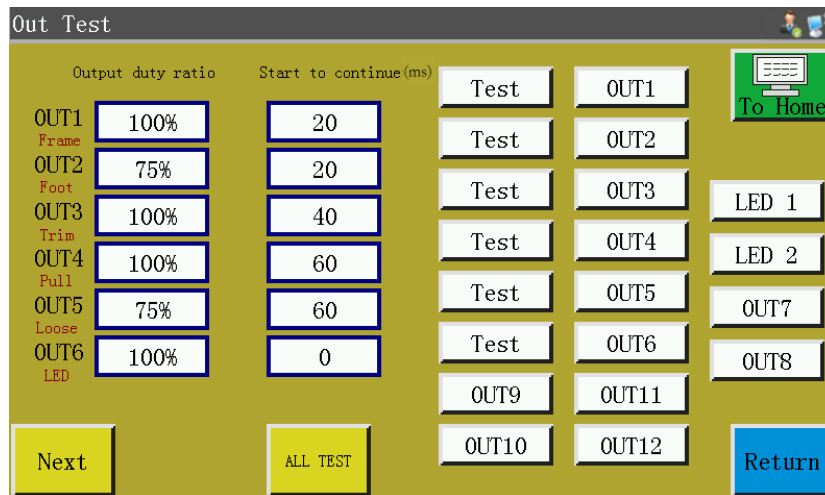

Test the corresponding output as needed.

For trimming, wiping and relaxation electromagnet outputs, one click corresponds to an on/off cycle of equipment electromagnet; if the key is held, ON state will continue. Holding the key too long may result in overheating induced damage to electromagnet.

For solenoid valve outputs such as press frame and press foot, one click corresponds to one motion cycle of cylinder, and another click will return the cylinder to its initial state.

The OUT1, OUT2... function depends on specific device load, and some outputs are not used.

Lamps 1 and 2 are used to control "SYS" indicator lamp ON/OFF on screen, and correspond to red and blue lamps, respectively.

When **ALL TEST** is clicked, it shows the message reading "In progress, please wait...", which indicates a full output test is being performed; the prompt box will not be closed until the test is completed.

13.4 Network Settings

Used to set up wireless network connection.

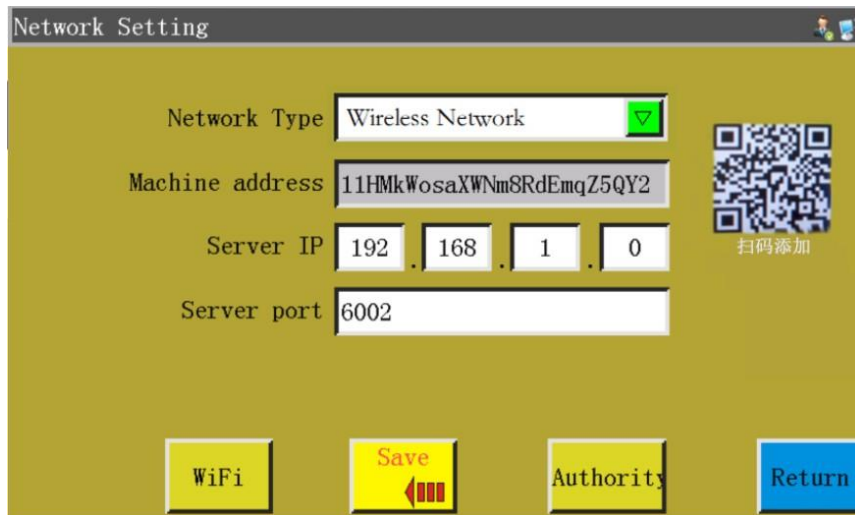

Press **Network Setting** key in assist operation interface to enter the network setup interface as shown in the figure:



Device address: Show the unique address code of current device. The companion APP "Xing Huo IoT" can be used to scan the QR code address of this interface to add the device to the APP for device management.

Server IP: Used to connect a server with a specified IP in LAN to perform LAN control & management. If one of the four input boxes is blank or 0, it means that an external cloud server is automatically connected.

Server port: Used to connect a server with designated IP and port on LAN. If the port is 0 or null, it means an external cloud server is connected.

WiFi: Click to enter the wireless network setup interface and automatically search for hotspots available for current location as shown in the figure below. Click **Refresh**, when WIFI hotspot is searched for again. The number at upper right corner of each hotspot indicates signal strength; the larger the number, the better the signal. Click on hotspot name and enter the password to connect the hotspot. Once the connection is established, the IP address obtained by the current device will be displayed. In the meantime, the   in upper right corner of the screen indicates the established connection with wireless network and server.

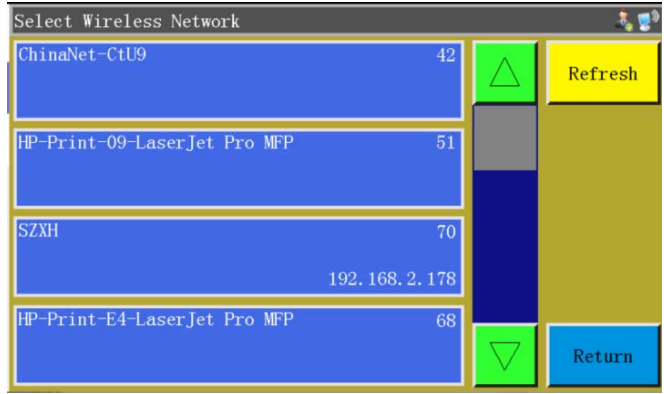

Authority: Click to enter the permission management interface. It is possible to add or delete the mobile login account of APP "Xing Huo IoT", and to set each account for accessing part or all of the dozens of functions of the device.

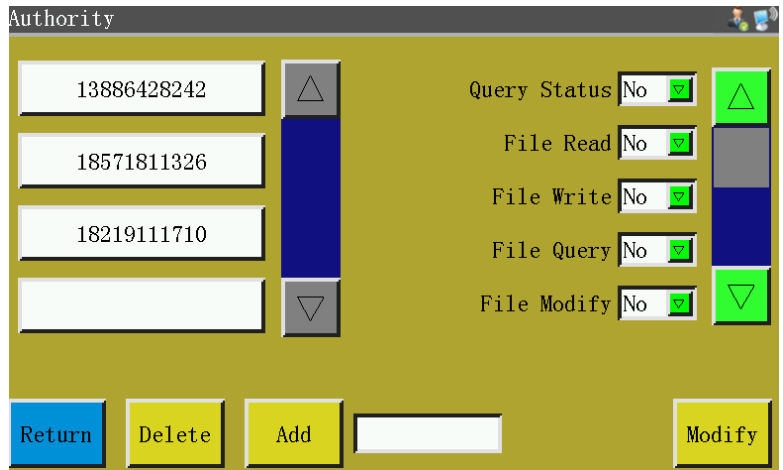

13.5 Date Settings

Used to set the system time (e.g., "year, month, day, hour, and minute") displayed in the upper right corner of the screen.

Enter the administration password to get into the setup interface. The interface is as follows:



The time is displayed in a 24-hour system accurate to "second".



: "Save" button, Click this key to save the set date and time. If the motherboard is equipped with a battery, the time is updated at next startup even if the power was turned off so as to ensure accurate time.

Accurate time helps sewing better, and enables the accurate recording of the time of problem in alarm log, thereby facilitating troubleshooting and problem analysis.

13.6 Lock Settings

Press  key and enter the administration password in the assist operation interface to enter the lock setup interface as shown in the figure:

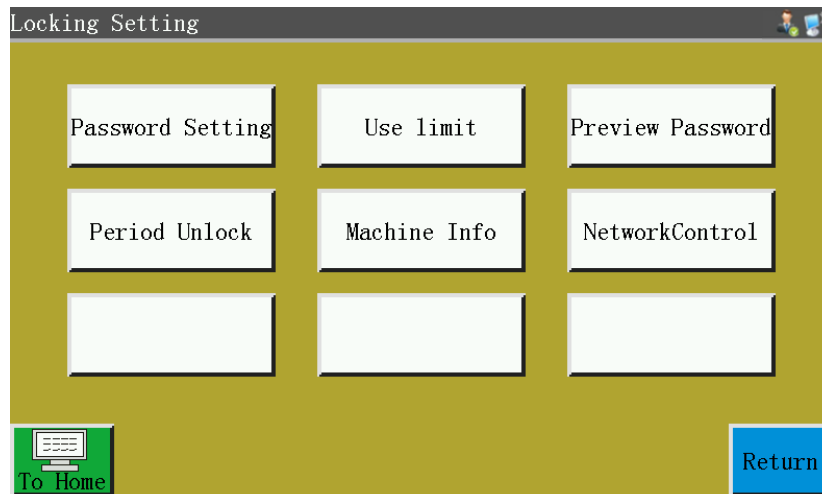

Note: The electric control is designed with four types of passwords, of which the functions are defined as follows:

Administration password: Enabled in "Locking Setting" - "Use limit". Administration password is the password with the highest privilege. You can change other passwords if you know the administration password.

Mechanical parameter password: Enabled in " Locking Setting " - "Password Setting". Once the mechanical parameter password is set up, it's impossible to enter the "Machine Param" setup interface without entering the correct password.

User parameter password: Enabled in " Locking Setting " - " Password Setting ". Once the user parameter password is set up, it's impossible to enter the "user parameter" setup interface without entering the correct password.

Other passwords: Enabled in " Locking Setting " - " Password Setting ". The settings can be

established using upper computer parameters software. You have to enter "other passwords" in order to use file management, lock files, adjust the spindle speed in main interface, and delete processing statistics information.

Period Unlock: When the stage locking machine is effective, the stage locking machine can be unlocked ahead of time.

NetworkControl: View or set the current device network control status, when opened, it means accepting to control whether or not the machine is locked through a specific network mode.

Lock machine setup interface is used to set whether to lock the machine at a fixed time, manage lock secret code and other related operations. It can realize time-limited use such as installment function.

If the equipment is limited, when the set time is reached, the main processing interface will pop up a dialog box prompting the input of a specific unlock password to unlock the lock.

Note: This function is only for manufacturer instead of customers. Improper use of this feature may cause the machine to be locked up.

13.7 System Language

Set the system language of screen. There are six languages, i.e. Simplified Chinese, Traditional Chinese, English, Vietnamese, Japanese and Korean to be chosen. The interface is as follows:



Click on the desired language, when a pop-up window reading "Prompt: Sure do it?" appears. Select "Yes", and the language used in the screen will be changed to the set language.

13.8 System Upgrade

Press  key in assist operation interface to enter the system upgrade interface as shown in the figure:

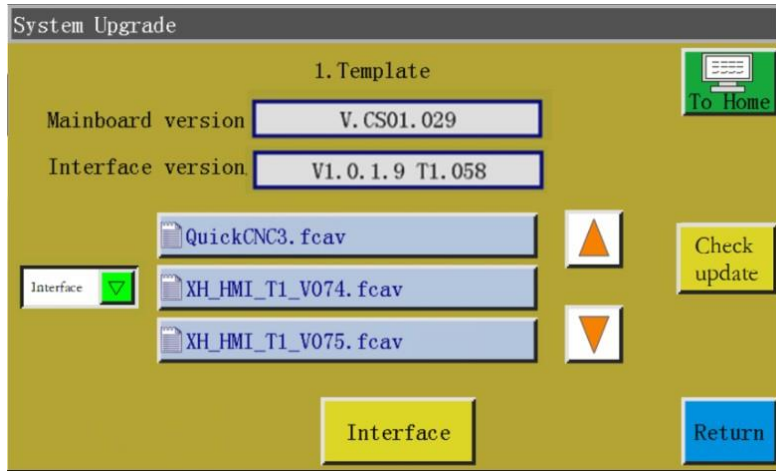

 : Show current motherboard version information.

"CS01" represents the type of system, and remains unchanged after upgrade; "029" represents the branch version number that can be changed through upgrade: It can be upgraded to a higher version or fall back to a lower version.

 : Display the current screen interface version

information. "058" indicates the branch version number

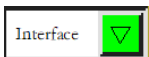

: Click to select the mainboard and display

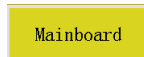

Mainboard

. If you select the interface,

display



Interface

. If you select the instruction, display

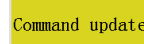

Command update

. Select the file and click the button to upgrade.

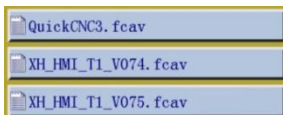



: Upgrade package directory that is automatically read after the insertion

of USB flash disk; display the interface or motherboard upgrade files under all folders and current directory.

The system upgrade steps in the figure are as follows:

- 1) Receive the corresponding upgrade file from the supplier. The extension of interface upgrade file is .fcav (e.g. XH_HMI_T1_V074.fcav), and that of motherboard upgrade file is .TFL (e.g., TZD_CS01.TFL). Put the file(s) in USB flash disk.

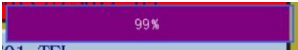
- 2) Insert the USB flash disk and enter the "System upgrade" page.
- 3) Select the desired type of upgrade: Mainboard ,Command or interface.
- 4) Find the upgrade file and select the file to be upgraded.
- 5) Click  ,  or .
- 6) **The prompt message reading "In the upgrade, do not power off!" pops up. Do not turn off the power until this prompt disappears; otherwise, you may need to return the product to its manufacturer for repair.**
- 7) In the case of motherboard upgrade, a progress bar  will pop up to show the progress of the upgrade. It takes about 10 seconds to reach 99%. Wait for about half a minute, the motherboard will be restarted, and the buzzer will ring once to indicate successful upgrade. In the case of interface upgrade, no progress bar will appear. In about half a minute, the display screen will be restarted to indicate successful upgrade.

Description of related error prompts:

(1) Upgrade interface prompt: "Error in upgrade file type"

Cause: a. The upgrade file is not selected; b. The upgrade file is corrupted or not suitable for the present system.

Solution: Reinsert the USB flash disk or put the correct upgrade file therein.

(2) For the upgrade of motherboard, the prompt message reading "No valid upgrade file found" appears.

Cause: No upgrade file is selected

Solution: Insert the USB flash disk, select a valid upgrade file, and click "Upgrade".

(3) For the upgrade of motherland, a prompt message reading "Wrong upgrade file" appears

Cause: The upgrade file is corrupted or not suitable for the present system

Solution: Use the upgrade file of which the type is the same as current system type; for example, CS01 can only use the CS01 upgrade file. Check whether the upgrade file in USB flash disk is correct.

(4) The progress bar remains at 1% after "Motherboard upgrade" is clicked.

Cause: The communication between screen and motherboard is abnormal

Solution: Check whether the connection wire between screen and electric control is in good condition, and restart. If the problem remains unsolved, the product should be returned to its manufacturer for troubleshooting.

13.9 Driver Preview

Display detailed parameters for each shaft of the system drive. The drive preview interface is as follows.

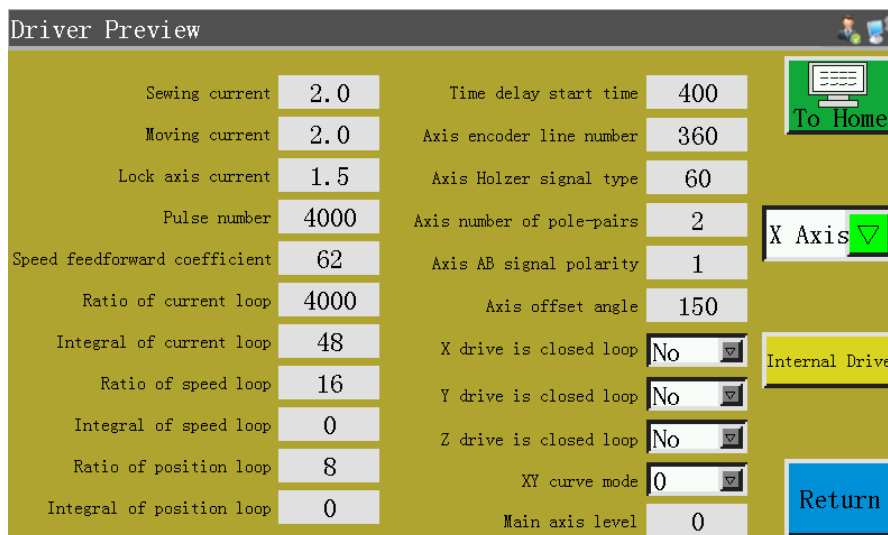

Selection box: Select the drive parameter information to be viewed. (The parameters can't be modified on the screen)

13.10 Test Transfer

Used to test whether the communication between screen and motherboard is in good condition. The test transmission interface is as follows:

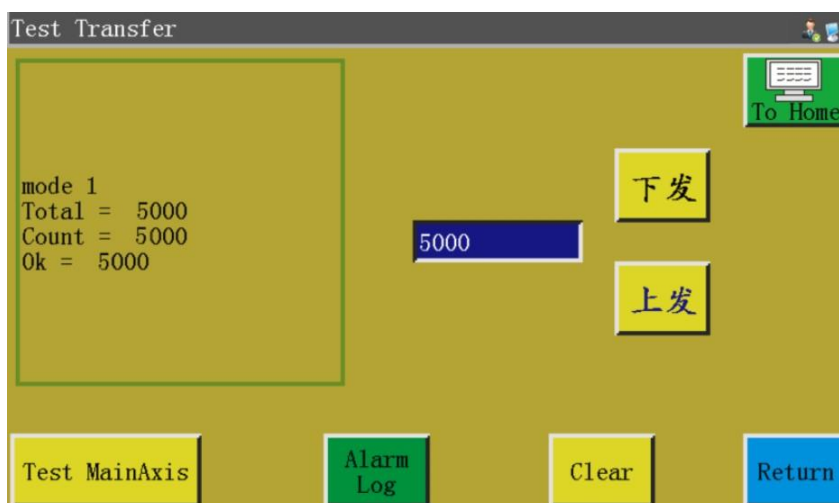

Enter the value you want to test in , and click or , when the test result

will appear on the left window. If the values of Total, Count, and Ok are the same or very close to each other (within a difference of 1%), it means the communication between screen and motherboard is normal.

Clear : Clear the test result on the left.

Test MainAxis : Click this key once, the running current of spindle will decrease, and the normal current can't be restored until the power is turned off and restarted. Used to test whether the spindle can function properly under no load.

Alarm Log : The alarm log can be viewed.

The alarm log interface is as follows:

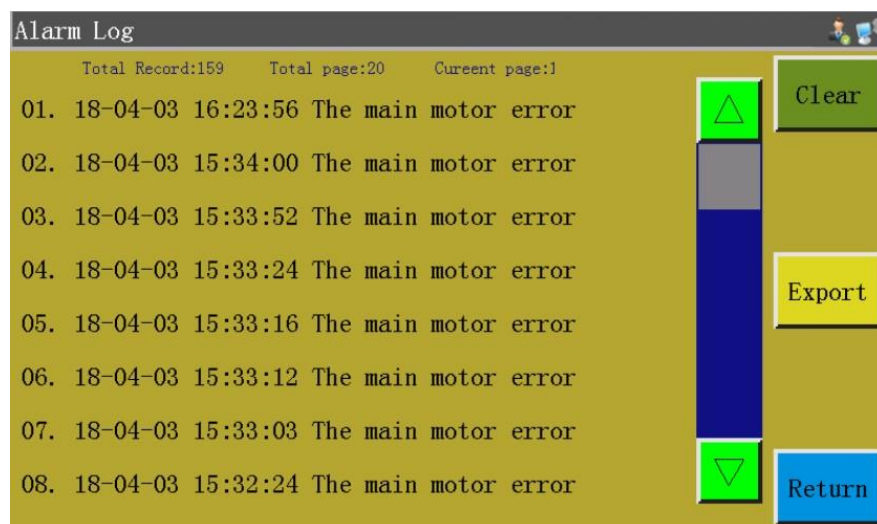

Export :Export the alarm log as a file to a USB flash disk for convenient troubleshooting and anomaly statistics.

Clear : Clear all contents of alarm log.

Chapter XIV Machine State

When an operator finds any anomaly in equipment, the abnormal status of equipment can be reported to the LAN server through local area network to prompt technicians to perform maintenance; moreover, the current equipment status is displayed on the console in real time.

The machine status interface is as follows:

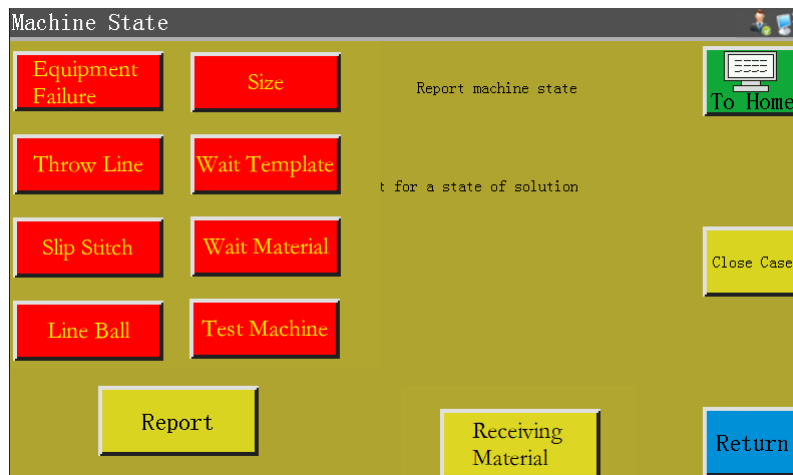

The operator shall select the machine status to be reported, and click **Report** to bring up the following interface:



Upon the arrival of technician at the equipment, he/she can click **In Place**, when the machine status displayed on console reads "Waiting for solution". When **Close Case** is clicked after the removal of anomaly, the machine status displayed on console returns to normal.

Chapter XV Maintenance

To maximize the service life of the sewing machine, please implement maintenances as follows.

15.1. Cleaning

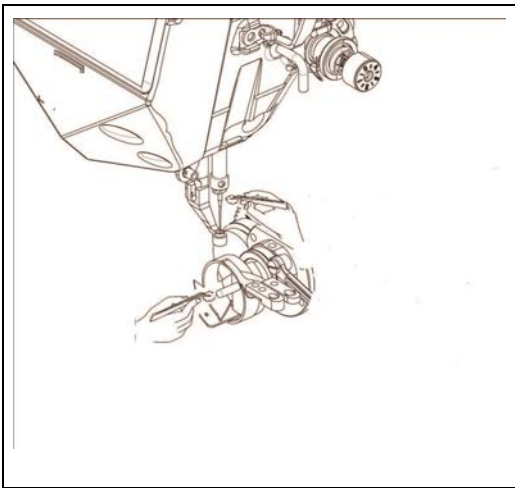

1) Regularly clean fabric clippings and dusts around thread channels and shuttle race.

15.2. Draining waste oil

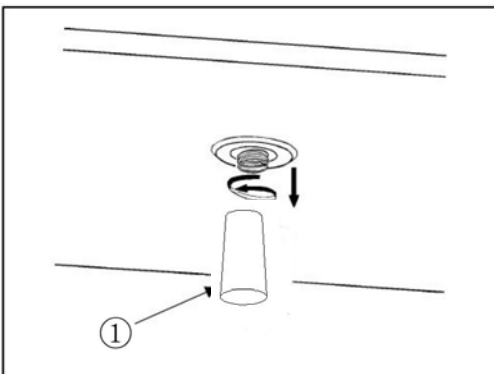

1) When 80% capacity of the oil bottle ① is filled with oil, please drain the waste oil.

15.3. Application of lubricating grease onto metal parts under needle bar and those of presser bar



Warning:

In order to prevent the personal injuries caused by accidental start-up, please turn off the power and make sure the motor stops before operating.

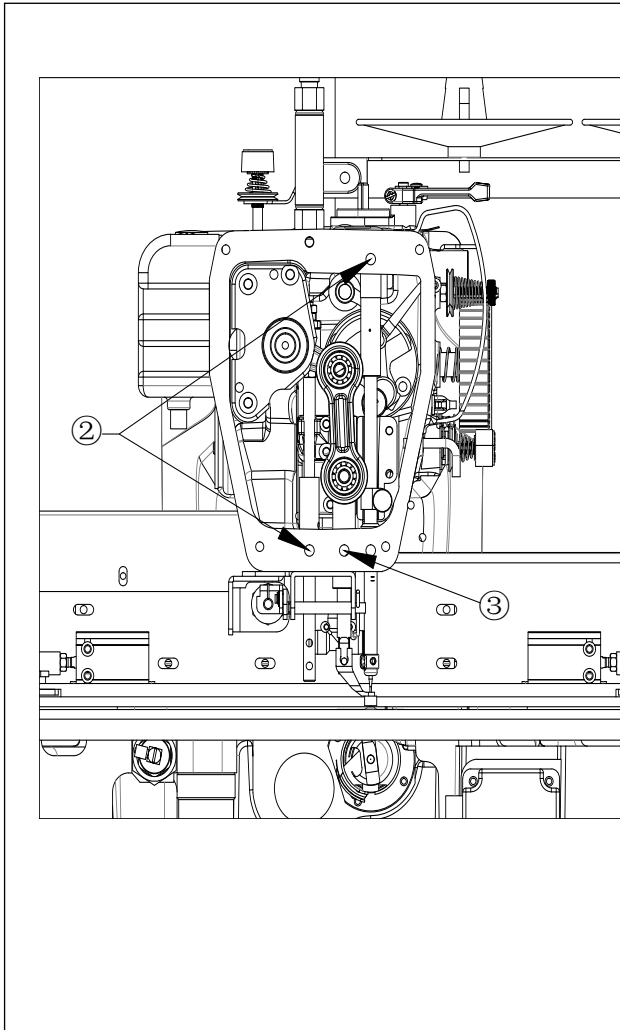

Don't make such operations when needle bar is installed or under other similar states.

- 1) Remove the face plate.
- 2) Remove the screw ② for applying lubricating grease onto the metal parts of presser bar and that ③ for applying lubricating grease onto the metal parts under needle bar (only applicable to DDL-9000C-FMS).
- 3) Remove the cover of the special lubricating grease ①, and then have the front end inserted into the oil filler for the supplement of special lubricating oil ①. At this time, please keep adding the lubricating oil until the oil spills from the oil filler.
- 4) Press the spilled lubricating oil into the oil tank by using oiling screw.
- 5) Please clean the spilled lubricating oil (around the oiling screw).

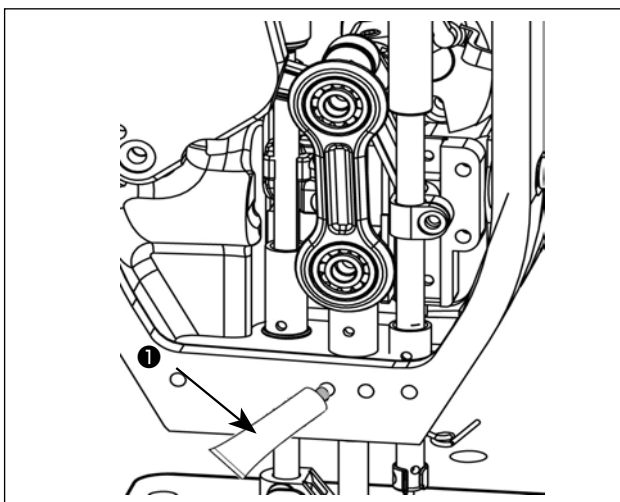

Appendix I: Information Prompt and Solutions

1. “Pressure box didn’t put down”

Cause: The press frame was not dropped before resetting, processing, file capture and file modification

Solution: Click  to drop the frame.

2. “These is no reset”

Solution: Click .

3. “X-axis drive open circuit”

Cause: a. X-axis motor is not connected
b. Loose motor interface

Solution: Turn off the power and check the motor line for connection anomaly.

4. “The bottom thread has been used up”

Cause: The bottom thread required by pre-processed file is longer than the remaining bottom thread (total length of processing statistics interface - initial length of bottom thread)

Solution: a. Use the bottom thread statistics function to replace the bottom thread and modify relevant length information;

b. Where the bottom thread statistics function is not used, you can click  to disable it. See Section 2.2.5 and "User Settings".

5. “The quantity of work is full”

Cause: In the processing statistics interface, the "current value of count by piece" increases to the "total count by piece”

Solution: a. If the processing statistics function is used, it's necessary to modify the "current value of count by piece" or the "total count by piece" so that the former is less than the latter.

b. Where the processing statistics function is not used, you can click  to disable it directly. See Section 2.2.5 and "User Settings".

6. “File range out of bounds”

Cause: a. The length and width of the processing file are beyond the processing range
b. The length and width of the processing file is within the processing range, but the

absolute coordinates are beyond the processing range (if imported first into a machine with large processing range, the file will incorporate absolute coordinates and then be exported to a machine with small processing range)

Solution: a. Reduce the size of processing file
b. Import the processing file generated directly through upper computer. See Section 2.2.4.

7. "Opening state"

Cause: The touch key on top panel is pressed, thus the top panel being open.

Solution: Click the "top panel" key on touch key pad.

8. "No working file"

Cause: The lock file is open.

Solution: Check whether the graphic interface indicates a lock file flag. If so, just click .

9. "The main motor error"

Cause: a. The spindle motor circuit is open or the encoder cable is not connected.
b. Spindle motor is damaged

Solution: a. Check if the motor cables are properly connected, and if the encoder cable is connected.
b. If the motor cables are properly connected, it's necessary to replace spindle motor, test the spindle with  in powered-on state, or manually rotate the motor to check if QEP changes on the screen.

10. "Connecting the main control board"

Cause: a: The connection between motherboard and screen is out of order
b: The screen goes wrong
c: The motherboard is damaged

Solution: a. Check whether both ends of cable are properly connected, restart, and replace screen cable.
b: Replace the screen to check if it functions properly
c: Change motherboard to check if the screen gives a similar alarm.

11. "Couldn't find X zero signal"

- Cause:
- a. X motor direction error;
 - b. X motor position sensor failure;
 - c. Failure to move due to excessively large load in X direction of motor

- Solution:
- a. Enter the manual frame shift interface and test X motor rotation;
 - b. Enter the "input test" interface, and manually trigger the position input signal to check if it can be detected
 - c. Turn off the power and manually push press frame to check if the load is too large and gets stuck.

12. "Motor scissors are not in place"

- Cause:
- a. The encoder cable of motor with Z signal malfunctions
 - b. Parameter setting error

- Solution:
- a. Press  and check if the motor is properly connected or if the motor is in good condition.
 - b. Rotate the motor manually to check whether the W axis/axis limit signal indicator of motherboard changes.
 - c. Check if the parameter settings exhibit conflict.

13. "The main motor direction error"

- Cause: Spindle rotation direction is wrong

- Solution: Use parameter modification software to correct the spindle moving direction or modify the spindle motor direction or spindle encoder direction in shaft operation mode in mechanical parameters.

14. "X-axis driver hardware over-current"

- Cause:
- a: Poor contact of X-axis motor base
 - b: Damaged X-axis stepping motor or short circuit of motor cable
 - c: Motherboard hardware problem

- Solution:
- a: Confirm that the flashing mode of X stepping motor alarm indicator on motherboard is "1 green and 5 red's"; if not, it means false alarm.
 - b: Reinsert X motor cable and restart the machine

c: Change X axis motor

d: Change the motherboard

15. "Motor foot in fault"

Cause: No motor limit signal is detected when motor press foot is reset

Solution: Check motor press foot related base for looseness; check whether the z signal limit signal input changes in the input test interface;

16. "Head board cannot be connected"

Cause: a. The connection between head board and control board is out of order

b. Head board is damaged

Solution: a. Check whether the connection is abnormal or replace connection cable

b. Change the head board.

17. "Air pressure is insufficient"

Cause: a: Air supply equipment exception results in insufficient air pressure b:

Abnormal input of control board

c: Abnormal parameter settings or wiring error

Solution: a: Check whether the barometric pressure is normal

b: Short-circuit the input and gnd with tweezers and check if the input changes at "Assist settings" - "Input test" side

c: Check whether the parameters are set abnormally. In normal condition, the input is "normally closed". In the case of insufficient pressure, it should be opened, when the LED will light up for alarm.

18. "Electrical fault, please contact the manufacturer"

Cause: Hardware failure

Solution: Contact the manufacturer

19. "Grab line motor is not in place"

Cause: No motor limit signal is detected when motor press foot is reset

Solution: Check motor press foot related base for looseness; check whether the z signal limit signal input changes in the input test interface; check whether the parameters are improper.

20. "Input IO1 timeout error"

Cause: No signal is detected at this input port

Solution: Enter "input test" interface, and manually trigger the position input signal to check whether it can be detected

21. "Foot follow error"

Cause: Press foot zero input port detects no signal



Solution: Check the IO port set for follower press foot alarm in parameter setup software, manually trigger the IO port and check whether it can be detected



Appendix II: Quick Start Guide



(1) Start the machine

Install the equipment and connect the power supply. Turn or press the power switch to start the machine. Get into the main interface of processing as described in Section 2.2.1 after the logo appears. Where bottom thread winding is needed, refer to [Section 2.2.2](#).

(2) Set up processing file



Copy the .SLW processing file generated by the PC sewing editing software into the USB flash disk; insert the USB flash disk into the USB interface of equipment; click  -> 

->  in the main interface of processing to get into "USB flash disk" interface, click the name of the file to be processed to make it turn red, and click  to copy the file into memory.

Press  ->  to return to the main processing interface. Select the file to be processed on the left, when the processing pattern can be previewed in the middle of interface.

If "file capture" function is used to create processing file, see Chapter IV.

(3) Place the template

Put the fabric to be processed into the prepared template, click , and click  to make press frame get into rising state. Place the template under press frame, and click  so that the press frame can go down and press the template

(4) Align with reference

See [Section 2.2.4](#)

(5) Start the processing

Press start button in the main interface of processing, and the machine will start the processing based on pattern. Upon completion of processing, the system automatically returns to the reset origin or other set points.

Note:

1. If the processing is not performed for the first time (it has been copied into memory for reference alignment, and the automatic template recognition function has been enabled), only two steps will be needed: Place the template -> Start the processing

2. If other information prompts are displayed, refer to Appendix I.
3. If the processing is repeated after processing, you have to click other buttons upon completion of one processing cycle and enter parameter setup interface to cancel cycle processing.
- 4.

Please read this parts book before using the machine.
Please keep this parts book within easy reach for quick reference.

Parts list Intelligent Template Machine

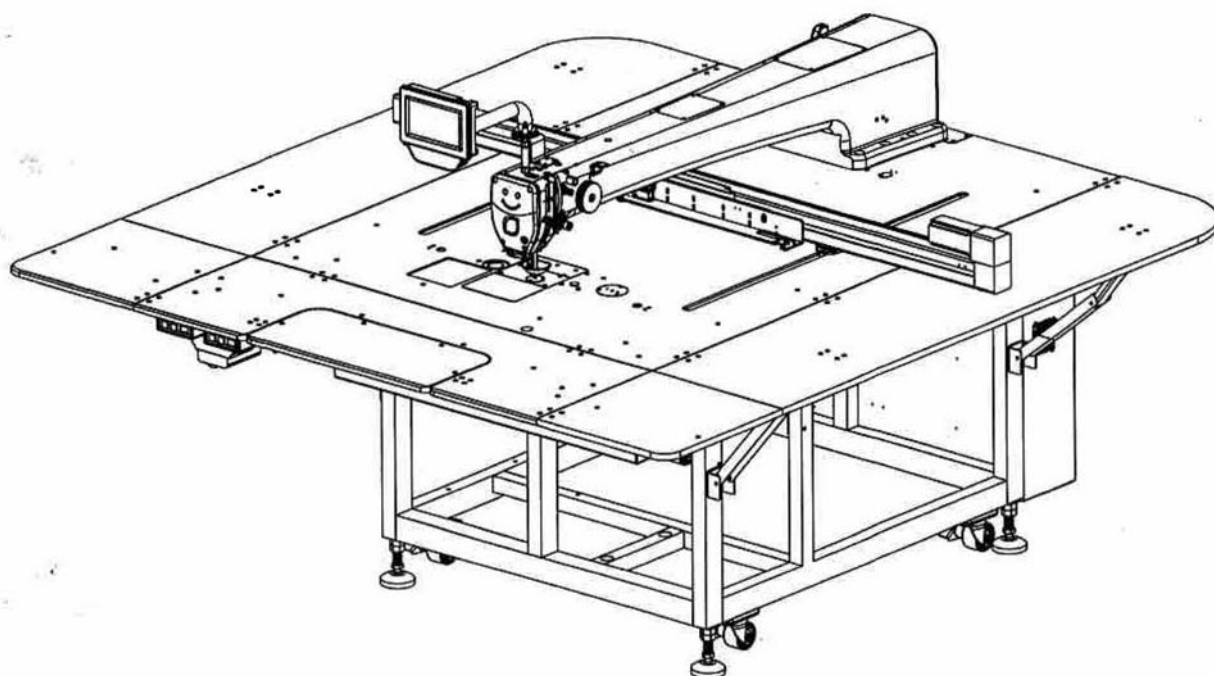

XMK002.8 星火电控模块 (90)

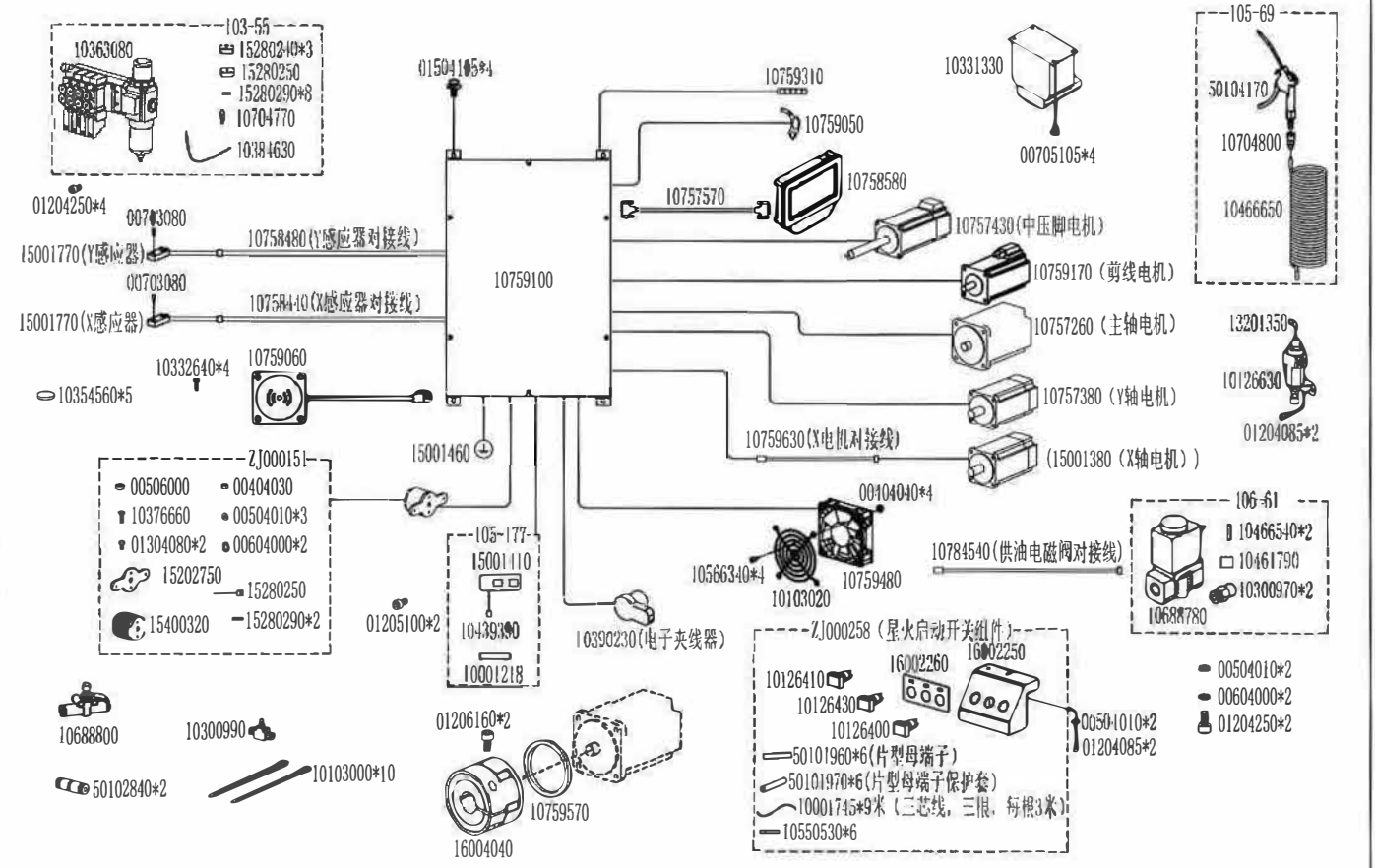

MK003.11 模组 (130) *
适用同步带模组机型

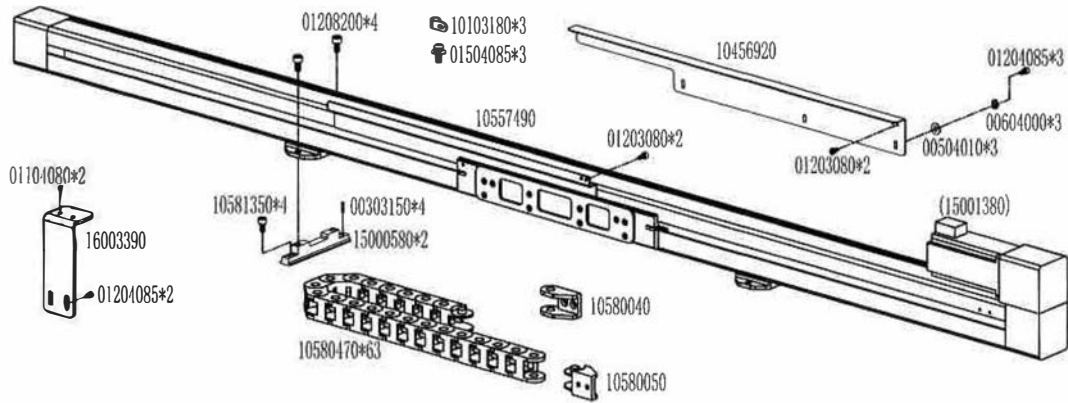

MK003.12 丝杆模组 (130) *
适用丝杆模组机型

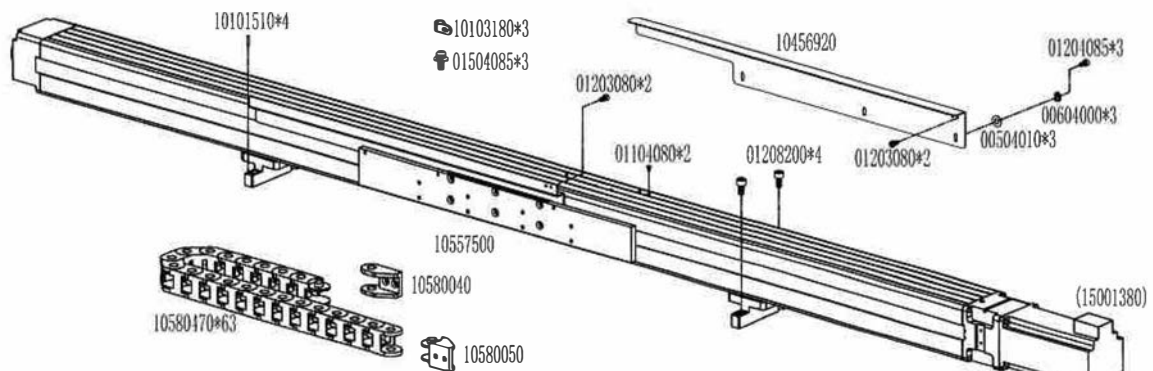

MK004.2 夹扣组件 (Z500) *
适用夹扣机型

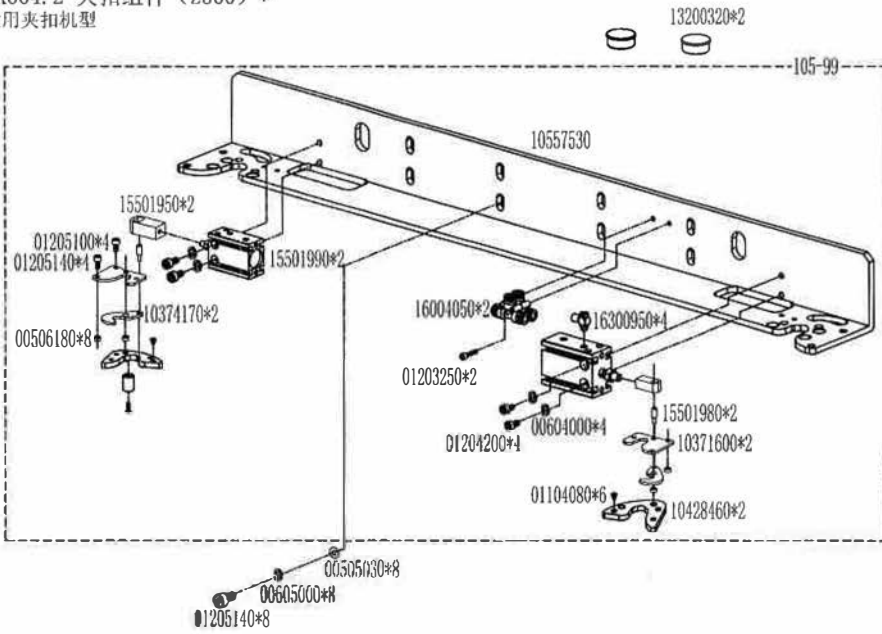

MK006.8 薄料针位模块 (S913)*
适用薄料机型

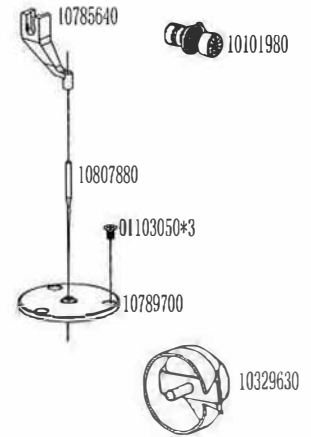

MK005.3 压框组件 (L800) *
适用压框机型

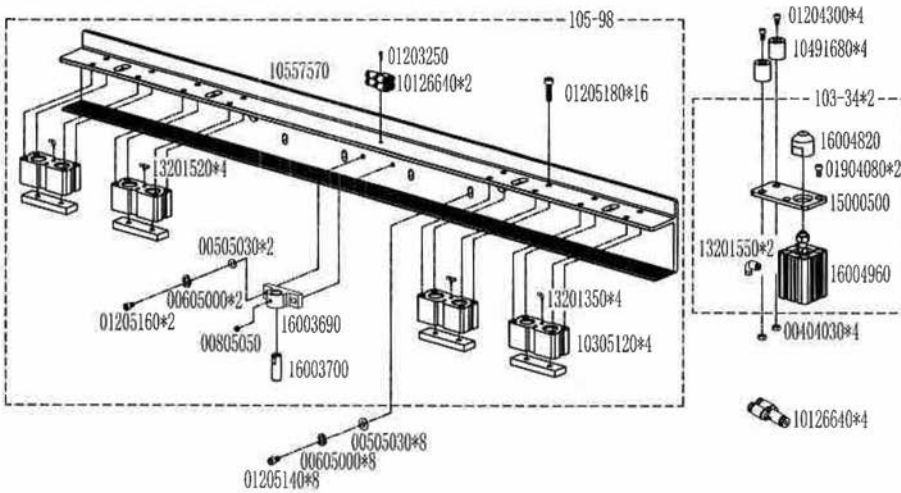

MK006.2 厚料针位模块*
适用厚料机型

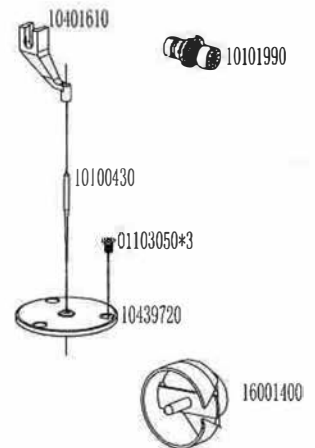

MK004.8 星火无停留启缝夹扣组件 (Z500-02) *
适用启缝机型

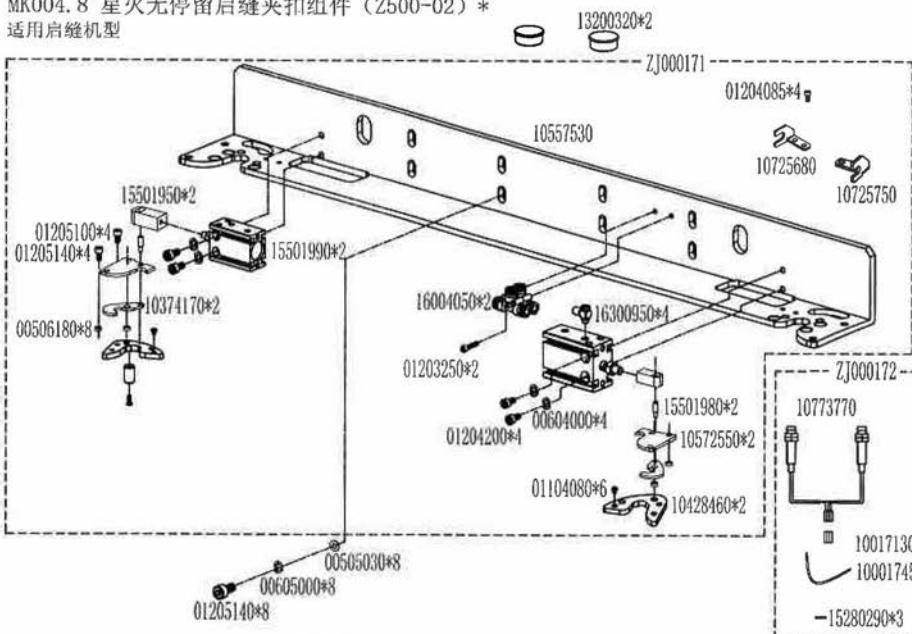

MK010.18 点位画笔装置*
适用点位画笔机型

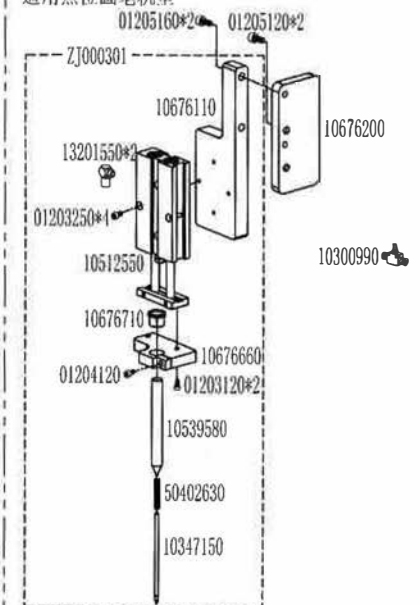

XMK007.3 大型模板机旋梭通用模块

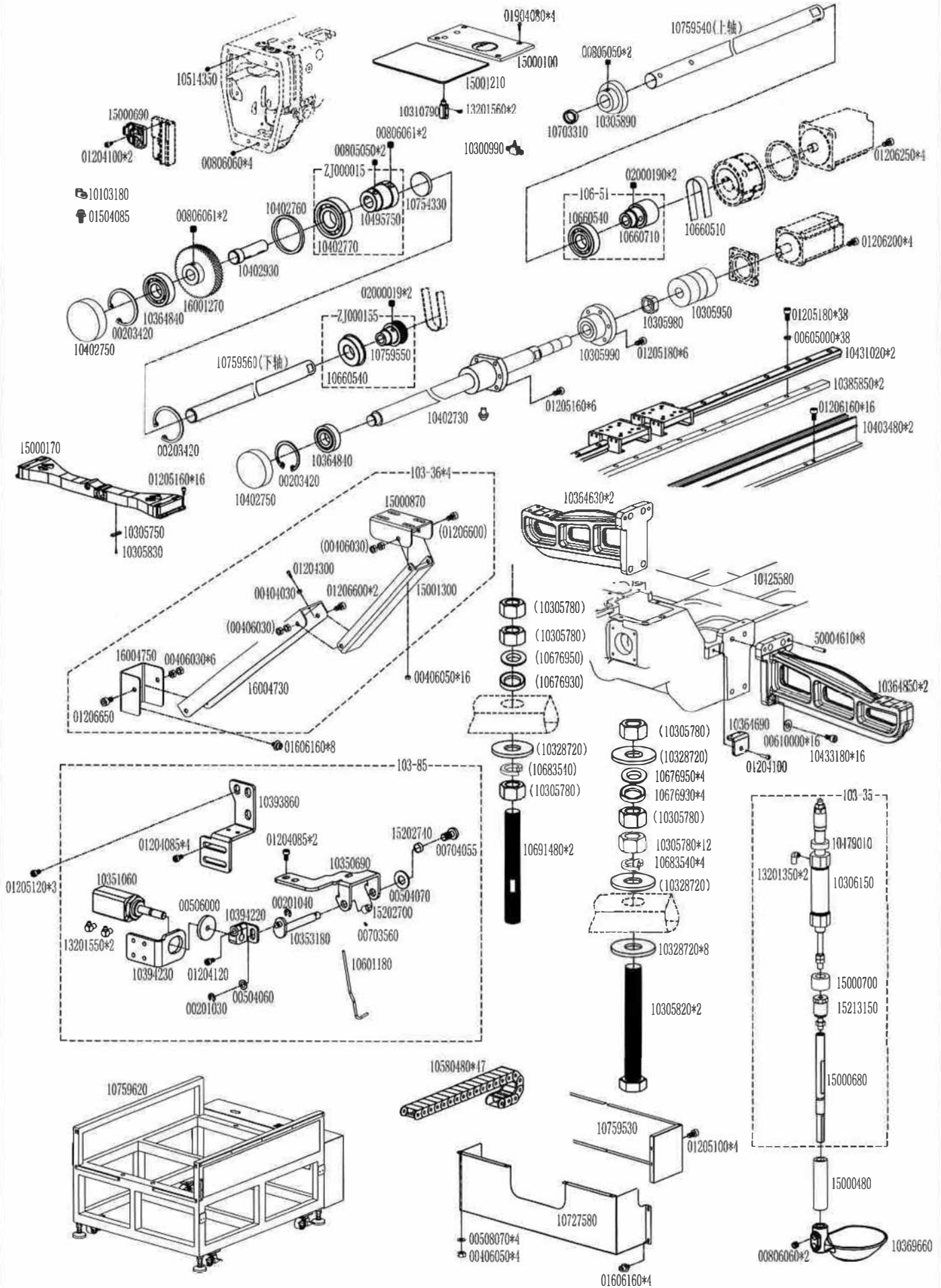

TC-12080

FULLY AUTOMATIC SEWING CONTROL SYSTEM
GENERATION-II



This machine may only be used by adequately trained operators after having fully read and understood the instruction manual.

Parts are subject in design changes without prior notice .



VETRON TYPICAL EUROPE GmbH
Clara-Immerwahr-Str. 6
67661 Kaiserslautern, Germany
Tel.: +49 6301 320 75-0
Fax: +49 6301 320 75-11

info@vetrontypical.com
www.vetrontypical.com